

SA-TMCB02 TABLE OF CONTENTS

SYSTEM OVERVIEW

System OverviewA1
 Global Services and Supporting ProgramsA2



PAN-TERM® TERMINALS

PAN-TERM® TerminalsB1
 Features and Benefits — **PAN-TERM®** TerminalsB2
 Selection Guide — **PAN-TERM®** Ring TerminalsB3
 Selection Guide — **PAN-TERM®** Fork TerminalsB4
 Performance RequirementsB5
 Part Number System for **PAN-TERM®** TerminalsB5
 Ring Terminal, Nylon InsulatedB6
 Ring Terminal, Nylon Insulated — Expanded InsulationB6
 Ring Terminal, Nylon Insulated — Funnel EntryB7
 Multiple Stud Terminal, Nylon InsulatedB7
 Ring Terminal, Vinyl Insulated — Funnel EntryB8
 Ring Terminal, Vinyl Expanded InsulationB9
 Multiple Stud Terminal, Vinyl Insulated — Funnel EntryB9
 Ring Terminal Tefzel InsulatedB10
 Heat Shink, Ring TerminalB10
 Ring Terminal, Heavy Duty, Nylon InsulatedB11
 Ring Terminal, Heavy Duty, Vinyl Insulated — Funnel EntryB11
 Ring Terminal, Large Wire, Vinyl InsulatedB12
 Ring Terminal, Large Wire, Vinyl Expanded InsulationB12
 Ring Terminal, Non-InsulatedB13
 Multiple Stud Terminal, Non-InsulatedB14
 Ring Terminal, Non-Insulated — High TemperatureB14
 Ring Terminal, Heavy Duty Non-InsulatedB15
 Ring Terminal, Large Wire Non-InsulatedB15
 Tubular Ring Terminal, Non-InsulatedB16
 Fork Terminal, Nylon InsulatedB17
 Fork Terminal, Nylon Insulated — Funnel EntryB17
 Fork Terminal, Vinyl Insulated — Funnel EntryB18
 Fork Terminal, Vinyl Insulated — Expanded InsulationB18
 Locking Fork Terminal, Nylon InsulatedB19
 Locking Fork Terminal, Nylon Insulated — Funnel EntryB19
 Locking Fork Terminal, Vinyl Insulated — Funnel EntryB20
 Locking Fork Terminal, Vinyl Insulated — Expanded InsulationB20
 Short Locking Fork Terminal, Nylon InsulatedB21
 Short Locking Fork Terminal, Nylon Insulated — Funnel EntryB21
 Short Locking Fork Terminal, Vinyl Insulated — Funnel EntryB22
 Flanged Fork Terminal, Nylon InsulatedB22
 Flanged Fork Terminal, Vinyl Insulated — Funnel EntryB22
 Fork Terminal, Non-InsulatedB23
 Flanged Fork Terminal, Non-InsulatedB23
 Locking Fork Terminal, Non-InsulatedB24
 Short Locking Fork Terminal, Non-InsulatedB24
 Heat Shrink, Fork TerminalB25
 Features and Benefits — **PAN-TERM®** Metric TerminalsB26
 Part Number System for **PAN-TERM®** Metric TerminalsB27
 Metric Ring Terminal, Nylon Insulated — Funnel EntryB27
 Metric Ring Terminal, Vinyl Insulated — Funnel EntryB27
 Metric Ring Terminal, Non-InsulatedB28
 Metric Fork Terminal, Nylon Insulated — Funnel EntryB28
 Metric Fork Terminal, Vinyl Insulated — Funnel EntryB28
 Metric Fork Terminal, Non-InsulatedB29

System Overview

Terminals

Disconnects

Splices

Ferrules

Compression Connectors

Crimping Tools

Mechanical Connectors

Grounding Connectors

Support Products

Technical Info

Index

System Overview

Metric Pin Terminal, Vinyl Insulated	B29
Metric Pin Terminal, Non-Insulated	B29
Plastic Box Terminal Kits	B30
Steel Kit Boxes	B30
Steel Slide Racks	B31
Industrial Maintenance Kits	B31

Terminals



PAN-TERM[®] DISCONNECTS

Disconnects

PAN-TERM[®] Disconnects	C1
Features and Benefits — PAN-TERM[®] Disconnects	C2-C3
Selection Guide — PAN-TERM[®] Disconnects	C4
Performance Requirements	C4
Part Number System for PAN-TERM[®] Disconnects	C5

Splices

SUPRA-GRIP[™] Female Disconnect, Nylon Fully Pre-Insulated	C5
DISCO-LOK[™] Female Disconnect, Nylon Fully Pre-Insulated	C5
Male/Female Coupler Nylon Fully Pre-Insulated — Funnel Entry	C6
Female Disconnect, Nylon Fully Pre-Insulated — Funnel Entry	C6
Female Disconnect, Nylon Fully Pre-Insulated — Funnel Entry	C7

Ferrules

DISCOGRIP[™] Male Disconnect, Premium Nylon Fully Pre-Insulated — Funnel Entry	C7
DISCOGRIP[™] Female Disconnect, Premium Nylon Fully Insulated — Funnel Entry	C7
Heat Shrink Disconnects, Fully Pre-Insulated — Funnel Entry	C7
Female Disconnect, Nylon Barrel Insulated — Funnel Entry	C8
Female Disconnect, Vinyl Barrel Insulated — Funnel Entry	C8
Female Disconnect, Vinyl Barrel Insulated — Butted Seam	C8

Compression Connectors

Female Disconnect, Non-Insulated — Metal Sleeve	C9
Female Disconnect, Non-Insulated — Butted Seam	C9
Pin Terminal, Vinyl Insulated — Funnel Entry	C9
Pin Terminal, Non-Insulated	C9
Right Angle Female Disconnect, Nylon Fully Insulated — Funnel Entry	C10
Right Angle Female Disconnect, Nylon Insulated — Funnel Entry	C10

Crimping Tools

Right Angle Female Disconnect, Non-Insulated — Metal Sleeve	C10
Right Angle Female Disconnect, Non-Insulated	C11
Piggyback Disconnect, Vinyl Insulated	C11
Disconnect Adapter, Non-Insulated	C11
Male Disconnect, Nylon Barrel Insulated — Funnel Entry	C12

Mechanical Connectors

Male Disconnect, Vinyl Barrel Insulated — Funnel Entry	C12
Male Disconnect, Non-Insulated — Butted Seam	C12
Selection Guide — Specialty Terminals	C13
Male Blade Adapter, Vinyl Insulated — Funnel Entry	C13
Male Blade Adapter, Non-Insulated	C13

Grounding Connectors

Features and Benefits — PAN-TERM[®] Metric Disconnects	C14
Part Number System for PAN-TERM[®] Metric Disconnects	C15
Female Metric Disconnects, Fully Insulated Nylon — Funnel Entry	C15
Female Metric Disconnects, Nylon Barrel Insulated — Funnel Entry	C15
Female Metric Disconnects, Vinyl Barrel Insulated — Funnel Entry	C15
Female Metric Disconnects, Non-Insulated	C16

Support Products

Male Metric Disconnects, Fully Insulated Nylon — Funnel Entry	C16
Male Metric Disconnects, Nylon Barrel Insulated — Funnel Entry	C16
Male Metric Disconnects, Non-Insulated	C16
Piggyback Metric Disconnects, Vinyl Barrel Insulated	C16



PAN-TERM[®] SPLICES

Technical Info

PAN-TERM[®] Splices	D1
Features and Benefits — PAN-TERM[®] Splices and Wire Joints	D2
Features and Benefits — PAN-TERM[®] Splices	D3
Selection Guide — PAN-TERM[®] Splices and Wire Joints	D4
Part Number System for PAN-TERM[®] Splices	D4
Part Number System for PAN-TERM[®] Wire Joints	D4
Butt Splice, Nylon Insulated	D5

Index

Butt Splice, Vinyl Insulated	D5
Butt Splice, Non-Insulated	D5
Parallel Splice, Nylon Insulated	D6
Parallel Splice, Non-Insulated	D6
Wire Joint, Nylon Insulated	D6
Wire Joint, Non-Insulated	D7
Heat Shrink, Butt Splices	D7
Metric Butt Splice, Vinyl Insulated	D7
Metric Butt Splice, Non-Insulated	D8
Metric Wire Joints, Nylon Insulated	D8



PAN-TERM® FERRULES

PAN-TERM® Ferrules	E1
Part Number System for PAN-TERM® Ferrules	E2
Features and Benefits — PAN-TERM® Ferrules	E2
Selection Guide — PAN-TERM® Ferrules	E3
Insulated Ferrules — Single Wire DIN End Sleeve	E4
Insulated Ferrules — Single Wire French End Sleeve	E5
Insulated Ferrules — Twin Wire DIN End Sleeve	E6
Ferrules, Non-Insulated	E6-E7
Ferrule Assortment Kits	E8



PAN-LUG™ COMPRESSION CONNECTORS

PAN-LUG™ Compression Connectors	F1
Features and Benefits — PAN-LUG™ Compression Connectors	F2
Selection Guide — PAN-LUG™ Copper Compression Connectors for Copper Code Conductor	F3
Selection Guide — PAN-LUG™ Copper Compression Connectors for Copper Code and/or Flex Conductor	F4
Selection Guide — PAN-LUG™ Aluminum Compression Connectors for Aluminum or Copper Code Conductor	F5
Part Number System for PAN-LUG™ Compression Lugs	F5
Code Conductor, One-Hole, Short Barrel with Window Lug	F6-F7
Code Conductor, One-Hole, Short Barrel with Window Lug, 45° Angle	F8-F9
Code Conductor, One-Hole, Short Barrel with Window Lug, 90° Angle	F10-F11
Code Conductor, One-Hole, Standard Barrel with Window Lug	F12-F13
Code Conductor, One-Hole, Standard Barrel with Window Lug, 45° Angle	F14-F15
Code Conductor, One-Hole, Standard Barrel with Window Lug, 90° Angle	F16-F17
Code Conductor, One-Hole, Standard Barrel with Window, Narrow Tongue Lug	F18-F19
Code Conductor, Short Blank Tongue, Standard Barrel with Window Lug	F20
Code Conductor, One-Hole, Long Barrel Lug	F21-F22
Code Conductor, One-Hole, Long Barrel Lug, 45° Angle	F23-F24
Code Conductor, One-Hole, Long Barrel Lug, 90° Angle	F25-F26
Code Conductor, One-Hole, Long Barrel with Window Lug	F27
Code Conductor, One-Hole, Long Barrel with Window Lug, 45° Angle	F28
Code Conductor, One-Hole, Long Barrel with Window Lug, 90° Angle	F29
Code Conductor, One-Hole, Long Barrel with Corona Relief Taper Lug	F30
Code Conductor, Two-Hole, Standard Barrel with Window Lug	F31-F32
Code Conductor, Two-Hole, Standard Barrel with Window Lug, 45° Angle	F33-F34
Code Conductor, Two-Hole, Standard Barrel with Window Lug, 90° Angle	F35-F36
Code Conductor, Two-Hole, Standard Barrel with Window, Narrow Tongue Lug	F37
Code, Two-Hole, Standard Barrel with Window, Narrow Tongue Lug, 45°	F38
Code, Two-Hole, Standard Barrel with Window, Narrow Tongue Lug, 90°	F38
Code Conductor, Long Blank Tongue, Standard Barrel with Window Lug	F39
Code Conductor, Two-Hole, Long Barrel Lug	F40-F41
Code Conductor, Two-Hole, Long Barrel Lug, 45° Angle	F42-F43
Code Conductor, Two-Hole, Long Barrel Lug, 90° Angle	F44-F45
Code Conductor, Two-Hole, Long Barrel with Window Lug	F46-F48
Code Conductor, Two-Hole, Long Barrel with Window Lug, 45° Angle	F49-F51
Code Conductor, Two-Hole, Long Barrel with Window Lug, 90° Angle	F52-F54

System Overview

Terminals

Disconnects

Splices

Ferrules

Compression Connectors

Crimping Tools

Mechanical Connectors

Grounding Connectors

Support Products

Technical Info

Index

System Overview	Code Conductor, Two-Hole, Long Barrel with Window, Narrow Tongue Lug	F54
	Code Conductor, Two-Hole, Long Barrel with Corona Relief Taper Lug	F55
	Code Conductor, Blank Tongue, Long Barrel Lug	F56
	Code Conductor, Blank Tongue, Long Barrel with Window Lug	F57
Terminals	Code Conductor, Short Barrel, Butt Splice	F58
	Code Conductor, Standard Barrel, Butt Splice	F59
	Code Conductor, Long Barrel, Butt Splice	F60
	Code Conductor, Long Barrel with Corona Relief Taper Splice	F61
	Code Conductor, Long Barrel, T Splice	F62
	Code Conductor, Parallel Splice	F63
Disconnects	Flex Conductor, One-Hole, Standard Barrel with Window Lug	F64-F65
	Flex Conductor, One-Hole, Standard Barrel with Window Lug, 45° Angle	F66-F67
	Flex Conductor, One-Hole, Standard Barrel with Window Lug, 90° Angle	F68-F69
	Flex Conductor, One-Hole, Standard Barrel with Window, Narrow Tongue Lug	F70
Splices	Flex, One-Hole, Standard Barrel with Window, Narrow Tongue Lug, 45°	F71
	Flex, One-Hole, Standard Barrel with Window, Narrow Tongue Lug, 90°	F72
	Flex Conductor, One-Hole, Standard Barrel with Window, Flared Lug	F73-F74
	Flex, One-Hole, Standard Barrel with Window, Flared Lug, 45° Angle	F75-F76
	Flex, One-Hole, Standard Barrel with Window, Flared Lug, 90° Angle	F77-F78
	Flex Conductor, One-Hole, Long Barrel with Window Lug	F79
	Flex Conductor, One-Hole, Long Barrel with Window Lug, 45° Angle	F80
Ferrules	Flex Conductor, One-Hole, Long Barrel with Window Lug, 90° Angle	F81
	Flex Conductor, Two-Hole, Standard Barrel with Window Lug	F82-F83
	Flex Conductor, Two-Hole, Standard Barrel with Window Lug, 45° Angle	F84-F85
	Flex Conductor, Two-Hole, Standard Barrel with Window Lug, 90° Angle	F86-F87
	Flex Conductor, Two-Hole, Standard Barrel with Window, Narrow Tongue Lug	F88
Compression Connectors	Flex, Two-Hole, Standard Barrel with Window, Narrow Tongue Lug, 45°	F89
	Flex, Two-Hole, Standard Barrel with Window, Narrow Tongue Lug, 90°	F90
	Flex Conductor, Two-Hole, Long Barrel with Window Lug	F91-F92
	Flex Conductor, Two-Hole, Long Barrel with Window Lug, 45° Angle	F92-F93
	Flex Conductor, Two-Hole, Long Barrel with Window Lug, 90° Angle	F94-F95
Crimping Tools	Flex Conductor, Two-Hole, Long Barrel, Flared Lug	F95-F96
	Flex Conductor, Two-Hole, Long Barrel, Flared Lug, 45° Angle	F97-F98
	Flex Conductor, Two-Hole, Long Barrel, Flared Lug, 90° Angle	F99-F100
	Flex Conductor, Standard Barrel, Flared, Butt Splice	F101
	Code/Flex Conductor, with Window, In-Line Reducing Splice Kit	F102-F103
	Code/Flex Conductor, with Window, In-Line Reducing Splice	F104
Mechanical Connectors	Code Conductor, Thin Wall, CTAP	F105
	Code Conductor, Heavy Duty, CTAP	F106
	Black Covers for Copper CTAPs and Aluminum HTAPs	F106
	Code/Flex Conductor HTAP Kit	F107
	Code/Flex Conductor HTAP	F108
	Clear Covers for HTCT HTAPs	F109
	PANDUIT® Custom Copper Compression Lugs for Special Applications	F110-F112
Grounding Connectors	Code Conductor, One-Hole, Aluminum Lug	F113
	Code Conductor, Two-Hole, Aluminum Lug	F114
	Belleville Compression Washers	F115
	Code Conductor, Aluminum Splice	F115
	Code Conductor, Aluminum Reducing Splice	F116
	Code Conductor, Aluminum Bi-Metallic Pin Connector	F117
	Code Conductor, Aluminum HTAP	F118
	Joint Compounds	F118
Technical Info		
	Crimping Tools	G1
	Crimping Guidelines for PANDUIT® PAN-TERM® Terminals, Disconnects, Splices and Wire Joints	G2
	Crimping Guidelines for PANDUIT® PAN-LUG™ Compression Lugs and Splices	G3
	Crimping Guidelines for PANDUIT® PAN-LUG™ Copper HTAP and Clear Cover System	G4
	Selection Guide — Compression Connector Tools	G5-G7
Index	Manual Hand Tools	G8

CRIMPING TOOLS

CONTOUR CRIMP™ Controlled Cycle Tools	G8-G9
Controlled Cycle Crimping Tools — Ferrule End Sleeve	G10
Controlled Cycle Crimping Tools — In-Line	G10
Pneumatic Crimping Tool	G11
Die Type, Manual, Crimping Tool	G11
CD-720 Crimping Dies	G12
Die Type, Manual, Crimping Tool and Die Kits	G12
Die Type, Manual Hydraulic, 14 Ton, Crimping Tool	G13
Die Type, Battery Powered Hydraulic, 6 Ton, Crimping Tool with Closed Head	G14
Die Type, Battery Powered Hydraulic, 6 Ton, Crimping Tool with Open "C-Head"	G15
CD-2001 and CDM-2001 Crimping Dies	G16
Die Type, Battery Powered Hydraulic, 12 Ton, Crimping Tool	G17
Die Type, Battery Powered Hydraulic, 14 Ton, Crimping Tool	G18
Die Type, Battery Powered Hydraulic, 15 Ton, Crimping Tool	G19
Die Type, Remote Hydraulic, 14 Ton, Crimp Head	G20
Die Type, Remote Hydraulic, 15 Ton, Crimp Head	G21
Hydraulic Pump and Accessories, Electric, 10,000 PSI	G22
Die Type, Remote Hydraulic, 10.5 Ton, Crimp Head	G23
Hydraulic Pump and Accessories, Electric, 7,500 PSI	G24
CD-920 and CDM-920 Crimping Dies	G25
CD-940 Crimping Dies	G26
UNI-DIE™ Dieless, Manual Hydraulic, 6.2 Ton, Crimping Tool	G27
UNI-DIE™ Dieless, Battery Powered Hydraulic, 6.2 Ton, Crimping Tool, 12 VDC	G28
UNI-DIE™ Dieless, Battery Powered Hydraulic, 6.2 Ton, Crimping Tool, 14.4 VDC	G29
UNI-DIE™ Dieless, Remote Hydraulic, 6.2 Ton, Crimp Head	G30
UNI-DIE™ Dieless, Remote Hydraulic, 4.7 Ton, Crimp Head	G30
Pressure Gauges	G31
Accessories for Battery Powered Hydraulic Crimping Tools	G32
Cable Stripping Tools	G32



PAN-LUG™ MECHANICAL CONNECTORS

PAN-LUG™ Mechanical Connectors	H1
Features and Benefits — PAN-LUG™ Mechanical Connectors	H2
Selection Guide — PAN-LUG™ Mechanical Connectors, Cast Copper	H3
Selection Guide — PAN-LUG™ Mechanical Connectors, Stamped and Formed	H4
Selection Guide — PAN-LUG™ Mechanical Connectors, Aluminum	H5
Selection Guide — PAN-LUG™ Mechanical Connectors, Split Bolts and Multi-Taps	H6
Split Bolt, Copper	H7
Split Bolt, Copper, Tin Plated	H8
Split Bolt, Aluminum	H9
Two Bolt Connector, Bronze	H9
Two Bolt Connector, Bronze, Tin Plated	H10
One-Hole, Straight Tongue, Barrel Post Lug	H11
One-Hole, Straight Tongue, Tin Plated, Barrel Post Lug	H11
One-Hole, Straight Tongue Lug	H12
One-Hole, Straight Tongue Lug with Internal Pressure Plate	H12
One-Hole, Straight Tongue, Flag Lug	H13
One-Hole, Straight Tongue, 90° Lug	H13
Two-Hole, Straight Tongue Lug	H14
Two-Hole, Straight Tongue Lug with Internal Pressure Plate	H14
Two-Hole, Straight Tongue Lug with NEMA Hole Sizes and Spacing	H15
Two-Hole, Straight Tongue, Tandem Set Screw Lug	H15
Two-Hole, Straight Tongue, Two Barrel Lug	H16
Two-Hole, Straight Tongue, Two Barrel, Tin Plated Lug	H16
Two Set Screw Splice with Internal Pressure Plate	H17
Two Set Screw Splice	H17
One-Hole, Straight Fixed Tongue Lug	H18
One-Hole, Straight Fixed Tongue, Tin Plated Lug	H18
One-Hole, Straight Floating Tongue Lug	H19
Two-Hole, Straight Floating Tongue Lug	H20

System Overview

Terminals

Disconnects

Splices

Ferrules

Compression Connectors

Crimping Tools

Mechanical Connectors

Grounding Connectors

Support Products

Technical Info

Index

System Overview	One-Hole, Offset Floating Tongue LugH21
	One-Hole, Offset Floating Tongue, Two Barrel LugH22
	Two-Hole, Offset Floating Tongue LugH22
Terminals	One-Hole, Single Barrel LugH23
	Two-Hole, Single Barrel LugH23
	One-Hole, Two Barrel LugH24
	One-Hole, Vertical Two Barrel LugH24
Disconnects	Two-Hole, Two Barrel LugH25
	Two-Hole, Vertical Two Barrel LugH25
	Two-Hole, Three Barrel LugH26
	Two-Hole, Vertical Three Barrel LugH26
	Four-Hole, Three Barrel LugH27
	Two-Hole, Vertical Four Barrel LugH27
Splices	Four-Hole, Four Barrel LugH28
	Transformer Lug KitH29
	Splicer/ReducerH29
	Insulation Piercing ConnectorH30
Ferrules	Multi-Tap Connector with Clear Insulation, Single-Sided EntryH30
	Multi-Tap Connector with Clear Insulation, Double-Sided EntryH31
	In-Line Splicer/Reducer with Clear InsulationH32
	Belleville Compression WashersH33
	Joint CompoundsH33
	Guidelines for Installing Connectors on Aluminum Conductor CableH34



PAN-LUG™ GROUNDING CONNECTORS

Compression Connectors	PAN-LUG™ Grounding ConnectorsJ1
	Features and Benefits — PAN-LUG™ Grounding ConnectorsJ2
Crimping Tools	Selection Guide — PAN-LUG™ Grounding ConnectorsJ3-J4
	Service Post Connector, Male Stud, Single Conductor, BronzeJ5
	Service Post Connector, Male Stud, Two Conductor, BronzeJ6
	Service Post Connector, Female Thread, Single Conductor, BronzeJ7
	Service Post Connector, Female Thread, Two Conductor, BronzeJ8
	Grounding Clamp, U-Bolt, BronzeJ9
	Grounding Clamp, U-Bolt, for Two Cables, BronzeJ10
	Grounding Clamp for Water Pipes, BronzeJ10
Mechanical Connectors	Grounding Clamp for Water Pipe with Copper Strap, BronzeJ10
	Grounding Clamp for Conduit, BronzeJ11
	Grounding Clamp for Water Pipes, AluminumJ11
	Grounding Rod Clamp, BronzeJ11
	Grounding Clamp for Flat Surfaces, BronzeJ12
	Grounding Clamp with Spacer for Flat Surfaces, BronzeJ12



SUPPORT PRODUCTS

Grounding Connectors	Support ProductsK1
	Continuously Molded Reel-Fed TERMO™ Terminals, Butt Splices and DISCO™ – DISCOGRIP™ Continuously Molded Reel-Fed DisconnectsK2
Support Products	Nylon Insulated Terminals with Insulation Grip Sleeve (Funnel & Non-Funnel Entry Types)K3
	Performance RequirementsK3
	Part Number System for REEL SMART™ TerminalsK3
	Ring Terminals, Nylon Insulated — Non-Funnel EntryK4
	Ring Terminals, Nylon Insulated — Funnel EntryK4
	Ring Terminals, Vinyl Insulated — Funnel EntryK5
	Ring Terminals, Vinyl Insulated — Multiple StudK5
	Ring Terminals, Nylon Insulated — Heavy DutyK6
Technical Info	Ring Terminals, Vinyl Insulated — Heavy DutyK6
	Fork Terminals, Nylon Insulated — Non-Funnel EntryK7
	Fork Terminals, Nylon Insulated — Funnel EntryK7
Index	Fork Terminals, Vinyl Insulated — Funnel EntryK8
	Locking Fork Terminals, Nylon Insulated — Non-Funnel EntryK8

Locking Fork Terminals, Nylon Insulated — Funnel Entry	K9
Locking Fork Terminals, Vinyl Insulated — Funnel Entry	K9
Short Locking Fork Terminals, Nylon Insulated — Non-Funnel Entry	K10
Short Locking Fork Terminals, Nylon Insulated — Funnel Entry	K10
Short Locking Fork Terminals, Vinyl Insulated — Funnel Entry	K11
Flanged Fork Terminals, Nylon Insulated — Non-Funnel Entry	K11
Flanged Fork Terminals, Nylon Insulated — Funnel Entry	K12
Flanged Fork Terminals Vinyl Insulated — Funnel Entry	K12
Pin Terminals, Vinyl Insulated	K13
Male Blade Adapters, Vinyl Insulated — Funnel Entry	K13
Butt Splices Nylon Insulated and Premium Grade Nylon	K13
Features and Benefits — REEL SMART™ Disconnects	K14-K15
Part Number System for REEL SMART™ Disconnects	K15
SUPRA-GRIP™ Female Disconnects, Nylon Fully Insulated	K16
DISCO-LOK™ Female Disconnects, Nylon Fully Insulated	K16
Female Disconnects, Nylon Fully Insulated	K17
DISCO™ Female Disconnects, Nylon Fully Insulated — Expanded Wire Entry	K17
DISCO™ Female Disconnects, Nylon Fully Insulated — Right Angle	K18
DISCO™ Female Disconnects, Vinyl Barrel Insulated	K18
DISCOGRIP™ Female Disconnects, Fully Insulated	K19
DISCOGRIP™ Male Disconnects, Fully Insulated	K19
DISCO™ Male Disconnects, Nylon Fully Insulated	K20
DISCO™ Male Disconnects, Nylon Fully Insulated — Expanded Wire Entry	K20
DISCO™ Male Disconnects, Nylon Barrel Insulated	K21
DISCO™ Male Disconnects, Vinyl Barrel Insulated	K21
REEL SMART™ Tooling	K22
Electric Flywheel Presses	K22
Die Sharpening Kits	K22
Die Information Chart	K23-K24
Thin Wall Polyolefin Heat Shrink	K25
Thin Wall Polyolefin Heat Shrink — Convenience Packs	K26
Crystal Clear PVC Heat Shrink	K27
Thick Wall Polyolefin Heat Shrink	K27
Heat Shrink End Caps	K28
PANAĀCEA® LS7 Hand-Held Thermal Transfer Printer and Accessories	K29
VIPER™ LS6 Portable Thermal Transfer Printer and Accessories	K29
PAN-QUIK™ LS3E Hand-Held Dot Matrix Printer and Accessories	K30
TDP43M Thermal Transfer Desktop Printer and Accessories	K30
Thermal Transfer Ribbons for use with the TDP43M Thermal Transfer Desktop Printer	K30
PAN-MARK® for WINDOWS Labeling Software	K31
EASY-MARK™ Labeling Software	K31
Self-Laminating Labels for Wires and Cables	K32
Self-Laminating Labels for Laser/Ink Jet Desktop Printers	K32
Self-Laminating Labels for TDP43M Thermal Transfer Desktop Printers	K32
Cable Marking Cassettes for PANAĀCEA® LS7 Hand-Held Thermal Transfer Printer	K33
Self-Laminating Labels for VIPER™ LS6 Portable Thermal Transfer Printer	K33
Self-Laminating Labels for PAN-QUIK™ LS3E Hand-Held Dot Matrix Printer	K33
Heat Shrink Labels for Wires and Cables	K34
Heat Shrink Labels for Thermal Transfer Desktop Printers	K34
Heat Shrink Labels for VIPER™ LS6 Portable Thermal Transfer Printer	K34
Heat Shrink Labels for PAN-QUIK™ LS3E Hand-Held Dot Matrix Printer	K35
Wire Size Selection Guide	K35
PAN-TY® Cable Ties	K36
Hot Stamping — Custom Printed Cable Ties	K36
DOME-TOP® Barb Ty Cable Ties	K37
DOME-TOP® Barb Ty Marker & Flag Ties	K37
DURA-TY™ Cable Ties	K38
CONTOUR-TY® Cable Ties	K38
BELT-TY™ In-Line Cable Tie	K39
TAK-TY® Hook & Loop Cable Ties	K39
TAK-TAPE™ Hook & Loop Strips	K40

System Overview
Terminals
Disconnects
Splices
Ferrules
Compression Connectors
Crimping Tools
Mechanical Connectors
Grounding Connectors
Support Products
Technical Info
Index

System Overview

<i>ULTRA-CINCH</i> ™ Hook & Loop Ties	.K40
Hand Operated Tools — Tool-Controlled Tension and Cut-Off	.K41
Hand Operated Tools — Installer-Controlled Tension and Cut-Off	.K41

TECHNICAL SPECIFICATION AND SELECTION INFORMATION

Terminals

Technical Specification and Selection Information	.L1
Testing Agencies and Test Standards	.L1
Tooling Selection Guide for <i>PANDUIT</i> ® Terminals, Splices and Disconnects	.L2-L4
Tooling Selection Guide for <i>PANDUIT</i> ® Tubular Ring Terminals	.L5
Tooling Selection Guide for <i>PANDUIT</i> ® Ferrules	.L5

Disconnects

Installation Tooling and Die Selections for:	
Types LCAS and SCSS	.L6-L7
Types LCA, LKAN, LCD, LCDN and SCS	.L8-L11
Types LCB, LCBN, LCC, LCCN and SCL	.L12-L15
Types LCBH, LCCH and SCH	.L16-L17

Splices

Type SCT	.L18-L19
Type PS	.L20-L21
Types LCAX, LCAXN, LCBX, LCDX, LCDXN, LCCX, LCEX and LCJX	.L22-L23
Types LCAF, LCCF and SCSF	.L24-L25

Ferrules

Type RSC In-Line Reducing Splice	.L26-L31
Type CTAPF	.L32-L33
Type CTAP	.L34
Type HTCT	.L35
Type SAR	.L36
Type HTAP	.L37
Type BPC	.L38-L39
Types LAA, LAB and SA	.L40-L41

Compression Connectors

Recommended Termination Hardware	.L42
Conductor Sizes	.L43-L45
Common Conductor Sizes and Strandings Reference Chart	.L46-L47
Equivalent Tables Fractional Inches/Decimal Inches/Millimeters	.L48
Stud Size Chart (Inches)	.L48

Crimping Tools

INDEX

Mechanical Connectors

Index	.M1-M21
Related Catalogs	.M22

Grounding Connectors

Support Products

Technical Info

Index

CATALOG HIGHLIGHTS

- **Table of Contents** ([see pages i - viii](#))
 - Complete product listing by family
- **Color Coded Tabs**
 - Quick and easy identification of sections
- **Part Number Index is shown on** [pages M1 - M21](#)
 - Complete part number listing
 - Installation Tooling and Die Selection Chart page references are included
- **Features and Benefits Pages are shown at the beginning of each section**
 - Highlight unique features of PANDUIT® products
- **Product Selection Guides are shown at the beginning of each section**
 - Quick way to identify the appropriate product
 - Page references are included
- **Installation Instructions**
 - PAN-TERM® Terminals, Disconnects, Splices and Wire Joints crimping instructions are shown on [page G2](#)
 - PAN-LUG™ Compression Lugs and Splices crimping instructions are shown on [page G3](#)
 - PAN-LUG™ Copper HTAP and Clear Cover System crimping instructions are shown on [page G4](#)
 - Aluminum Mechanical Lug installation instructions are shown on [page H34](#)
- **Installation Tooling and Die Selection Charts are shown on** [pages L2 - L41](#)
 - Wire strip lengths are shown on these charts
- **Testing Agencies and Test Standards are shown on** [page L1](#)
- **Conductor Charts are shown on** [pages L43 - L47](#)
- **Stud Size Chart is shown on** [page L48](#)
- **Recommended Termination Hardware is shown on** [page L42](#)
- **Support Products are shown on** [pages K1 - K41](#)

CATALOG REFERENCE INFORMATION

PANDUIT® TERMINATION SOLUTIONS		Code
Selection Guide — PAN-LUG® Copper Compression Connectors for Copper Code Conductor		
1 Stud Hole Lug	Proportioned Lug	CCP101 20 AWG 380 20 100 25.4 2.5 0.75 CCP102 22 AWG 380 22 100 25.4 2.5 0.75
	Standard Barrel with Proportioned Window	CCP140 20 AWG 380 20 100 25.4 1.75 1.75 CCP141 22 AWG 380 22 100 25.4 1.75 1.75 CCP142 24 AWG 380 24 100 25.4 1.75 1.75 CCP143 26 AWG 380 26 100 25.4 1.75 1.75
	Long Barrel with Proportioned Window	CCP140 20 AWG 380 20 100 25.4 1.75 1.75 CCP141 22 AWG 380 22 100 25.4 1.75 1.75 CCP142 24 AWG 380 24 100 25.4 1.75 1.75 CCP143 26 AWG 380 26 100 25.4 1.75 1.75
	Long Barrel with Expansion Window	CCP140 20 AWG 380 20 100 25.4 1.75 1.75 CCP141 22 AWG 380 22 100 25.4 1.75 1.75 CCP142 24 AWG 380 24 100 25.4 1.75 1.75 CCP143 26 AWG 380 26 100 25.4 1.75 1.75
2 Stud Hole Lug	Proportioned Lug	CCP201 20 AWG 380 20 100 25.4 2.5 0.75 CCP202 22 AWG 380 22 100 25.4 2.5 0.75
	Standard Barrel with Expansion Window	CCP240 20 AWG 380 20 100 25.4 1.75 1.75 CCP241 22 AWG 380 22 100 25.4 1.75 1.75 CCP242 24 AWG 380 24 100 25.4 1.75 1.75 CCP243 26 AWG 380 26 100 25.4 1.75 1.75
	Long Barrel with Expansion Window	CCP240 20 AWG 380 20 100 25.4 1.75 1.75 CCP241 22 AWG 380 22 100 25.4 1.75 1.75 CCP242 24 AWG 380 24 100 25.4 1.75 1.75 CCP243 26 AWG 380 26 100 25.4 1.75 1.75
	Long Barrel with Proportioned Window	CCP240 20 AWG 380 20 100 25.4 1.75 1.75 CCP241 22 AWG 380 22 100 25.4 1.75 1.75 CCP242 24 AWG 380 24 100 25.4 1.75 1.75 CCP243 26 AWG 380 26 100 25.4 1.75 1.75
Butt Splices	Standard Barrel	CS200 300 30 100 25.4 2.5 0.75
	Long Barrel	CS200 300 30 100 25.4 2.5 0.75
	Long Barrel with Expansion Window	CS200 300 30 100 25.4 2.5 0.75
T Splices	Standard Barrel	CS100 150 15 100 25.4 2.5 0.75
	Long Barrel	CS100 150 15 100 25.4 2.5 0.75
Panduit Splices	CS100 150 15 100 25.4 2.5 0.75	
CTAPs	CTAP1 150 15 100 25.4 2.5 0.75 CTAP2 150 15 100 25.4 2.5 0.75	

Product Selection Guide

- Found within the first five pages of each section
- Provides a quick and easy method to select the proper connector to meet the specific application requirements

Conductor Type

Stud Hole Configuration

Barrel Configuration

Product Family and Page Number

PANDUIT® TERMINATION SOLUTIONS		Code																		
NEW! PAN-LUG® One-Hole, Long Barrel with Window Lug																				
For Use with Standard Copper Conductors																				
Type: LC6W																				
<ul style="list-style-type: none"> • Insulative window is made of polyethylene material • One-hole design, tested to 7000V, 0.1μF dielectric • Insulative die cast housing for proper clamp die installation • Can be used in metal enclosures 	<ul style="list-style-type: none"> • All sizes are CSA Certified for use with standard copper conductors • Insulated terminals — meets NEMA 3B2-1 • Heavy duty design for network systems 																			
Part Number	Conductor Size (AWG)	Stud Hole Dia (mm)	Window Dia (mm)	Window Dia (in)	Window Dia (mm)	Window Dia (in)	Window Dia (mm)	Window Dia (in)	Window Dia (mm)	Window Dia (in)	Window Dia (mm)	Window Dia (in)	Window Dia (mm)	Window Dia (in)	Window Dia (mm)	Window Dia (in)	Window Dia (mm)	Window Dia (in)		
LC6W0400	14	13.0	14.0	12.5	12.5	0.492	12.5	0.492	12.5	0.492	12.5	0.492	12.5	0.492	12.5	0.492	12.5	0.492	12.5	0.492
LC6W0500	16	13.0	14.0	12.5	12.5	0.492	12.5	0.492	12.5	0.492	12.5	0.492	12.5	0.492	12.5	0.492	12.5	0.492	12.5	0.492
LC6W0600	18	13.0	14.0	12.5	12.5	0.492	12.5	0.492	12.5	0.492	12.5	0.492	12.5	0.492	12.5	0.492	12.5	0.492	12.5	0.492
LC6W0800	20	13.0	14.0	12.5	12.5	0.492	12.5	0.492	12.5	0.492	12.5	0.492	12.5	0.492	12.5	0.492	12.5	0.492	12.5	0.492
LC6W1000	22	13.0	14.0	12.5	12.5	0.492	12.5	0.492	12.5	0.492	12.5	0.492	12.5	0.492	12.5	0.492	12.5	0.492	12.5	0.492
LC6W1200	24	13.0	14.0	12.5	12.5	0.492	12.5	0.492	12.5	0.492	12.5	0.492	12.5	0.492	12.5	0.492	12.5	0.492	12.5	0.492
LC6W1400	26	13.0	14.0	12.5	12.5	0.492	12.5	0.492	12.5	0.492	12.5	0.492	12.5	0.492	12.5	0.492	12.5	0.492	12.5	0.492
LC6W1600	28	13.0	14.0	12.5	12.5	0.492	12.5	0.492	12.5	0.492	12.5	0.492	12.5	0.492	12.5	0.492	12.5	0.492	12.5	0.492
LC6W1800	30	13.0	14.0	12.5	12.5	0.492	12.5	0.492	12.5	0.492	12.5	0.492	12.5	0.492	12.5	0.492	12.5	0.492	12.5	0.492
LC6W2000	32	13.0	14.0	12.5	12.5	0.492	12.5	0.492	12.5	0.492	12.5	0.492	12.5	0.492	12.5	0.492	12.5	0.492	12.5	0.492

Product Page

- Includes all necessary information for part identification and selection

Agency Listings

Features and Benefits

Full Color Photo and Two-View Drawing

PANDUIT® and Competitor Die Information

Page Reference for PANDUIT® and Competitor Installation Tooling and Die Selection Charts

PANDUIT® TERMINATION SOLUTIONS		Code																		
NEW! PAN-LUG® One-Hole, Long Barrel with Window Lug																				
For Use with Standard Copper Conductors																				
Type: LC6W																				
<ul style="list-style-type: none"> • Insulative window is made of polyethylene material • One-hole design, tested to 7000V, 0.1μF dielectric • Insulative die cast housing for proper clamp die installation • Can be used in metal enclosures 																				
Part Number	Conductor Size (AWG)	Stud Hole Dia (mm)	Window Dia (mm)	Window Dia (in)	Window Dia (mm)	Window Dia (in)	Window Dia (mm)	Window Dia (in)	Window Dia (mm)	Window Dia (in)	Window Dia (mm)	Window Dia (in)	Window Dia (mm)	Window Dia (in)	Window Dia (mm)	Window Dia (in)	Window Dia (mm)	Window Dia (in)		
LC6W0400	14	13.0	14.0	12.5	12.5	0.492	12.5	0.492	12.5	0.492	12.5	0.492	12.5	0.492	12.5	0.492	12.5	0.492	12.5	0.492
LC6W0500	16	13.0	14.0	12.5	12.5	0.492	12.5	0.492	12.5	0.492	12.5	0.492	12.5	0.492	12.5	0.492	12.5	0.492	12.5	0.492
LC6W0600	18	13.0	14.0	12.5	12.5	0.492	12.5	0.492	12.5	0.492	12.5	0.492	12.5	0.492	12.5	0.492	12.5	0.492	12.5	0.492
LC6W0800	20	13.0	14.0	12.5	12.5	0.492	12.5	0.492	12.5	0.492	12.5	0.492	12.5	0.492	12.5	0.492	12.5	0.492	12.5	0.492
LC6W1000	22	13.0	14.0	12.5	12.5	0.492	12.5	0.492	12.5	0.492	12.5	0.492	12.5	0.492	12.5	0.492	12.5	0.492	12.5	0.492
LC6W1200	24	13.0	14.0	12.5	12.5	0.492	12.5	0.492	12.5	0.492	12.5	0.492	12.5	0.492	12.5	0.492	12.5	0.492	12.5	0.492
LC6W1400	26	13.0	14.0	12.5	12.5	0.492	12.5	0.492	12.5	0.492	12.5	0.492	12.5	0.492	12.5	0.492	12.5	0.492	12.5	0.492
LC6W1600	28	13.0	14.0	12.5	12.5	0.492	12.5	0.492	12.5	0.492	12.5	0.492	12.5	0.492	12.5	0.492	12.5	0.492	12.5	0.492
LC6W1800	30	13.0	14.0	12.5	12.5	0.492	12.5	0.492	12.5	0.492	12.5	0.492	12.5	0.492	12.5	0.492	12.5	0.492	12.5	0.492
LC6W2000	32	13.0	14.0	12.5	12.5	0.492	12.5	0.492	12.5	0.492	12.5	0.492	12.5	0.492	12.5	0.492	12.5	0.492	12.5	0.492

Part Number Index

- Found in the last section of the catalog
- Alphanumeric part number listing

Page Reference for PANDUIT® and Competitor Installation Tooling and Die Selection Charts

SYSTEM OVERVIEW

PANDUIT® is a global leader in reliable solutions for terminating, splicing, tapping and disconnecting conductors to meet a variety of electrical applications. *PANDUIT® PAN-TERM®* terminal products include insulated and non-insulated terminals, disconnects, splices and ferrules for terminating wire sizes #22 AWG – #2 AWG. *PANDUIT® PAN-LUG™* products include copper and aluminum compression and mechanical connectors for use with conductor sizes #14 AWG – 1,000 kcmil. All *PANDUIT®* connectors are designed to provide ease of identification, fast termination and optimum conductivity.



- World-class quality — ISO9001 and ISO14001
- High performance and reliability
- Ease of installation and use
- Reduction in total cost of ownership
- Meet the requirements of UL, CSA and NEBS Level 3, as noted



PANDUIT® provides the complete termination system including manual, pneumatic, hydraulic and battery powered hydraulic crimping tools. *PANDUIT®* installation tools are designed with ergonomic features and controlled cycle mechanisms that facilitate ease of operation and ensure reliable, high quality terminations. With a continued focus on the needs of the customer and a high level of investment in research and development, *PANDUIT®* Termination Solutions meet today's needs.

System Overview

Terminals

Disconnects

Splices

Ferrules

Compression Connectors

Crimping Tools

Mechanical Connectors

Grounding Connectors

Support Products

Technical Info

Index

System Overview

GLOBAL SERVICES AND SUPPORTING PROGRAMS

CLIP PROGRAM

Terminals

The Contractor Loyalty Incentive Program (CLIP) was developed to strengthen relationships and form alliances with valued contractors. Use *PANDUIT®* as your preferred vendor for terminals, power connectors, cable ties, identification products, surface raceway, installation tooling and a host of related products, and earn credit towards *PANDUIT®* tooling.

Disconnects

Benefits of being a CLIP participant include annual credit incentives, continuous training, potential project leads, alliance with a global, world-class electrical manufacturer and exclusive promotions.

For more program details, go to www.panduit.com/clip or contact Customer Service at (800) 777-3300.

Splices

TOOLING PARTNERSHIP PROGRAM

The Tooling Partnership Program is designed to make low-cost or no cost tooling available to the customer based on qualification and commitment to termination product purchases.

Ferrules

For more program details, go to www.panduit.com/tpp or contact Customer Service at (800) 777-3300.

PC EXPRESS PROGRAM

Compression Connectors

PC Express offers the ultimate level of service for your power connector needs. PC Express is offered through select authorized *PANDUIT®* distributors. The PC Express Program provides customers with the ability to receive power connector orders, via second day delivery, at no additional charge.

Crimping Tools

The customer can place an order of any size, up to a 300 lb. maximum weight, through an authorized *PANDUIT®* distributor and *PANDUIT®* will absorb the second day freight charges. All orders will be shipped directly to the customer. Orders received by *PANDUIT®* Customer Service before 3:00 P.M. CST will be shipped on the same day, via second day delivery. Orders received after 3:00 P.M. CST will be shipped the next business day, via second day delivery.

Mechanical Connectors

For more program details, go to www.panduit.com/pcexpress or contact Customer Service at (800) 777-3300.

Note: All programs and benefits are subject to terms and conditions.

PANDUIT® CUSTOM COPPER COMPRESSION LUGS

Grounding Connectors

PANDUIT® offers custom lug capabilities to meet your special dimensional specifications and requirements with premium two day or standard two week delivery. *PANDUIT®* provides a wide variety of dimensional choices for #8 AWG to 250 kcmil copper code lugs and #8 AWG to 4/0 AWG copper flex lugs, including the following options:

Support Products

Tongues

- Straight or Bent
- Stacking
- Special Lengths

Technical Info

Stud Holes

- Various Sizes, #10 to 1/2"
- Multiple Hole Sizes and Spacing
- Special Locations

Barrels

- Three Standard Lengths: Short, Standard and Long
- Custom Lengths



Index

For more program details, see [pages F110 - F112](#), go to www.panduit.com/customlugs or contact Customer Service at (800) 777-3300.

PAN-TERM® TERMINALS

PANDUIT® PAN-TERM® Terminals are designed and manufactured for fast assembly, and reliable performance. PANDUIT® provides an extensive line of tooling designed specifically to provide optimum performance. As the demand for loose piece terminals increases, it becomes essential to provide a complete system for termination products.



- Funnel entry available on vinyl and nylon insulated terminals and disconnects, speeds insertion and minimizes turned back wire strands
- Made of electrolytic copper to provide an optimum combination of crimp forming and high conductivity properties to provide optimum terminations
- Offered in various types including rings, forks, flanged forks, locking forks and short locking forks
- Available in sizes from #26 – #2 AWG and stud hole diameters from #2 – 1/2 inch. Non-insulated tubular terminals sizes from #8 – 250 kcmil
- Applicable sizes are UL Listed and CSA Certified, as noted
- Wide assortment of manual, controlled cycle, battery operated hydraulic and pneumatic crimping tools for reliable connections at the lowest installed cost

PANDUIT® continually provides new designs to meet the application challenges encountered by our customers. PANDUIT® offers a wide assortment of PAN-TERM® termination products to meet customer needs at the lowest installed cost.

System
Overview

Terminals

Disconnects

Splices

Ferrules

Compression
Connectors

Crimping
Tools

Mechanical
Connectors

Grounding
Connectors

Support
Products

Technical
Info

Index

System Overview

Features and Benefits — PAN-TERM® Terminals

All PANDUIT® Terminals feature high quality materials made with electrolytic copper for high conductivity and are tin plated for corrosion resistance.

Terminals

Non-Insulated Terminals Type P

Maximum recommended operating temperature 150°C (302°F)

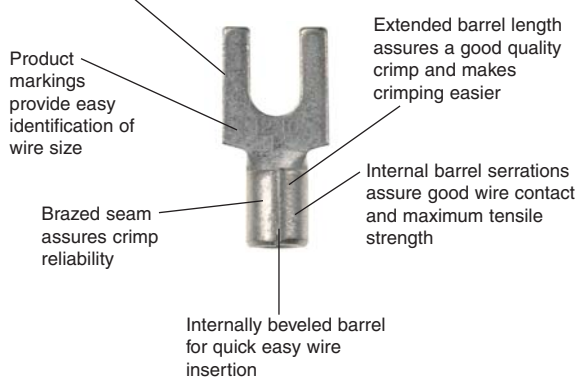

*UL and CSA rated up to 2000V per UL486A.
**Nickel plated terminals rated up to 343°C (650°F) maximum operating temperature.

Nylon Insulated Terminals With Insulation Grip Sleeve Type PN or PNF

Internal barrel serrations assure good wire contact and maximum tensile strength

Insulation grip sleeve provides a superior insulation crimp for high vibration and high strain relief applications

Funnel entry for faster insertion and lower installed cost

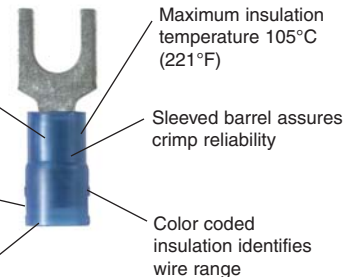

*UL and CSA rated up to 600V per UL486.
** Flammability – UL94V-2/HB*.
***Proprietary blend of UL94V-2 and UL94HB flammability rated materials.

Disconnects

Splices

Ferrules

Compression Connectors

Crimping Tools

Mechanical Connectors

Grounding Connectors

Support Products

Technical Info

Index

Vinyl Insulated Terminals With Insulation Support Type PV

Internal barrel serrations assure good wire contact and maximum tensile strength

Insulation crimp provides insulation support to protect electrical crimp

Funnel entry for faster insertion and lower installed cost

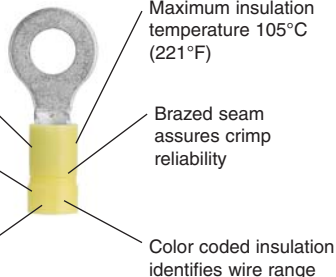

*UL and CSA rated up to 600V per UL486.
**Flammability – UL94V-0.

Non-Insulated Seamless Tubular Terminals Type S

Internally beveled barrel for quick easy wire insertion

Seamless tubular barrel provides consistent, high performance, quality crimps

Maximum recommended operating temperature 150°C (302°F)

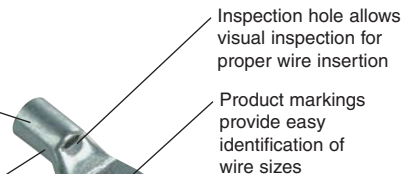

*UL and CSA rated up to 2000V per UL486A.

Selection Guide — PAN-TERM® Ring Terminals

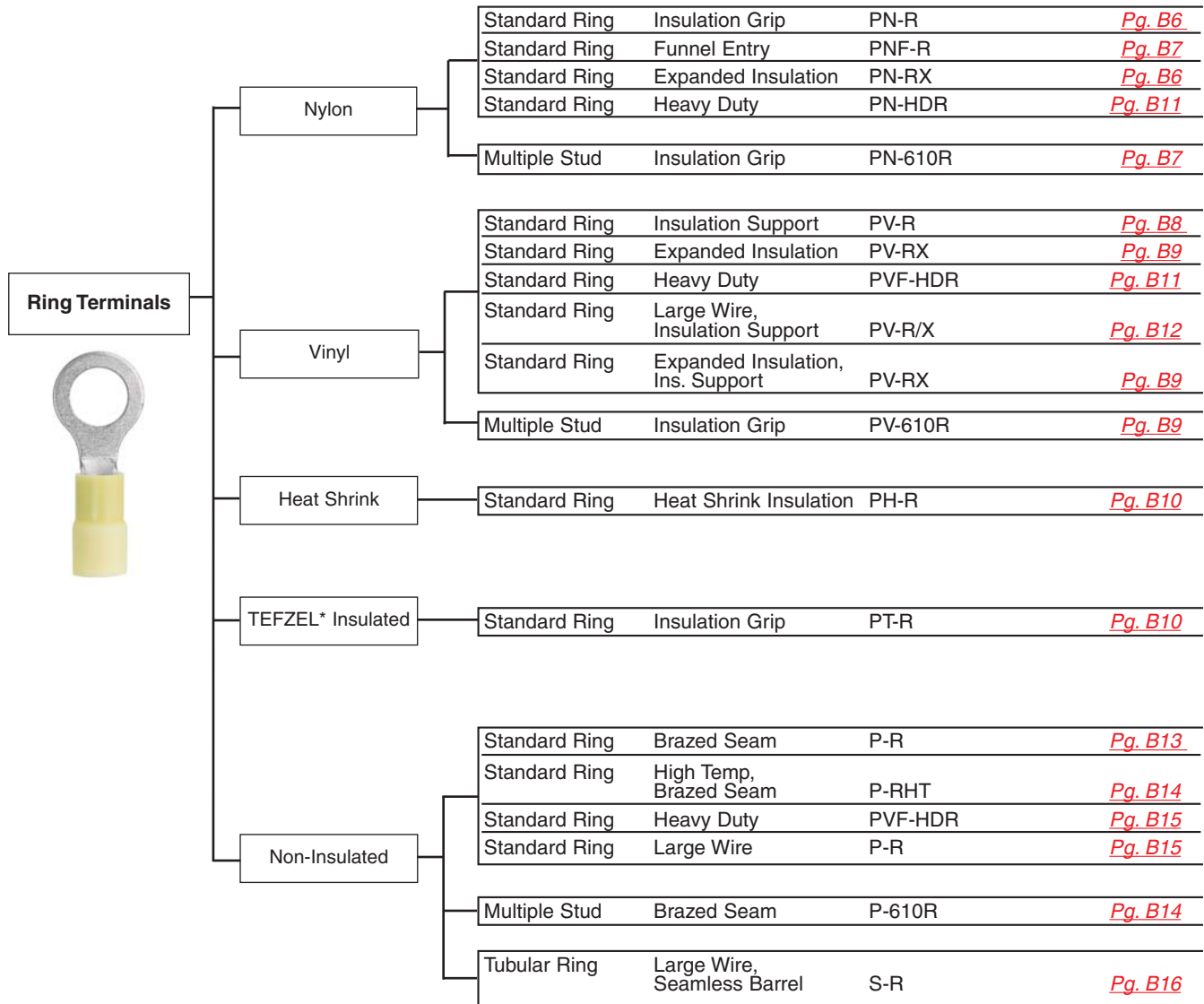

*TEFZEL is a registered trademark of E.I. DuPont De Nemours Co.

System Overview

Terminals

Disconnects

Splices

Ferrules

Compression Connectors

Crimping Tools

Mechanical Connectors

Grounding Connectors

Support Products

Technical Info

Index

System Overview

Selection Guide — PAN-TERM® Fork Terminals

Terminals

Disconnects

Splices

Ferrules

Compression Connectors

Crimping Tools

Mechanical Connectors

Grounding Connectors

Support Products

Technical Info

Index

Fork Terminals					
	Nylon	Standard Fork	Insulation Grip	PN-F	Pg. B17
		Standard Fork	Funnel Entry	PNF-F	Pg. B17
		Locking Fork	Insulation Grip	PN-LF	Pg. B19
		Locking Fork	Funnel Entry	PNF-LF	Pg. B19
		Locking Fork, Short	Insulation Grip	PN-SLF	Pg. B21
		Locking Fork, Short	Funnel Entry	PNF-SLF	Pg. B21
		Flanged Fork	Insulation Grip	PN-FF	Pg. B22
		Standard Fork	Insulation Support	PV-F	Pg. B18
		Standard Fork	Expanded Insulation	PV-FX	Pg. B18
		Locking Fork	Funnel Entry	PV-LF	Pg. B20
	Vinyl	Locking Fork	Expanded Insulation Ins. Support	PV-LFX	Pg. B20
		Locking Fork, Short	Funnel Entry	PV-SLF	Pg. B22
		Flanged Fork	Funnel Entry	PV-FF	Pg. B22
		Heat Shrink	Standard Fork	Heat Shrink Insulation	PH-F
Non-Insulated	Standard Fork	Brazed Seam	P-F	Pg. B23	
	Flanged Fork	Brazed Seam	P-FF	Pg. B23	
	Locking Fork	Brazed Seam	PLF	Pg. B24	
	Locking Fork, Short	Brazed Seam	P-SLF	Pg. B24	

Performance Requirements

	Wire Size (AWG)								
	#26	#24	#22	#20	#18	#16	#14	#12	#10
UL 486A (TERMINALS), UL310 (MALE BLADE ADAPTERS)									
Test Current for Max. 50°C Rise (Amps)	3.5	7	9	12	17	18	30	35	50
Min. Tensile Strength* (Lbs.)	3	5	8	13	20	30	50	70	80
UL 486C (SPLICES)									
Test Current for Max. 50°C Rise (Amps)	5.5	7	9	12	17	18	30	35	50
Min. Tensile Strength* (Lbs.)	3	5	8	10	10	15	25	35	40

*Pull-out force of the crimped terminal.

Applicable **PAN-TERM®** products meet or exceed the following test specifications:

- UL486A (Terminals)
- UL486C (Splices)
- UL310 (Blade Adapters)
- CSA C22.2 No. 65 (all designs)

UL and CSA approved products are shown with the applicable logos in the product section.

UL file #E52164, CSA File #LR31212.

Part Number System for **PAN-TERM®** Terminals

P	N	14	—	4	R	X	—	C
┌ └					┌ └			
Type	Insulation	Wire Range		Stud Size	Tongue Configuration	Special Configuration		Std. Pkg. Size
P = <i>PAN-TERM®</i> Seamed Barrel	T = TEFZEL* Insulated	22 = #26-22 18 = #22-18		2 = #2 4 = #4	HDR = Heavy Duty Ring	HT6 = High Temperature		5 = 5
S = <i>PAN-TERM®</i> Seamless Tubular Barrel	N = Nylon Insulated	14 = #16-14 12 = #16-12		5 = #5 6 = #6	F = Fork	N = Narrow Tongue		X = 10
	NF = Nylon Insulated Funnel Entry	10 = #12-10 8 = #8 6 = #6		8 = #8 10 = #10 14 = 1/4"	FF = Flanged Fork	W = Wide Tongue		E = 20
	V = Vinyl Insulated	4 = #4 2 = #2		56 = 5/16" 38 = 3/8"	LF = Locking Fork	X = Expanded Insulation		Q = 25
	= Non-Ins. (leave blank)	1 = #1 1/0 = 1/0 2/0 = 2/0 3/0 = 3/0 4/0 = 4/0 250 = 250kcmil		76 = 7/16" 12 = 1/2"	P = Pin R = Ring SLF = Short Locking Fork	= Non- Expanded Insulation (leave blank)		L = 50
								C = 100
								T = 200
								D = 500
								M = 1000

System
Overview

Terminals

Disconnects

Splices

Ferrules

Compression
Connectors

Crimping
Tools

Mechanical
Connectors

Grounding
Connectors

Support
Products

Technical
Info

Index

System Overview



Ring Terminal, Nylon Insulated

Type PN-R

- Insulation grip sleeve

Terminals



Disconnects

Splices

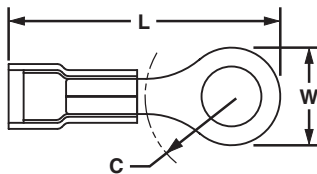

Ferrules

Compression Connectors

Crimping Tools

Mechanical Connectors

Part Number	Wire Range	Color Code	Stock Thickness	Max. Ins.	Stud Size	Figure Dimensions (In.)			Crimp Tool	Std. Pkg. Qty.**	Std. Ctn. Qty.
						L	W	C			
PN22-2R-C*	26-22 AWG	Yellow	.02	.090	#2	.69	.20	.18	CT-100, CT-600, CT-1525	100	1000
PN22-4R-C*			.02	.090	#4	.69	.20	.18		100	1000
PN22-6R-C*			.02	.090	#6	.69	.20	.18		100	1000
PN22-8R-C*			.02	.090	#8	.78	.26	.26		100	1000
PN22-10R-C*			.02	.090	#10	.78	.31	.24		100	1000
PN18-4RN-C	22-18 AWG	Red	.03	.145	#4	.74	.22	.18	CT-100‡, CT-600‡, CT-1550‡, CT-1551‡	100	500
PN18-4R-C			.03	.145	#4	.80	.25	.22		100	500
PN18-6RN-C			.03	.145	#6	.77	.22	.18		100	500
PN18-6R-C			.03	.145	#6	.80	.25	.22		100	500
PN18-8R-C			.03	.145	#8	.86	.31	.25		100	500
PN18-10R-C			.03	.145	#10	.88	.31	.25		100	500
PN18-14R-C			.03	.145	1/4"	1.09	.45	.38		100	500
PN18-56R-C			.03	.145	5/16"	1.09	.46	.38		100	500
PN18-38R-C			.03	.145	3/8"	1.17	.53	.43		100	500
PN18-12R-C			.03	.145	1/2"	1.35	.72	.53		100	500
PN14-4R-C	16-14 AWG	Blue	.03	.162	#4	.78	.25	.20	CT-100‡, CT-600‡, CT-1550‡, CT-1551‡	100	500
PN14-6RN-C			.03	.162	#6	.76	.25	.20		100	500
PN14-6R-C			.03	.162	#6	.85	.31	.25		100	500
PN14-8R-C			.03	.162	#8	.85	.31	.25		100	500
PN14-10R-C			.03	.162	#10	.85	.31	.25		100	500
PN14-14R-C			.03	.162	1/4"	1.05	.46	.38		100	500
PN14-56R-C			.03	.162	5/16"	1.05	.46	.38		100	500
PN14-38R-L			.03	.162	3/8"	1.14	.53	.43		50	500
PN14-12R-L			.03	.162	1/2"	1.35	.72	.53		50	500
PN10-6R-L			12-10 AWG	Yellow	.04	.225	#6	1.08		.37	.31
PN10-8R-L	.04	.225			#8	1.08	.37	.31	50	500	
PN10-10R-L	.04	.225			#10	1.08	.38	.31	50	500	
PN10-14R-L	.04	.225			1/4"	1.23	.52	.38	50	500	
PN10-56R-L	.04	.225			5/16"	1.23	.52	.38	50	500	
PN10-38R-L	.04	.225			3/8"	1.31	.58	.43	50	500	
PN10-12R-L	.04	.225			1/2"	1.47	.72	.53	50	500	

*Wire sizes #26-22 AWG, are not UL Listed or CSA Certified.

**To order in bulk, replace -C in the part number with -M for a bulk package of 1000 and replace -L with -D for a bulk package of 500.

‡UL and CSA approved tooling/product combinations.

Grounding Connectors



Ring Terminal, Nylon Insulated – Expanded Insulation

Type PN-RX

- Insulation grip sleeve
- For large wire insulation O.D.

Support Products



Technical Info

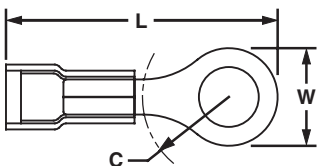

Index

Part Number	Wire Range	Color Code	Stock Thickness	Max. Ins.	Stud Size	Figure Dimensions (In.)			Crimp Tool	Std. Pkg. Qty.**	Std. Ctn. Qty.
						L	W	C			
PN14-6RX-C	16-14 AWG	Blue	.03	.200	#6	.93	.31	.25	CT-100‡, CT-600‡, CT-1550‡, CT-1551‡	100	500
PN14-8RX-C			.03	.200	#8	.93	.31	.25		100	500
PN14-10RX-C			.03	.200	#10	.93	.31	.25		100	500
PN14-14RX-C	12-10 AWG	Yellow	.03	.200	1/4"	1.13	.46	.38	CT-100‡, CT-600‡, CT-1550‡, CT-1551‡	100	500
PN10-6RX-L			.04	.265	#6	1.13	.37	.33		50	500
PN10-8RX-L			.04	.265	#8	1.13	.37	.33		50	500
PN10-10RX-L			.04	.265	#10	1.13	.37	.33		50	500
PN10-14RX-L			.04	.265	1/4"	1.27	.52	.42		50	500
PN10-56RX-L			.04	.265	5/16"	1.27	.52	.42		50	500
PN10-38RX-L			.04	.265	3/8"	1.35	.58	.46		50	500

**To order in bulk, replace -C in the part number with -M for a bulk package of 1000 and replace -L with -D for a bulk package of 500.

‡UL and CSA approved tooling/product combinations.



Ring Terminal, Nylon Insulated – Funnel Entry

Type PNF-R

- Insulation grip sleeve

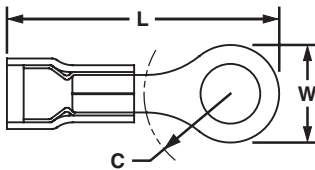

Part Number	Wire Range	Color Code	Stock Thickness	Max. Ins.	Stud Size	Figure Dimensions (In.)			Crimp Tool	Std. Pkg. Qty.**	Std. Ctn. Qty.			
						L	W	C						
PNF18-4R-C	22-18 AWG	Red	.03	.136	#4	.77	.25	.20	CT-100‡, CT-600‡, CT-1550‡, CT-1551‡	100	500			
PNF18-6RN-C			.03	.136	#6	.76	.22	.18		100	500			
PNF18-6R-C			.03	.136	#6	.77	.25	.20		100	500			
PNF18-8R-C			.03	.136	#8	.87	.31	.24		100	500			
PNF18-10R-C			.03	.136	#10	.87	.32	.25		100	500			
PNF18-14R-C			.03	.136	1/4"	1.08	.46	.38		100	500			
PNF18-56R-C			.03	.136	5/16"	1.08	.46	.39		100	500			
PNF18-38R-C			.03	.136	3/8"	1.16	.53	.41		100	500			
PNF14-4R-C			16-14 AWG	Blue	.03	.162	#4	.78		.25	.18	CT-100‡, CT-600‡, CT-1550‡, CT-1551‡	100	500
PNF14-6RN-C					.03	.162	#6	.78		.25	.18		100	500
PNF14-6R-C	.03	.162			#6	.87	.31	.24	100	500				
PNF14-8R-C	.03	.162			#8	.87	.31	.25	100	500				
PNF14-10R-C	.03	.162			#10	.85	.31	.29	100	500				
PNF14-14R-C	.03	.162			1/4"	1.06	.46	.40	100	500				
PNF14-56R-C	.03	.162			5/16"	1.06	.46	.40	100	500				
PNF14-38R-L	.03	.162			3/8"	1.14	.53	.45	50	500				
PNF10-6R-L	12-10 AWG	Yellow			.04	.225	#6	1.12	.37	.31	CT-100‡, CT-600‡, CT-1550‡, CT-1551‡		50	500
PNF10-8R-L					.04	.225	#8	1.12	.37	.31			50	500
PNF10-10R-L			.04	.225	#10	1.10	.37	.31	50	500				
PNF10-14R-L			.04	.225	1/4"	1.25	.52	.38	50	500				
PNF10-56R-L			.04	.225	5/16"	1.21	.52	.38	50	500				
PNF10-38R-L			.04	.225	3/8"	1.35	.58	.43	50	500				

**To order in bulk, replace -C in the part number with -M for a bulk package of 1000 and replace -L with -D for a bulk package of 500.

‡UL and CSA approved tooling/product combinations.



Multiple Stud Terminal, Nylon Insulated

Type PN-610R

- Insulation grip sleeve
- Single terminal for #6, #8 and #10 size studs

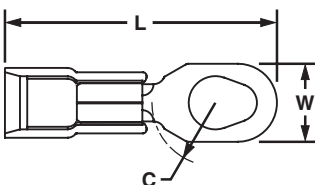

Part Number	Wire Range	Color Code	Stock Thickness	Max. Ins.	Stud Size	Figure Dimensions (In.)			Crimp Tool	Std. Pkg. Qty.**	Std. Ctn. Qty.
						L	W	C			
PN18-610R-C	22-18 AWG	Red	.03	.145	#6, #8, #10	.95	.31	.25	CT-100‡, CT-600‡, CT-1550‡, CT-1551‡	100	500
PN14-610R-C	16-14 AWG	Blue	.03	.162		.95	.31	.25		100	500
PN10-610R-L	12-10 AWG	Yellow	.04	.225		1.15	.37	.31		50	500

**To order in bulk, replace -C in the part number with -M for a bulk package of 1000 and replace -L with -D for a bulk package of 500.

‡UL and CSA approved tooling/product combinations.

System Overview

Terminals

Disconnects

Splices

Ferrules

Compression Connectors

Crimping Tools

Mechanical Connectors

Grounding Connectors

Support Products

Technical Info

Index

System Overview



Ring Terminal, Vinyl Insulated – Funnel Entry

Type PV-R

- Insulation support
- Brazed seam

Terminals



Disconnects

Splices

Ferrules

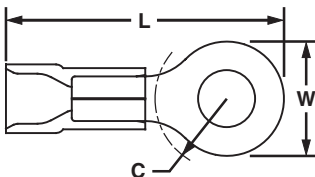

Compression Connectors

Crimping Tools

Mechanical Connectors

Grounding Connectors

Support Products

Technical Info

Index

Part Number	Wire Range	Color Code	Stock Thickness	Max. Ins.	Stud Size	Figure Dimensions (In.)			Crimp Tool	Std. Pkg. Qty.**	Std. Ctn. Qty.
						L	W	C			
PV22-2R-C*	26-22 AWG	Yellow	.02	.110	#2	.68	.21	.18	CT-100, CT-600, CT-1525	100	1000
PV22-4R-C*			.02	.110	#4	.68	.21	.18		100	1000
PV22-6R-C*			.02	.110	#6	.68	.21	.18		100	1000
PV22-8R-C*			.02	.110	#8	.78	.26	.26		100	1000
PV22-10R-C*	22-18 AWG	Red	.02	.110	#10	.78	.32	.24	CT-100‡, CT-600‡, CT-1550‡, CT-1551‡	100	1000
PV18-4R-C			.03	.150	#4	.84	.25	.22		100	500
PV18-6R-C			.03	.150	#6	.86	.25	.22		100	500
PV18-8R-C			.03	.150	#8	.91	.31	.26		100	500
PV18-10R-C			.03	.150	#10	.94	.31	.27		100	500
PV18-14R-C			.03	.150	1/4"	1.11	.46	.37		100	500
PV18-56R-C			.03	.150	5/16"	1.11	.46	.39		100	500
PV18-38R-C			.03	.150	3/8"	1.19	.53	.42		100	500
PV18-12R-C			.03	.150	1/2"	1.42	.72	.53		100	500
PV14-4R-C			16-14 AWG	Blue	.03	.170	#4	.84		.25	.19
PV14-6RN-C	.03	.170			#6	.84	.25	.19	100	500	
PV14-6R-C	.03	.170			#6	.92	.31	.25	100	500	
PV14-8R-C	.03	.170			#8	.92	.31	.25	100	500	
PV14-10R-C	.03	.170			#10	.92	.31	.25	100	500	
PV14-14R-C	.03	.170			1/4"	1.12	.46	.38	100	500	
PV14-56R-C	.03	.170			5/16"	1.12	.46	.38	100	500	
PV14-38R-L	.03	.170			3/8"	1.21	.53	.43	50	500	
PV14-12R-L	.03	.170			1/2"	1.42	.72	.53	50	500	
PV10-6R-L	12-10 AWG	Yellow			.04	.225	#6	1.05	.31	.31	CT-100‡, CT-600‡, CT-1550‡, CT-1551‡
PV10-8R-L			.04	.225	#8	1.05	.31	.31	50	500	
PV10-10R-L			.04	.225	#10	1.05	.31	.31	50	500	
PV10-14R-L			.04	.225	1/4"	1.23	.52	.38	50	500	
PV10-56R-L			.04	.225	5/16"	1.23	.52	.38	50	500	
PV10-38R-L			.04	.225	3/8"	1.31	.58	.41	50	500	
PV10-12R-L			.04	.225	1/2"	1.46	.72	.53	50	500	

*Wire sizes #26-22 AWG, are not UL Listed or CSA Certified.

**To order in bulk, replace -C in the part number with -M for a bulk package of 1000 and replace -L with -D for a bulk package of 500.

‡UL and CSA approved tooling/product combinations.



Ring Terminal, Vinyl Expanded Insulation

Type PV-RX

- Insulation support
- Brazed seam
- For large wire insulation O.D.

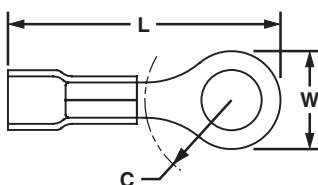

Part Number	Wire Range	Color Code	Stock Thickness	Max. Ins.	Stud Size	Figure Dimensions (In.)			Crimp Tool	Std. Pkg. Qty.**	Std. Ctn. Qty.
						L	W	C			
PV18-4RX-C	22-18 AWG	Red	.03	.170	#4	.88	.25	.22	CT-100‡, CT-600‡, CT-1550‡, CT-1551‡	100	500
PV18-6RX-C			.03	.170	#6	.89	.25	.22		100	500
PV18-8RX-C			.03	.170	#8	.97	.31	.27		100	500
PV18-10RX-C			.03	.170	#10	.96	.31	.27		100	500
PV18-14RX-C			.03	.170	1/4"	1.17	.46	.40		100	500
PV18-56RX-C			.03	.170	5/16"	1.17	.46	.40		100	500
PV18-38RX-C			.03	.170	3/8"	1.25	.53	.45		100	500
PV14-4RX-C	16-14 AWG	Blue	.03	.200	#4	.87	.25	.19	CT-100‡, CT-600‡, CT-1550‡, CT-1551‡	100	500
PV14-6RX-C			.03	.200	#6	.96	.31	.25		100	500
PV14-8RX-C			.03	.200	#8	.96	.31	.25		100	500
PV14-10RX-C			.03	.200	#10	.96	.31	.25		100	500
PV14-14RX-C			.03	.200	1/4"	1.16	.46	.37		100	500
PV14-56RX-C			.03	.200	5/16"	1.16	.46	.37		100	500
PV14-38RX-L			.03	.200	3/8"	1.25	.53	.42		50	500
PV10-6RX-L	12-10 AWG	Yellow	.04	.250	#6	1.10	.31	.30	CT-100‡, CT-600‡, CT-1550‡, CT-1551‡	50	500
PV10-8RX-L			.04	.250	#8	1.10	.31	.30		50	500
PV10-10RX-L			.04	.250	#10	1.10	.31	.30		50	500
PV10-14RX-L			.04	.250	1/4"	1.29	.52	.39		50	500
PV10-56RX-L			.04	.250	5/16"	1.29	.52	.42		50	500
PV10-38RX-L			.04	.250	3/8"	1.39	.58	.46		50	500

**To order in bulk, replace -C in the part number with -M for a bulk package of 1000 and replace -L with -D for a bulk package of 500.

‡UL and CSA approved tooling/product combinations.



Multiple Stud Terminal, Vinyl Insulated – Funnel Entry

Type PV-610R

- Insulation support
- Brazed seam

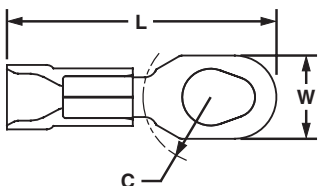

Part Number	Wire Range	Color Code	Stock Thickness	Max. Ins.	Stud Size	Figure Dimensions (In.)			Crimp Tool	Std. Pkg. Qty.**	Std. Ctn. Qty.
						L	W	C			
PV18-610R-C	22-18 AWG	Red	.03	.150	#6, #8, #10	1.00	.31	.25	CT-100, CT-600‡, CT-1550‡, CT-1551‡	100	500
PV14-610R-C	16-14 AWG	Blue	.03	.170		1.00	.31	.25		100	500
PV10-610R-L	12-10 AWG	Yellow	.04	.225		1.17	.37	.31		50	500

**To order in bulk, replace -C in the part number with -M for a bulk package of 1000 and replace -L with -D for a bulk package of 500.

‡UL and CSA approved tooling/product combinations.

System Overview

Terminals

Disconnects

Splices

Ferrules

Compression Connectors

Crimping Tools

Mechanical Connectors

Grounding Connectors

Support Products

Technical Info

Index

System Overview



Ring Terminal TEFZEL* Insulated

Type PT-R

- Insulation grip sleeve
- Butted seam with metal sleeve
- For nuclear containment areas and high temperature (to 150°C) applications
- Color code: white with appropriate color stripe

Terminals



Disconnects

Splices

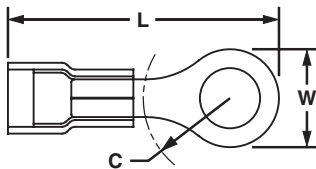

Ferrules

Part Number	Wire Range	Color Code	Stock Thickness	Max. Ins.	Stud Size	Figure Dimensions (In.)			Crimp Tool	Std. Pkg. Qty.	Std. Ctn. Qty.
						L	W	C			
PT18-4R-C	22-18 AWG	Red Stripe	.03	.145	#4	.75	.25	.22	CT-100, CT-600‡, CT-1550‡, CT-1551‡	100	500
PT18-6R-C			.03	.145	#6	.78	.25	.22		100	500
PT18-8R-C			.03	.145	#8	.84	.31	.29		100	500
PT18-10R-C			.03	.145	#10	.84	.31	.29		100	500
PT18-14R-C	16-14 AWG	Blue Stripe	.03	.145	1/4"	1.05	.46	.40	CT-100, CT-600‡, CT-1550‡, CT-1551‡	100	500
PT14-4R-C			.03	.162	#4	.75	.25	.22		100	500
PT14-6R-C			.03	.162	#6	.84	.31	.29		100	500
PT14-8R-C			.03	.162	#8	.84	.31	.29		100	500
PT14-10R-C	12-10 AWG	Yellow Stripe	.03	.162	#10	.84	.31	.29	CT-100, CT-600‡, CT-1550‡, CT-1551‡	100	500
PT14-14R-C			.03	.162	1/4"	1.05	.46	.40		100	500
PT10-6R-L			.04	.225	#6	1.03	.37	.33		50	500
PT10-8R-L			.04	.225	#8	1.03	.37	.33		50	500
PT10-10R-L	12-10 AWG	Yellow Stripe	.04	.225	#10	1.03	.37	.33	CT-100, CT-600‡, CT-1550‡, CT-1551‡	50	500
PT10-14R-L			.04	.225	1/4"	1.18	.52	.42		50	500

*TEFZEL is a registered trademark of E.I. Du Pont De Nemours and Company.

‡UL approved tooling/product combinations.

Compression Connectors



Heat Shrink, Ring Terminal

Type PH-R

- Heat shrink polyolefin with hot melt sealant
- Minimum shrink temperature 300°F (150°C)
- Brazed seam
- Adhesive lined heat shrink
- Heat shrink insulated terminals are both air and water tight

Crimping Tools



Mechanical Connectors

Grounding Connectors

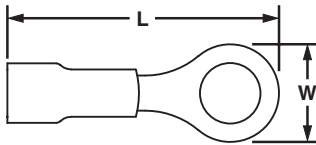

Support Products

Part Number	Wire Range	Color Code	Max. Ins.	Stud Size	Figure Dimensions (In.)		Wire Strip Length	Crimp Tool	Std. Pkg. Qty.	Std. Ctn. Qty.
					L	W				
PH18-6R-Q	22-18 AWG	Red	.170	#6	1.05	.25	5/16	CT-310	25	125
PH18-8R-Q			.170	#8	1.08	.31	5/16		25	125
PH18-10R-Q			.170	#10	1.08	.31	5/16		25	125
PH18-14R-Q			.170	1/4"	1.30	.47	5/16		25	125
PH14-6R-Q	16-14 AWG	Blue	.190	#6	1.06	.31	5/16	CT-310	25	125
PH14-8R-Q			.190	#8	1.03	.31	5/16		25	125
PH14-10R-Q			.190	#10	1.12	.31	5/16		25	125
PH14-14R-Q			.190	1/4"	1.24	.46	5/16		25	125
PH14-56R-Q	12-10 AWG	Yellow	.190	5/16"	1.27	.46	5/16	CT-310	25	125
PH14-38R-Q			.190	3/8"	1.26	.53	5/16		25	125
PH10-8R-E			.240	#8	1.22	.37	5/16		20	100
PH10-10R-E			.240	#10	1.20	.37	5/16		20	100
PH10-14R-E	12-10 AWG	Yellow	.240	1/4"	1.41	.52	5/16	CT-310	20	100
PH10-38R-E			.240	3/8"	1.45	.59	5/16		20	100
PH10-12R-E			.240	1/2"	1.54	.72	5/16		20	100

Technical Info

Index



Ring Terminal, Heavy Duty, Nylon Insulated

Type PN-HDR

- Insulation grip sleeve
- Manufactured from stock 56% thicker than a standard #16-14 AWG terminal

- Designed for use in demanding applications such as industrial equipment and electric utilities
- Expanded insulation for large wire insulation O.D.

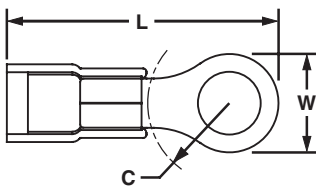

Part Number	Wire Range	Color Code	Stock Thickness	Max. Ins.	Stud Size	Figure Dimensions (In.)			Crimp Tool	Std. Pkg. Qty.**	Std. Ctn. Qty.
						L	W	C			
PN12-8HDR-L	16-12 AWG	Yellow	.05	.225	#8	1.06	.31	.35	CT-1550‡, CT-1551‡	50	500
PN12-10HDR-L			.05	.225	#10	1.09	.37	.33		50	500
PN12-14HDR-L			.05	.225	1/4"	1.24	.52	.42		50	500
PN12-56HDR-L			.05	.225	5/16"	1.24	.52	.42		50	500
PN12-38HDR-L			.05	.225	3/8"	1.30	.58	.46		50	500

**To order in bulk, replace -L with -D for a bulk package of 500.

‡UL and CSA approved tooling/product combinations.



Ring Terminal, Heavy Duty, Vinyl Insulated – Funnel Entry

Type PV-HDR

- Insulation support
- Brazed seam

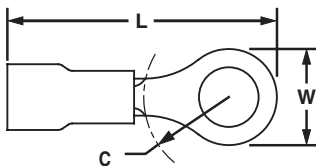

Part Number	Wire Range	Color Code	Stock Thickness	Max. Ins.	Stud Size	Figure Dimensions (In.)			Crimp Tool	Std. Pkg. Qty.**	Std. Ctn. Qty.
						L	W	C			
PV12-6HDR-L	16-12 AWG	Yellow	.05	.225	#6	1.05	.31	.35	CT-600‡, CT-1550‡, CT-1551‡	50	500
PV12-8HDR-L			.05	.225	#8	1.05	.31	.35		50	500
PV12-10HDR-L			.05	.225	#10	1.08	.37	.33		50	500
PV12-14HDR-L			.05	.225	1/4"	1.23	.52	.42		50	500
PV12-56HDR-L			.05	.225	5/16"	1.23	.52	.42		50	500
PV12-38HDR-L			.05	.225	3/8"	1.31	.58	.46		50	500

Expanded Insulation

PV12-6HDRX-L	16-12 AWG	Yellow	.05	.250	#6	1.08	.31	.33	CT-600‡, CT-1550‡, CT-1551‡	50	500
PV12-8HDRX-L			.05	.250	#8	1.08	.31	.33		50	500
PV12-10HDRX-L			.05	.250	#10	1.15	.37	.31		50	500
PV12-14HDRX-L			.05	.250	1/4"	1.30	.52	.40		50	500
PV12-56HDRX-L			.05	.250	5/16"	1.30	.52	.40		50	500
PV12-38HDRX-L			.05	.250	3/8"	1.38	.58	.44		50	500

**To order in bulk, replace -L with -D for a bulk package of 500.

‡UL and CSA approved tooling/product combinations.

System Overview

Terminals

Disconnects

Splices

Ferrules

Compression Connectors

Crimping Tools

Mechanical Connectors

Grounding Connectors

Support Products

Technical Info

Index

System Overview



Ring Terminal, Large Wire, Vinyl Insulated

Type PV-R

- Insulation support
- #8 through #2 AWG wire sizes, accommodates heavy duty construction for demanding applications
- Brazed seam

Terminals

Disconnects



Splices



Ferrules

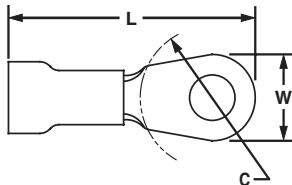

Compression Connectors

Part Number	Wire Range	Color Code	Stock Thickness	Max. Ins.	Stud Size	Figure Dimensions (In.)			Crimp Tool	Std. Pkg. Qty.**	Std. Ctn. Qty.
						L	W	C			
PV8-8R-Q	8 AWG	Red	.04	.280	#8	1.51	.42	.43	CT-720, CD-720PV8-2‡	25	250
PV8-10R-Q			.04	.280	#10	1.53	.47	.43			
PV8-14R-Q			.04	.280	1/4"	1.53	.47	.43			
PV8-56R-Q			.04	.280	5/16"	1.64	.59	.49			
PV8-38R-Q			.04	.280	3/8"	1.64	.59	.51			
PV8-12R-Q			.04	.280	1/2"	1.74	.82	.54			
PV6-8R-E	6 AWG	Blue	.05	.340	#8	1.61	.47	.43	CT-720, CD-720PV8-2‡	20	200
PV6-10R-E			.05	.340	#10	1.62	.47	.43			
PV6-14R-E			.05	.340	1/4"	1.65	.47	.48			
PV6-56R-E			.05	.340	5/16"	1.74	.62	.53			
PV6-38R-E			.05	.340	3/8"	1.74	.62	.51			
PV6-12R-E			.05	.340	1/2"	1.84	.82	.51			
PV4-10R-E	4 AWG	Yellow	.05	.450	#10	1.88	.55	.50	CT-720, CD-720PV8-2‡	20	200
PV4-14R-E			.05	.450	1/4"	1.88	.55	.50			
PV4-56R-E			.05	.450	5/16"	1.95	.68	.50			
PV4-38R-E			.05	.450	3/8"	1.95	.68	.50			
PV2-10R-X	2 AWG	Red	.06	.560	#10	1.96	.68	.58	CT-720, CD-720PV8-2‡	10	100
PV2-14R-X			.06	.560	1/4"	1.96	.68	.58			
PV2-56R-X			.06	.560	5/16"	1.96	.68	.58			
PV2-38R-X			.06	.560	3/8"	1.96	.68	.58			
PV2-12R-X			.06	.560	1/2"	2.05	.86	.58			

**To order in bulk, replace -Q, -E, or -X in the part number with -T for a bulk package of 200.
‡UL approved tooling/product combinations.

Crimping Tools



Ring Terminal, Large Wire, Vinyl Expanded Insulation

Type PV-RX

- Insulation support
- Brazed seam
- For large wire insulation O.D.

Mechanical Connectors



Grounding Connectors



Support Products



Technical Info

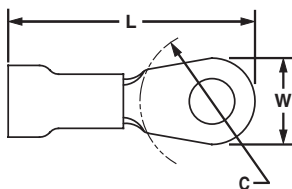

Part Number	Wire Range	Color Code	Stock Thickness	Max. Ins.	Stud Size	Figure Dimensions (In.)			Crimp Tool	Std. Pkg. Qty.**	Std. Ctn. Qty.
						L	W	C			
PV8-8RX-Q	8 AWG	Red	.04	.360	#8	1.50	.42	.43	CT-720, CD-720PV8-2‡	25	250
PV8-10RX-Q			.04	.360	#10	1.52	.47	.43			
PV8-14RX-Q			.04	.360	1/4"	1.52	.47	.43			
PV8-56RX-Q			.04	.360	5/16"	1.62	.59	.51			
PV8-38RX-Q			.04	.360	3/8"	1.62	.59	.51			
PV8-12RX-Q			.04	.360	1/2"	1.74	.82	.51			
PV6-8RX-E	6 AWG	Blue	.05	.436	#8	1.61	.47	.43	CT-720, CD-720PV8-2‡	20	200
PV6-10RX-E			.05	.436	#10	1.61	.47	.43			
PV6-14RX-E			.05	.436	1/4"	1.61	.47	.43			
PV6-56RX-E			.05	.436	5/16"	1.73	.62	.51			
PV6-38RX-E			.05	.436	3/8"	1.73	.62	.53			
PV6-12RX-E			.05	.436	1/2"	1.83	.82	.53			
PV4-10RX-E	4 AWG	Yellow	.05	.515	#10	1.87	.55	.53	CT-720, CD-720PV8-2‡	20	200
PV4-14RX-E			.05	.515	1/4"	1.87	.55	.53			
PV4-56RX-E			.05	.515	5/16"	1.94	.68	.53			
PV4-38RX-E			.05	.515	3/8"	1.94	.68	.53			
PV4-12RX-E	.05	.515	1/2"	2.03	.86	.53					
PV2-10RX-X	2 AWG	Red	.06	.610	#10	1.95	.68	.57	CT-720, CD-720PV8-2‡	10	100
PV2-14RX-X			.06	.610	1/4"	1.93	.68	.57			
PV2-56RX-X			.06	.610	5/16"	1.93	.68	.57			
PV2-38RX-X			.06	.610	3/8"	1.94	.69	.57			
PV2-12RX-X			.06	.610	1/2"	2.20	.86	.57			

**To order in bulk, replace -Q, -E, or -X in the part number with -T for a bulk package of 200.
‡UL approved tooling/product combinations.



Ring Terminal, Non-Insulated

Type P-R

- Brazed seam
- Beveled wire lead-in

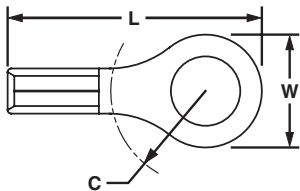

Part Number	Wire Range	Stock Thickness	Stud Size	Figure Dimensions (In.)			Crimp Tool	Std. Pkg. Qty.**	Std. Ctn. Qty.
				L	W	C			
P22-2R-C*	26-22 AWG	.02	#2	.52	.20	.16	CT-100, CT-200	100	1000
P22-4R-C*		.02	#4	.52	.20	.16		100	1000
P22-6R-C*		.02	#6	.52	.20	.16		100	1000
P22-8R-C*		.02	#8	.63	.26	.25		100	1000
P22-10R-C*		.02	#10	.63	.31	.22		100	1000
P18-4R-C	22-18 AWG	.03	#4	.62	.25	.21	CT-100‡, CT-200‡, CT-600‡, CT-1570‡	100	1000
P18-6RN-C		.03	#6	.62	.22	.19		100	1000
P18-6R-C		.03	#6	.62	.25	.21		100	1000
P18-8R-C		.03	#8	.71	.31	.25		100	1000
P18-10R-C		.03	#10	.71	.31	.25		100	1000
P18-12R-C		.03	1/2"	1.20	.72	.53		100	1000
P18-14R-C		.03	1/4"	.91	.46	.38		100	1000
P18-56R-C	.03	5/16"	.91	.46	.38	100	1000		
P18-38R-C	.03	3/8"	1.0	.53	.43	100	1000		
P14-4R-C	16-14 AWG	.03	#4	.62	.25	.20	CT-100‡, CT-200‡, CT-600‡, CT-1570‡	100	1000
P14-6R-C		.03	#6	.62	.25	.20		100	1000
P14-8R-C		.03	#8	.71	.31	.25		100	1000
P14-10R-C		.03	#10	.71	.31	.25		100	1000
P14-12R-L		.03	1/2"	1.20	.72	.53		50	500
P14-14R-C		.03	1/4"	.91	.46	.38		100	1000
P14-56R-C		.03	5/16"	.91	.46	.38		100	1000
P14-38R-C	.03	3/8"	1.0	.53	.43	100	1000		
P10-6R-L	12-10 AWG	.04	#6	.78	.31	.31	CT-100‡, CT-200‡, CT-600‡, CT-1570‡	50	500
P10-8R-L		.04	#8	.78	.31	.31		50	500
P10-10R-L		.04	#10	.81	.38	.31		50	500
P10-12R-L		.04	1/2"	1.20	.72	.53		50	500
P10-14R-L		.04	1/4"	.96	.52	.38		50	500
P10-56R-L		.04	5/16"	.96	.52	.38		50	500
P10-38R-L		.04	3/8"	1.04	.58	.44		50	500

*Wire sizes #26-22 AWG, are not UL Listed or CSA Certified.

**To order in bulk, replace -C in the part number with -M for a bulk package of 1000 and replace -L with -D for a bulk package of 500.

‡UL and CSA approved tooling/product combinations.

System Overview

Terminals

Disconnects

Splices

Ferrules

Compression Connectors

Crimping Tools

Mechanical Connectors

Grounding Connectors

Support Products

Technical Info

Index

System Overview



Multiple Stud Terminal, Non-Insulated

Type P-610R

- Brazed seam
- Single terminal for #6, #8, and #10 size studs



Terminals

Disconnects

Splices

Ferrules

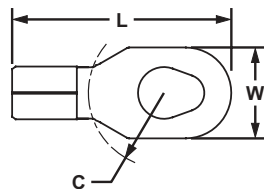

Part Number	Wire Range	Stock Thickness	Stud Size	Figure Dimensions (In.)			Crimp Tool	Std. Pkg. Qty.**	Std. Ctn. Qty.
				L	W	C			
P18-610R-C	22-18 AWG	.03	#6, #8, #10	.80	.31	.25	CT-100‡, CT-200‡, CT-600‡, CT-1570‡	100	500
P14-610R-C	16-14 AWG	.03		.80	.31	.25		100	500
P10-610R-L	12-10 AWG	.04		.90	.37	.31		50	500

**To order in bulk, replace -C in the part number with -M for a bulk package of 1000 and replace -L with -D for a bulk package of 500.

‡UL and CSA approved tooling/product combinations.

Compression Connectors

Ring Terminal, Non-Insulated – High Temperature

Type P-RHT

- Nickel plated copper
- Brazed seam
- Beveled wire lead-in
- For temperatures up to 650°F (343°C)



Crimping Tools

Mechanical Connectors

Grounding Connectors

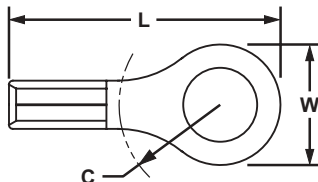

Part Number	Wire Range	Stock Thickness	Stud Size	Figure Dimensions (In.)			Crimp Tool	Std. Pkg. Qty.**	Std. Ctn. Qty.
				L	W	C			
P18-6RHT6-C	22-18 AWG	.03	#6	.62	.25	.21	CT-100, CT-160, CT-200, CT-260, CT-600, CT-1570	100	1000
P18-8RHT6-C		.03	#8	.71	.31	.25		100	1000
P18-10RHT6-C		.03	#10	.71	.31	.25		100	1000
P14-6RHT6-C	16-14 AWG	.03	#6	.62	.25	.20	CT-100, CT-160, CT-200, CT-260, CT-600, CT-1570	100	1000
P14-8RHT6-C		.03	#8	.71	.31	.25		100	1000
P14-10RHT6-C		.03	#10	.71	.31	.25		100	1000
P10-6RHT6-L	12-10 AWG	.04	#6	.78	.31	.35	CT-100, CT-160, CT-200, CT-260, CT-600, CT-1570	50	500
P10-8RHT6-L		.04	#8	.78	.31	.35		50	500
P10-10RHT6-L		.04	#10	.81	.38	.33		50	500
P10-14RHT6-L		.04	1/4"	.96	.53	.42		50	500

**To order in bulk, replace -C in the part number with -M for a bulk package of 1000 and replace -L with -D for a bulk package of 500.

Support Products

Technical Info

Index



Ring Terminal, Heavy Duty Non-Insulated

Type P-HDR

- Brazed seam
- Beveled wire lead-in

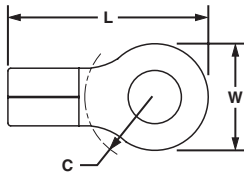

Part Number	Wire Range	Stock Thickness	Stud Size	Figure Dimensions (In.)			Crimp Tool	Std. Pkg. Qty.**	Std. Ctn. Qty.
				L	W	C			
P12-6HDR-L	16-12 AWG	.05	#6	.78	.31	.36	CT-100, CT-200, CT-1570‡	50	500
P12-8HDR-L		.05	#8	.78	.31	.36		50	500
P12-10HDR-L		.05	#10	.81	.37	.36		50	500
P12-14HDR-L		.05	1/4"	.96	.52	.43		50	500
P12-56HDR-L		.05	5/16"	.96	.52	.43		50	500
P12-38HDR-L		.05	3/8"	1.04	.58	.48		50	500

**To order in bulk, replace -L with -D for a bulk package of 500.

‡UL and CSA approved tooling/product combinations.



Ring Terminal, Large Wire Non-Insulated

Type P-R

- Brazed seam
- Beveled wire lead-in

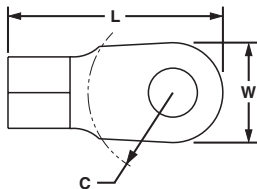

Part Number	Wire Range	Stock Thickness	Stud Size	Figure Dimensions (In.)			Crimp Tool	Std. Pkg. Qty.**	Std. Ctn. Qty.
				L	W	C			
P8-8R-Q	8 AWG	.04	#8	1.12	.42	.43	CT-1701‡	25	250
P8-10R-Q		.04	#10	1.14	.47	.43		25	250
P8-14R-Q		.04	1/4"	1.14	.47	.43		25	250
P8-56R-Q		.04	5/16"	1.25	.59	.51		25	250
P8-38R-Q		.04	3/8"	1.25	.59	.51		25	250
P8-12R-Q		.04	1/2"	1.36	.82	.51		25	250
P6-8R-E	6 AWG	.05	#8	1.21	.47	.43	CT-1701‡	20	200
P6-10R-E		.05	#10	1.21	.47	.43		20	200
P6-14R-E		.05	1/4"	1.21	.47	.43		20	200
P6-56R-E		.05	5/16"	1.33	.62	.51		20	200
P6-38R-E		.05	3/8"	1.33	.62	.51		20	200
P6-12R-E		.05	1/2"	1.43	.82	.51		20	200
P4-10R-E	4 AWG	.05	#10	1.40	.55	.50	CT-1701‡	20	200
P4-14R-E		.05	1/4"	1.40	.55	.50		20	200
P4-56R-E		.05	5/16"	1.46	.68	.50		20	200
P4-38R-E		.05	3/8"	1.46	.68	.50		20	200
P4-12R-E		.05	1/2"	1.55	.86	.53		20	200
P2-10R-X		2 AWG	.06	#10	1.46	.68		.58	CT-1701‡
P2-14R-X	.06		1/4"	1.46	.68	.58	10	100	
P2-56R-X	.06		5/16"	1.46	.68	.58	10	100	
P2-38R-X	.06		3/8"	1.46	.68	.58	10	100	
P2-12R-X	.06		1/2"	1.55	.86	.58	10	100	

**To order in bulk, replace -Q, -E, or -X in the part number with -T for a bulk package of 200.

‡UL and CSA approved tooling/product combinations.

System Overview

Terminals

Disconnects

Splices

Ferrules

Compression Connectors

Crimping Tools

Mechanical Connectors

Grounding Connectors

Support Products

Technical Info

Index

System Overview



Tubular Ring Terminal, Non-Insulated

Type S-R

- Seamless tubular barrel
- Beveled wire lead-in
- Double thick tongue

Terminals

Disconnects



Splices

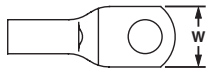

Ferrules

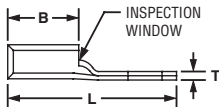

Compression Connectors

Performance Requirements				
Min. Tensile Strength	#8	#6	#4	#2
	90	100	140	180

Crimping Tools

Mechanical Connectors

Grounding Connectors

Support Products

Technical Info

Index

Part Number	Wire Range	Stud Hole Size	Tongue Width	Figure Dimensions (In.)			Crimp Tool	Std. Pkg. Qty.**	Std. Ctn. Qty.
			W	L	B	T			
S8-10R-Q	8 AWG	#10	.41	1.10	.40	.08	CT-1700, CT-720, CT-930, CT-930CH, CT-940CH, CT-2001, CT-2002	25	250
S8-14R-Q		1/4"	.48	1.20	.40	.07		25	250
S8-56R-Q		5/16"	.60	1.30	.40	.05		25	250
S8-38R-Q		3/8"	.60	1.40	.40	.05		25	250
S6-10R-E	6 AWG	#10	.45	1.20	.48	.09		20	200
S6-14R-E		1/4"	.48	1.30	.48	.08		20	200
S6-56R-E		5/16"	.56	1.40	.48	.07		20	200
S6-38R-E	4 AWG	3/8"	.62	1.50	.48	.06		20	200
S4-10R-E		#10	.55	1.20	.48	.09		20	200
S4-14R-E		1/4"	.55	1.30	.48	.09		20	200
S4-56R-E		5/16"	.55	1.40	.48	.09		20	200
S4-38R-E	1-2 AWG	3/8"	.62	1.38	.48	.07		20	200
S2-10R-X		#10	.70	1.60	.59	.11		10	100
S2-14R-X		1/4"	.70	1.60	.59	.11		10	100
S2-56R-X		5/16"	.70	1.70	.59	.11		10	100
S2-38R-X		3/8"	.70	1.70	.59	.11		10	100
S2-12R-X		1/2"	.79	1.90	.59	.09		10	100
S1/0-14R-X	1/0 AWG	1/4"	.76	1.60	.58	.12		10	100
S1/0-56R-X		5/16"	.76	1.70	.58	.12		10	100
S1/0-38R-X		3/8"	.76	1.70	.58	.12		10	100
S1/0-12R-X	2/0 AWG	1/2"	.82	1.90	.58	.12	10	100	
S2/0-14R-X		1/4"	.85	1.90	.66	.13	10	100	
S2/0-56R-X		5/16"	.85	1.90	.66	.13	10	100	
S2/0-38R-X		3/8"	.85	1.90	.66	.13	10	100	
S2/0-76R-X		7/16"	.85	2.10	.66	.13	10	100	
S2/0-12R-X		1/2"	.85	2.10	.66	.13	10	100	
S3/0-14R-5	3/0 AWG	1/4"	.94	2.11	.83	.10	5	50	
S3/0-56R-5		5/16"	.94	2.09	.83	.10	5	50	
S3/0-38R-5		3/8"	.94	2.16	.83	.10	5	50	
S3/0-76R-5		7/16"	.94	2.17	.83	.10	5	50	
S3/0-12R-5	4/0 AWG	1/2"	.94	2.17	.83	.10	5	50	
S4/0-56R-5		5/16"	1.03	2.37	.91	.11	5	50	
S4/0-38R-5		3/8"	1.03	2.37	.91	.11	5	50	
S4/0-76R-5		7/16"	1.03	2.40	.91	.11	5	50	
S4/0-12R-5		1/2"	1.03	2.40	.91	.11	5	50	
S250-56R-5		250 kcmil	5/16"	1.12	2.61	1.01	.12	5	50
S250-38R-5	3/8"		1.12	2.63	1.01	.12	5	50	
S250-76R-5	7/16"		1.12	2.74	1.01	.12	5	50	
S250-12R-5	1/2"		1.12	2.74	1.01	.12	5	50	

**To order in bulk, replace -Q, -E, or -X in the part number with -T for a bulk package of 200 and replace -5 with -C for a bulk package of 100.



Fork Terminal, Nylon Insulated

Type PN-F

- Insulation grip sleeve

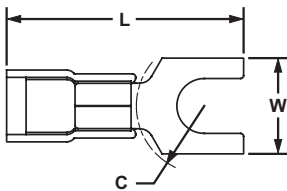

Part Number	Wire Range	Color Code	Stock Thickness	Max. Ins.	Stud Size	Figure Dimensions (In.)			Crimp Tool	Std. Pkg. Qty.**	Std. Ctn. Qty.
						L	W	C			
PN22-2F-C*	26-22 AWG	Yellow	.02	.090	#2	.66	.20	.19	CT-100, CT-600, CT-1525	100	1000
PN22-4F-C*			.02	.090	#4	.67	.20	.21		100	1000
PN22-6F-C*			.02	.090	#6	.77	.25	.26		100	1000
PN18-6FN-C*	22-18 AWG	Red	.03	.145	#6	.78	.24	.20	CT-100‡, CT-600‡, CT-1550‡, CT-1551‡	100	500
PN18-6F-C			.03	.145	#6	.78	.30	.20		100	500
PN18-8F-C			.03	.145	#8	.85	.32	.23		100	500
PN18-10FN-C*			.03	.145	#10	.86	.31	.25		100	500
PN18-10F-C			.03	.145	#10	.86	.35	.25		100	500
PN14-6FN-C*	16-14 AWG	Blue	.03	.162	#6	.79	.24	.19	CT-100‡, CT-600‡, CT-1550‡, CT-1551‡	100	500
PN14-6F-C			.03	.162	#6	.79	.28	.19		100	500
PN14-8F-C			.03	.162	#8	.85	.31	.23		100	500
PN14-10FN-C*			.03	.162	#10	.87	.31	.24		100	500
PN14-10F-C			.03	.162	#10	.87	.34	.24		100	500
PN14-14F-C	.03	.162	1/4"	1.02	.44	.32	100	500			
PN10-6F-L	12-10 AWG	Yellow	.04	.225	#6	1.02	.31	.22	CT-100‡, CT-600‡, CT-1550‡, CT-1551‡	50	500
PN10-8F-L			.04	.225	#8	1.05	.37	.22		50	500
PN10-10F-L			.04	.225	#10	1.05	.37	.22		50	500
PN10-14F-L			.04	.225	1/4"	1.16	.49	.30		50	500

*Not UL Listed or CSA Certified.

**To order in bulk, replace -C in the part number with -M for a bulk package of 1000 and replace -L with -D for a bulk package of 500.

‡UL and CSA approved tooling/product combinations.



Fork Terminal, Nylon Insulated – Funnel Entry

Type PNF-F

- Insulation grip sleeve

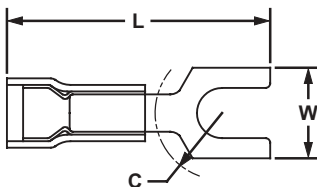
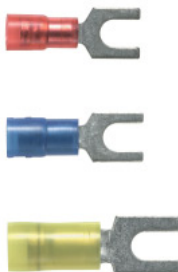

Part Number	Wire Range	Color Code	Stock Thickness	Max. Ins.	Stud Size	Figure Dimensions (In.)			Crimp Tool	Std. Pkg. Qty.**	Std. Ctn. Qty.
						L	W	C			
PNF18-6F-C	22-18 AWG	Red	.03	.145	#6	.80	.30	.22	CT-100‡, CT-600‡, CT-1550‡, CT-1551‡	100	500
PNF18-8F-C			.03	.145	#8	.86	.31	.25		100	500
PNF18-10F-C			.03	.145	#10	.87	.34	.26		100	500
PNF18-14F-C			.03	.145	1/4"	1.05	.44	.32		100	500
PNF14-6F-C	16-14 AWG	Blue	.03	.162	#6	.80	.28	.22	CT-100‡, CT-600‡, CT-1550‡, CT-1551‡	100	500
PNF14-8F-C			.03	.162	#8	.85	.31	.25		100	500
PNF14-10F-C			.03	.162	#10	.87	.34	.26		100	500
PNF14-14F-C	.03	.162	1/4"	1.05	.44	.35	100	500			
PNF10-6F-L	12-10 AWG	Yellow	.04	.225	#6	1.00	.31	.24	CT-100‡, CT-600‡, CT-1550‡, CT-1551‡	50	500
PNF10-8F-L			.04	.225	#8	1.08	.37	.24		50	500
PNF10-10F-L			.04	.225	#10	1.08	.37	.24		50	500
PNF10-14F-L			.04	.225	1/4"	1.18	.50	.31		50	500

**To order in bulk, replace -C in the part number with -M for a bulk package of 1000 and replace -L with -D for a bulk package of 500.

‡UL and CSA approved tooling/product combinations.

System Overview

Terminals

Disconnects

Splices

Ferrules

Compression Connectors

Crimping Tools

Mechanical Connectors

Grounding Connectors

Support Products

Technical Info

Index

System Overview



Fork Terminal, Vinyl Insulated – Funnel Entry

Type PV-F

- Insulation support
- Brazed seam

Terminals



Disconnects



Splices



Ferrules

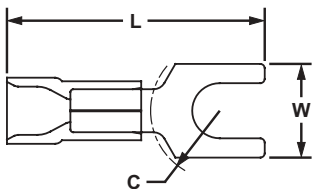

Part Number	Wire Range	Color Code	Stock Thickness	Max. Ins.	Stud Size	Figure Dimensions (In.)			Crimp Tool	Std. Pkg. Qty.**	Std. Ctn. Qty.
						L	W	C			
PV22-2F-C*	26-22 AWG	Yellow	.02	.110	#2	.65	.21	.18	CT-100, CT-600, CT-1525	100	1000
PV22-4F-C*			.02	.110	#4	.67	.20	.21		100	1000
PV22-6F-C*			.02	.110	#6	.76	.25	.26		100	1000
PV18-6FN-C*	22-18 AWG	Red	.03	.158	#6	.86	.24	.21	CT-100‡, CT-600‡, CT-1550‡, CT-1551‡	100	500
PV18-6F-C			.03	.158	#6	.85	.30	.25		100	500
PV18-8F-C			.03	.158	#8	.93	.32	.25		100	500
PV18-10FN-C*	22-18 AWG	Red	.03	.158	#10	.93	.31	.25	CT-100‡, CT-600‡, CT-1550‡, CT-1551‡	100	500
PV18-10F-C			.03	.158	#10	.93	.35	.25		100	500
PV14-6FN-C*			16-14 AWG	Blue	.03	.170	#6	.84		.24	.20
PV14-6F-C	.03	.170			#6	.84	.28	.20	100	500	
PV14-8F-C	.03	.170			#8	.90	.31	.23	100	500	
PV14-10FN-C*	.03	.170			#10	.92	.31	.25	100	500	
PV14-10F-C	.03	.170			#10	.92	.34	.25	100	500	
PV14-14F-C	12-10 AWG	Yellow	.03	.170	1/4"	1.09	.44	.32	CT-100‡, CT-600‡, CT-1550‡, CT-1551‡	100	1000
PV10-6F-L			.04	.225	#6	1.01	.31	.25		50	500
PV10-8F-L			.04	.225	#8	1.04	.37	.25		50	500
PV10-10F-L			.04	.225	#10	1.04	.37	.25		50	500
PV10-14F-L			.04	.225	1/4"	1.14	.49	.32		50	500

*Not UL Listed or CSA Certified.

**To order in bulk, replace -C in the part number with -M for a bulk package of 1000 and replace -L with -D for a bulk package of 500.

‡UL and CSA approved tooling/product combinations.

Compression Connectors

Crimping Tools



Fork Terminal, Vinyl Insulated – Expanded Insulation

Type PV-FX

- For large wire insulation O.D.
- Insulation support
- Brazed seam

Grounding Connectors



Support Products



Part Number	Wire Range	Color Code	Stock Thickness	Max. Ins.	Stud Size	Figure Dimensions (In.)			Crimp Tool	Std. Pkg. Qty.**	Std. Ctn. Qty.
						L	W	C			
PV18-6FX-C	22-18 AWG	Red	.03	.163	#6	.90	.30	.20	CT-100‡, CT-600‡, CT-1550‡, CT-1551‡	100	500
PV18-8FX-C			.03	.163	#8	.97	.32	.23		100	500
PV18-10FX-C			.03	.163	#10	.97	.35	.25		100	500
PV14-6FX-C	16-14 AWG	Blue	.03	.200	#6	.89	.28	.16	CT-100‡, CT-600‡, CT-1550‡, CT-1551‡	100	500
PV14-8FX-C			.03	.200	#8	.96	.31	.20		100	500
PV14-10FX-C			.03	.200	#10	.97	.34	.22		100	500
PV10-8FX-L	12-10 AWG	Yellow	.04	.250	#8	1.11	.37	.24	CT-100‡, CT-600‡, CT-1550‡, CT-1551‡	50	500
PV10-10FX-L			.04	.250	#10	1.11	.37	.24		50	500
PV10-14FX-L			.04	.250	1/4"	1.22	.50	.32		50	500

**To order in bulk, replace -C in the part number with -M for a bulk package of 1000 and replace -L with -D for a bulk package of 500.

‡UL and CSA approved tooling/product combinations.

Technical Info

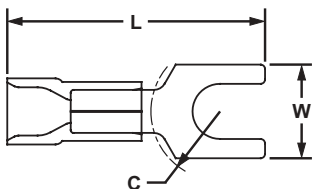

Index



Locking Fork Terminal, Nylon Insulated

Type PN-LF

- Insulation grip sleeve

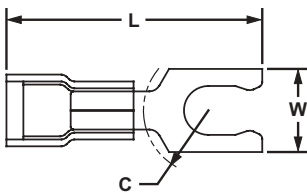
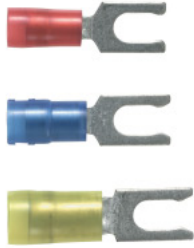

Part Number	Wire Range	Color Code	Stock Thickness	Max. Ins.	Stud Size	Figure Dimensions (In.)			Crimp Tool	Std. Pkg. Qty.**	Std. Ctn. Qty.
						L	W	C			
PN18-6LF-C	22-18 AWG	Red	.03	.145	#6	.82	.27	.22	CT-100‡, CT-600‡, CT-1550‡, CT-1551‡	100	500
PN18-6LFW-C			.03	.145	#6	.85	.29	.22			
PN18-8LF-C			.03	.145	#8	.89	.29	.25			
PN18-10LF-C			.03	.145	#10	.89	.33	.25			
PN18-10LFN-C*			.03	.145	#10	.91	.29	.25			
PN14-6LF-C	16-14 AWG	Blue	.03	.162	#6	.86	.25	.22	CT-100‡, CT-600‡, CT-1550‡, CT-1551‡	100	500
PN14-6LFW-C			.03	.162	#6	.84	.29	.22			
PN14-8LF-C			.03	.162	#8	.92	.29	.25			
PN14-10LF-C			.03	.162	#10	.91	.33	.25			
PN14-10LFN-C*			.03	.162	#10	.91	.28	.25			
PN10-6LF-L	12-10 AWG	Yellow	.04	.225	#6	1.03	.30	.23	CT-100‡, CT-600‡, CT-1550‡, CT-1551‡	50	500
PN10-8LF-L			.04	.225	#8	1.05	.30	.23			
PN10-10LF-L			.04	.225	#10	1.05	.34	.23			
PN10-14LF-L			.04	.225	1/4"	1.19	.46	.32			

*Not UL Listed or CSA Certified.

**To order in bulk, replace -C in the part number with -M for a bulk package of 1000 and replace -L with -D for a bulk package of 500.

‡UL and CSA approved tooling/product combinations.



Locking Fork Terminal, Nylon Insulated – Funnel Entry

Type PNF-LF

- Insulation grip sleeve

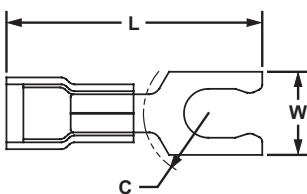
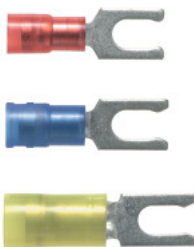

Part Number	Wire Range	Color Code	Stock Thickness	Max. Ins.	Stud Size	Figure Dimensions (In.)			Crimp Tool	Std. Pkg. Qty.**	Std. Ctn. Qty.
						L	W	C			
PNF18-6LF-C	22-18 AWG	Red	.03	.145	#6	.82	.27	.20	CT-100‡, CT-600‡, CT-1550‡, CT-1551‡	100	500
PNF18-6LFW-C			.03	.145	#6	.85	.29	.20			
PNF18-8LF-C			.03	.145	#8	.89	.29	.26			
PNF18-10LF-C			.03	.145	#10	.89	.33	.25			
PNF14-6LF-C			16-14 AWG	Blue	.03	.162	#6	.87			
PNF14-6LFW-C	.03	.162			#6	.84	.29	.20			
PNF14-8LF-C	.03	.162			#8	.93	.29	.25			
PNF14-10LF-C	.03	.162			#10	.93	.33	.25			
PNF10-6LF-L	12-10 AWG	Yellow			.04	.225	#6	1.06	.30	.20	CT-100‡, CT-600‡, CT-1550‡, CT-1551‡
PNF10-8LF-L			.04	.225	#8	1.08	.30	.20			
PNF10-10LF-L			.04	.225	#10	1.08	.34	.22			
PNF10-14LF-L			.04	.225	1/4"	1.21	.46	.33			

**To order in bulk, replace -C in the part number with -M for a bulk package of 1000 and replace -L with -D for a bulk package of 500.

‡UL and CSA approved tooling/product combinations.

System Overview

Terminals

Disconnects

Splices

Ferrules

Compression Connectors

Crimping Tools

Mechanical Connectors

Grounding Connectors

Support Products

Technical Info

Index

PANDUIT® TERMINATION SOLUTIONS

System Overview Locking Fork Terminal, Vinyl Insulated – Funnel Entry

Type PV-LF

- Insulation support
- Brazed seam

Terminals



Disconnects



Splices



Ferrules

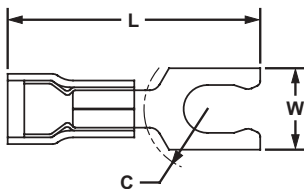

Part Number	Wire Range	Color Code	Stock Thickness	Max. Ins.	Stud Size	Figure Dimensions (In.)			Crimp Tool	Std. Pkg. Qty.**	Std. Ctn. Qty.
						L	W	C			
PV18-6LF-C	22-18 AWG	Red	.03	.158	#6	.90	.27	.22	CT-100‡, CT-600‡, CT-1550‡, CT-1551‡	100	500
PV18-6LFW-C			.03	.158	#6	.90	.29	.22		100	500
PV18-8LF-C			.03	.158	#8	.97	.29	.25		100	500
PV18-10LF-C			.03	.158	#10	.97	.33	.25		100	500
PV18-10LFN-C*			.03	.158	#10	.97	.29	.25		100	500
PV14-6LF-C	16-14 AWG	Blue	.03	.170	#6	.90	.25	.22	CT-100‡, CT-600‡, CT-1550‡, CT-1551‡	100	500
PV14-6LFW-C			.03	.170	#6	.90	.29	.22		100	500
PV14-8LF-C			.03	.170	#8	.97	.29	.25		100	500
PV14-10LF-C			.03	.170	#10	.97	.33	.25		100	500
PV14-10LFN-C*			.03	.170	#10	.97	.29	.25	100	500	
PV10-6LF-L	12-10 AWG	Yellow	.04	.225	#6	1.03	.30	.23	CT-100‡, CT-600‡, CT-1550‡, CT-1551‡	50	500
PV10-8LF-L			.04	.225	#8	1.05	.30	.23		50	500
PV10-10LF-L			.04	.225	#10	1.04	.34	.23		50	500
PV10-14LF-L			.04	.225	1/4"	1.19	.46	.36		50	500

*Not UL Listed or CSA Certified.

**To order in bulk, replace -C in the part number with -M for a bulk package of 1000 and replace -L with -D for a bulk package of 500.

‡UL and CSA approved tooling/product combinations.

Compression Connectors



Locking Fork Terminal, Vinyl Insulated – Expanded Insulation

Type PV-LFX

- Insulation support
- For large wire insulation O.D.
- Brazed seam

Crimping Tools



Mechanical Connectors



Grounding Connectors



Support Products

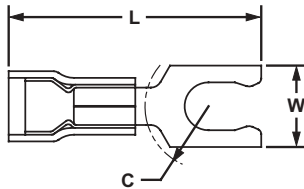

Part Number	Wire Range	Color Code	Stock Thickness	Max. Ins.	Stud Size	Figure Dimensions (In.)			Crimp Tool	Std. Pkg. Qty.**	Std. Ctn. Qty.
						L	W	C			
PV18-6LFX-C	22-18 AWG	Red	.03	.170	#6	.95	.27	.20	CT-100‡, CT-600‡, CT-1550‡, CT-1551‡	100	500
PV18-8LFX-C			.03	.170	#8	1.00	.29	.20		100	500
PV18-10LFX-C			.03	.170	#10	1.04	.33	.23		100	500
PV14-6LFX-C	16-14 AWG	Blue	.03	.200	#6	.95	.25	.20	CT-100‡, CT-600‡, CT-1550‡, CT-1551‡	100	500
PV14-8LFX-C			.03	.200	#8	1.01	.29	.23		100	500
PV14-10LFX-C			.03	.200	#10	1.01	.33	.23		100	500
PV10-6LFX-L	12-10 AWG	Yellow	.04	.250	#6	1.09	.30	.23	CT-100‡, CT-600‡, CT-1550‡, CT-1551‡	50	500
PV10-8LFX-L			.04	.250	#8	1.12	.30	.23		50	500
PV10-10LFX-L			.04	.250	#10	1.12	.34	.23		50	500
PV10-14LFX-L			.04	.250	1/4"	1.25	.46	.35		50	500

**To order in bulk, replace -C in the part number with -M for a bulk package of 1000 and replace -L with -D for a bulk package of 500.

‡UL and CSA approved tooling/product combinations.

Technical Info

Index



Short Locking Fork Terminal, Nylon Insulated

Type PN-SLF

- Insulation grip sleeve

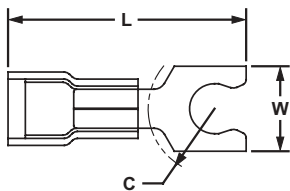

Part Number	Wire Range	Color Code	Stock Thickness	Max. Ins.	Stud Size	Figure Dimensions (In.)			Crimp Tool	Std. Pkg. Qty.**	Std. Ctn. Qty.
						L	W	C			
PN18-5SLF-C	22-18 AWG	Red	.03	.145	#5	.75	.26	.09	CT-1550, CT-1551	100	500
PN18-6SLF-C			.03	.145	#6	.75	.27	.19		100	500
PN18-8SLF-C			.03	.145	#8	.80	.29	.23		100	500
PN18-10SLF-C			.03	.145	#10	.81	.33	.23		100	500
PN14-5SLF-C	16-14 AWG	Blue	.03	.162	#5	.75	.25	.19	CT-1550, CT-1551	100	500
PN14-6SLF-C			.03	.162	#6	.75	.25	.19		100	500
PN14-8SLF-C			.03	.162	#8	.82	.29	.23		100	500
PN14-10SLF-C			.03	.162	#10	.81	.33	.23		100	500
PN14-14SLF-C			.03	.162	1/4"	.90	.44	.28		100	500
PN10-5SLF-L	12-10 AWG	Yellow	.04	.225	#5	.84	.25	.22	CT-1550, CT-1551	50	500
PN10-6SLF-L			.04	.225	#6	.84	.25	.22		50	500
PN10-8SLF-L			.04	.225	#8	.89	.29	.26		50	500
PN10-10SLF-L			.04	.225	#10	.90	.33	.26		50	500
PN10-14SLF-L			.04	.225	1/4"	.99	.45	.33		50	500

**To order in bulk, replace -C in the part number with -M for a bulk package of 1000 and replace -L with -D for a bulk package of 500.

Short Locking Fork Terminal, Nylon Insulated – Funnel Entry

Type PNF-SLF

- Insulation grip sleeve

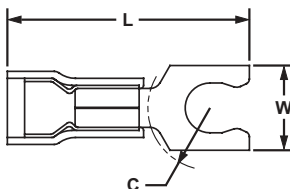

Part Number	Wire Range	Color Code	Stock Thickness	Max. Ins.	Stud Size	Figure Dimensions (In.)			Crimp Tool	Std. Pkg. Qty.**	Std. Ctn. Qty.
						L	W	C			
PNF18-5SLF-C	22-18 AWG	Red	.03	.145	#5	.75	.26	.19	CT-1550, CT-1551	100	500
PNF18-6SLF-C			.03	.145	#6	.75	.27	.19		100	500
PNF18-8SLF-C			.03	.145	#8	.80	.29	.23		100	500
PNF18-10SLF-C			.03	.145	#10	.81	.33	.23		100	500
PNF14-5SLF-C	16-14 AWG	Blue	.03	.162	#5	.75	.25	.22	CT-1550, CT-1551	100	500
PNF14-6SLF-C			.03	.162	#6	.75	.25	.22		100	500
PNF14-8SLF-C			.03	.162	#8	.82	.29	.26		100	500
PNF14-10SLF-C			.03	.162	#10	.81	.33	.25		100	500
PNF14-14SLF-C			.03	.162	1/4"	.91	.44	.30		100	500
PNF10-6SLF-L	12-10 AWG	Yellow	.04	.225	#6	.90	.25	.17	CT-1550, CT-1551	50	500
PNF10-8SLF-L			.04	.225	#8	.95	.29	.22		50	500
PNF10-10SLF-L			.04	.225	#10	.96	.33	.22		50	500
PNF10-14SLF-L			.04	.225	1/4"	1.06	.45	.28		50	500

**To order in bulk, replace -C in the part number with -M for a bulk package of 1000 and replace -L with -D for a bulk package of 500.

System Overview

Terminals

Disconnects

Splices

Ferrules

Compression Connectors

Crimping Tools

Mechanical Connectors

Grounding Connectors

Support Products

Technical Info

Index

System Overview

Short Locking Fork Terminal, Vinyl Insulated – Funnel Entry

Type PV-SLF

- Insulation support
- Butted seam

Terminals



Disconnects



Splices

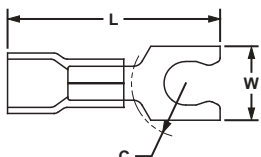

Part Number	Wire Range	Color Code	Stock Thickness	Max. Ins.	Stud Size	Figure Dimensions (In.)			Crimp Tool	Std. Pkg. Qty.**	Std. Ctn. Qty.
						L	W	C			
PV18-5SLF-C	22-18 AWG	Red	.03	.150	#5	.82	.26	.19	CT-1550, CT-1551	100	1000
PV18-6SLF-C			.03	.150	#6	.82	.27	.19			
PV18-8SLF-C			.03	.150	#8	.87	.29	.23			
PV18-10SLF-C			.03	.150	#10	.88	.33	.23			
PV14-5SLF-C	16-14 AWG	Blue	.03	.170	#5	.82	.25	.20	CT-1550, CT-1551	100	1000
PV14-6SLF-C			.03	.170	#6	.82	.25	.20			
PV14-8SLF-C			.03	.170	#8	.89	.29	.23			
PV14-10SLF-C			.03	.170	#10	.89	.33	.23			
PV14-14SLF-C	12-10 AWG	Yellow	.03	.170	1/4"	.97	.44	.33	CT-1550, CT-1551	100	1000
PV10-5SLF-L			.04	.225	#5	.86	.25	.22			
PV10-6SLF-L			.04	.225	#6	.87	.25	.22			
PV10-8SLF-L			.04	.225	#8	.92	.29	.26			
PV10-10SLF-L	12-10 AWG	Yellow	.04	.225	#10	.92	.33	.26	CT-1550, CT-1551	50	500
PV10-14SLF-L			.04	.225	1/4"	1.02	.45	.33			

**To order in bulk, replace -C in the part number with -M for a bulk package of 1000 and replace -L with -D for a bulk package of 500.

Ferrules



Flanged Fork Terminal, Nylon Insulated

Type PN-FF

- Insulation grip sleeve
- For use in vibration applications

Compression Connectors



Crimping Tools



Mechanical Connectors

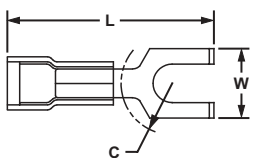

Part Number	Wire Range	Color Code	Stock Thickness	Max. Ins.	Stud Size	Figure Dimensions (In.)			Crimp Tool	Std. Pkg. Qty.**	Std. Ctn. Qty.
						L	W	C			
PN18-6FF-C	22-18 AWG	Red	.03	.136	#6	.81	.28	.20	CT-100‡, CT-600‡, CT-1550‡, CT-1551‡	100	500
PN18-8FF-C			.03	.136	#8	.88	.31	.23			
PN18-10FF-C			.03	.136	#10	.86	.35	.23			
PN14-6FF-C	16-14 AWG	Blue	.03	.162	#6	.79	.28	.20	CT-100‡, CT-600‡, CT-1550‡, CT-1551‡	100	500
PN14-8FF-C			.03	.162	#8	.86	.31	.23			
PN14-10FF-C			.03	.162	#10	.86	.36	.23			
PN10-8FF-L	12-10 AWG	Yellow	.04	.225	#8	1.05	.37	.28	CT-100‡, CT-600‡, CT-1550‡, CT-1551‡	50	500
PN10-10FF-L			.04	.225	#10	1.05	.37	.28			

**To order in bulk, replace -C in the part number with -M for a bulk package of 1000 and replace -L with -D for a bulk package of 500.

‡UL and CSA approved tooling/product combinations.

Grounding Connectors



Flanged Fork Terminal, Vinyl Insulated – Funnel Entry

Type PV-FF

- Insulation support
- Brazed seam

Support Products



Technical Info



Index

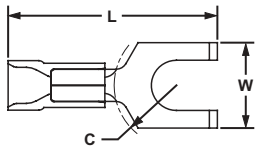

Part Number	Wire Range	Color Code	Stock Thickness	Max. Ins.	Stud Size	Figure Dimensions (In.)			Crimp Tool	Std. Pkg. Qty.**	Std. Ctn. Qty.
						L	W	C			
PV18-6FF-C	22-18 AWG	Red	.03	.140	#6	.87	.28	.19	CT-100‡, CT-600‡, CT-1550‡, CT-1551‡	100	500
PV18-8FF-C			.03	.140	#8	.94	.31	.23			
PV18-10FF-C			.03	.140	#10	.93	.35	.23			
PV14-6FF-C	16-14 AWG	Blue	.03	.165	#6	.88	.28	.19	CT-100‡, CT-600‡, CT-1550‡, CT-1551‡	100	500
PV14-8FF-C			.03	.165	#8	.94	.31	.23			
PV14-10FF-C			.03	.165	#10	.94	.35	.23			
PV10-8FF-L	12-10 AWG	Yellow	.04	.225	#8	1.03	.37	.22	CT-100‡, CT-600‡, CT-1550‡, CT-1551‡	50	500
PV10-10FF-L			.04	.225	#10	1.03	.37	.22			

**To order in bulk, replace -C in the part number with -M for a bulk package of 1000 and replace -L with -D for a bulk package of 500.

‡UL and CSA approved tooling/product combinations.



Fork Terminal, Non-Insulated

Type P-F

- Brazed seam
- Beveled wire lead-in

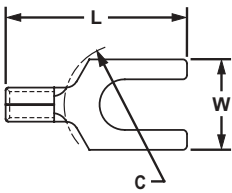

Part Number	Wire Range	Stock Thickness	Stud Size	Figure Dimensions (In.)			Crimp Tool	Std. Pkg. Qty.**	Std. Ctn. Qty.
				L	W	C			
P22-2F-C*	26-22 AWG	.02	#2	.49	.20	.19	CT-100, CT-200	100	1000
P22-4F-C*		.02	#4	.49	.19	.20		100	1000
P22-6F-C*		.02	#6	.59	.25	.26		100	1000
P18-6FN-C*	22-18 AWG	.03	#6	.63	.24	.21	CT-100‡, CT-200‡, CT-600‡, CT-1570‡	100	1000
P18-6F-C		.03	#6	.63	.30	.19		100	1000
P18-8F-C		.03	#8	.69	.32	.25		100	1000
P18-10FN-C*		.03	#10	.71	.31	.25		100	1000
P18-10F-C		.03	#10	.71	.35	.25		100	1000
P18-14F-C		.03	1/4"	.88	.44	.33		100	1000
P14-6FN-C*	16-14 AWG	.03	#6	.63	.24	.20	CT-100‡, CT-200‡, CT-600‡, CT-1570‡	100	1000
P14-6F-C		.03	#6	.63	.28	.20		100	1000
P14-8F-C		.03	#8	.69	.31	.23		100	1000
P14-10FN-C*		.03	#10	.71	.31	.25		100	1000
P14-10F-C		.03	#10	.71	.34	.25		100	1000
P14-14F-C		.03	1/4"	.88	.44	.33		100	1000
P10-6F-L	12-10 AWG	.04	#6	.75	.31	.22	CT-100‡, CT-200‡, CT-600‡, CT-1570‡	50	500
P10-8F-L		.04	#8	.78	.37	.22		50	500
P10-10F-L		.04	#10	.78	.37	.23		50	500
P10-14F-L		.04	1/4"	.89	.50	.30		50	500

*Not UL Listed or CSA Certified.

**To order in bulk, replace -C in the part number with -M for a bulk package of 1000 and replace -L with -D for a bulk package of 500.

‡UL and CSA approved tooling/product combinations.



Flanged Fork Terminal, Non-Insulated

Type P-FF

- Brazed seam
- Beveled wire lead-in

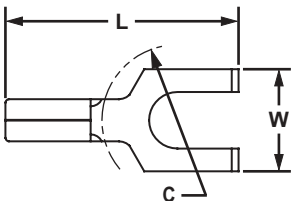

Part Number	Wire Range	Stock Thickness	Stud Size	Figure Dimensions (In.)			Crimp Tool	Std. Pkg. Qty.**	Std. Ctn. Qty.
				L	W	C			
P18-8FF-C	22-18 AWG	.03	#8	.72	.31	.25	CT-100‡, CT-200‡, CT-600‡, CT-1570‡	100	500
P14-6FF-C	16-14 AWG	.03	#6	.65	.28	.20		100	500
P14-8FF-C		.03	#8	.72	.31	.23		100	500
P10-10FF-L	12-10 AWG	.04	#10	.80	.38	.26	50	500	

**To order in bulk, replace -C in the part number with -M for a bulk package of 1000 and replace -L with -D for a bulk package of 500.

‡UL and CSA approved tooling/product combinations.

System Overview

Terminals

Disconnects

Splices

Ferrules

Compression Connectors

Crimping Tools

Mechanical Connectors

Grounding Connectors

Support Products

Technical Info

Index

System Overview



Locking Fork Terminal, Non-Insulated

Type P-LF

- Brazed seam
- Beveled wire lead-in

Terminals



Disconnects



Splices

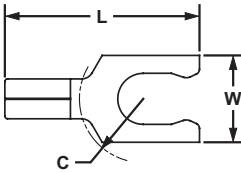

Ferrules

Part Number	Wire Range	Stock Thickness	Stud Size	Figure Dimensions (In.)			Crimp Tool	Std. Pkg. Qty.**	Std. Ctn. Qty.
				L	W	C			
P18-6LF-C	22-18 AWG	.03	#6	.68	.27	.22	CT-100‡, CT-200‡, CT-600‡, CT-1570‡	100	500
P18-6LFW-C		.03	#6	.70	.29	.22		100	500
P18-8LF-C		.03	#8	.74	.29	.23		100	500
P18-10LFN-C*		.03	#10	.74	.28	.23		100	500
P18-10LF-C		.03	#10	.74	.33	.23		100	500
P14-6LF-C	16-14 AWG	.03	#6	.70	.25	.22	CT-100‡, CT-200‡, CT-600‡, CT-1570‡	100	500
P14-6LFW-C		.03	#6	.70	.29	.22		100	500
P14-8LF-C		.03	#8	.77	.29	.27		100	500
P14-10LFN-C*		.03	#10	.77	.29	.27		100	500
P14-10LF-C		.03	#10	.77	.33	.27		100	500
P10-6LF-L	12-10 AWG	.04	#6	.77	.30	.23	CT-100‡, CT-200‡, CT-600‡, CT-1570‡	50	500
P10-8LF-L		.04	#8	.79	.30	.23		50	500
P10-10LF-L		.04	#10	.79	.34	.23		50	500
P10-14LF-L		.04	1/4"	.92	.46	.33		50	500

*Not UL Listed or CSA Certified.

**To order in bulk, replace -C in the part number with -M for a bulk package of 1000 and replace -L with -D for a bulk package of 500.

‡UL and CSA approved tooling/product combinations.

Compression Connectors



Short Locking Fork Terminal, Non-Insulated

Type P-SLF

- Butted seam
- Beveled wire lead-in

Crimping Tools



Mechanical Connectors



Grounding Connectors

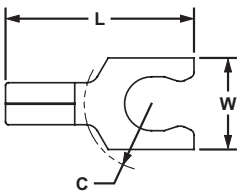

Support Products

Part Number	Wire Range	Stock Thickness	Stud Size	Figure Dimensions (In.)			Crimp Tool	Std. Pkg. Qty.**	Std. Ctn. Qty.
				L	W	C			
P18-6SLF-C	22-18 AWG	.03	#6	.51	.25	.22	CT-100‡, CT-200‡, CT-600‡, CT-1570‡	100	1000
P18-8SLF-C		.03	#8	.56	.29	.25		100	1000
P18-10SLF-C		.03	#10	.57	.33	.25		100	1000
P14-6SLF-C	16-14 AWG	.03	#6	.60	.25	.20	CT-100‡, CT-200‡, CT-600‡, CT-1570‡	100	1000
P14-8SLF-C		.03	#8	.65	.29	.23		100	1000
P14-10SLF-C		.03	#10	.67	.33	.23		100	1000
P14-14SLF-C		.03	1/4"	.76	.44	.33		100	1000
P10-5SLF-L	12-10 AWG	.04	#5	.60	.25	.19	CT-100‡, CT-200‡, CT-600‡, CT-1570‡	50	500
P10-8SLF-L		.04	#8	.66	.29	.23		50	500
P10-10SLF-L		.04	#10	.67	.33	.23		50	500
P10-14SLF-L		.04	1/4"	.76	.45	.28		50	500

**To order in bulk, replace -C in the part number with -M for a bulk package of 1000 and replace -L with -D for a bulk package of 500.

‡UL and CSA approved tooling/product combinations.

Technical Info

Index



Heat Shrink, Fork Terminal

Type PH-F

- Heat shrink polyolefin with hot melt sealant
- Minimum shrink temperature 300°F (150°C)
- Brazed seam
- Adhesive lined heat shrink
- Heat shrink insulated terminals are both air and water tight

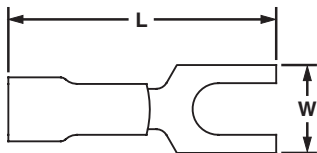

Part Number	Wire Range	Color Code	Max. Ins.	Stud Size	Figure Dimensions (In.)		Wire Strip Length	Crimp Tool	Std. Pkg. Qty.	Std. Ctn. Qty.
					L	W				
PH18-6F-Q	22-18 AWG	Red	.170	#6	1.04	.32	5/16	CT-310	25	125
PH18-8F-Q			.170	#8	1.04	.32	5/16		25	125
PH18-10F-Q			.170	#10	1.04	.32	5/16		25	125
PH14-6F-Q	16-14 AWG	Blue	.190	#6	1.14	.38	5/16	CT-310	25	125
PH14-8F-Q			.190	#8	1.04	.38	5/16		25	125
PH14-10F-Q			.190	#10	1.07	.38	5/16		25	125
PH10-8F-E	12-10 AWG	Yellow	.240	#8	1.15	.38	5/16	CT-310	20	100
PH10-10F-E			.240	#10	1.15	.38	5/16		20	100

System Overview

Terminals

Disconnects

Splices

Ferrules

Compression Connectors

Crimping Tools

Mechanical Connectors

Grounding Connectors

Support Products

Technical Info

Index

System Overview

Features and Benefits — *PAN-TERM*® Metric Terminals

All *PANDUIT*® Terminals feature high quality materials made with electrolytic copper for high conductivity and are tin plated for corrosion resistance.

Terminals

Nylon Insulated Terminals With Insulation Grip Sleeve Type PMN or PMNF

Internal barrel serrations assure good wire contact and maximum tensile strength

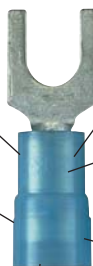

Maximum insulation temperature 105°C (221°F)

Sleeved barrel assures crimp reliability

Insulation grip sleeve provides a superior insulation crimp for high vibration and high strain relief applications

Color coded insulation identifies wire range

Funnel entry for faster insertion and lower installed cost

Disconnects

Splices

Ferrules

Vinyl Insulated Terminals With Insulation Support Type PMV

Internal barrel serrations assure good wire contact and maximum tensile strength



Maximum insulation temperature 105°C (221°F)

Color coded insulation identifies wire range

Brazed seam assures crimp reliability

Insulation crimp provides insulation support to protect electrical crimp

Funnel entry for faster insertion and lower installed cost

Compression Connectors

**Flammability – UL94V-21HB*

*Proprietary blend of UL94V-2 and UL94HB flammability related materials.

**Flammability – UL94V-0.

Crimping Tools

Non-Insulated Terminals

Type PM

Product markings provide easy identification of wire size



Maximum recommended operating temperature 150°C (302°F)

Extended barrel length assures a good quality crimp and makes crimping easier

Brazed seam assures crimp reliability

Internal barrel serrations assure good wire contact and maximum tensile strength

Internally beveled barrel for quick easy wire insertion

Mechanical Connectors

Grounding Connectors

Support Products

Technical Info

Index

Part Number System for *PAN-TERM*® Metric Terminals

PM	V	1	—	3	R	—	B	—	C
Type	Insulation	Wire Range		Stud Size	Tongue Configuration		Special Configuration		Std. Pkg. Size
PM = <i>PAN-TERM</i> ® Metric	N = Nylon NF = Nylon Funnel V = Vinyl	1 = .5-1.0mm ² 2 = 1.5-2.5mm ² 6 = 4.0-6.0mm ²		3 = M3 4 = M4 5 = M5 6 = M6 8 = M8	R = Ring F = Fork P = Pin		B = Butted Seam		X = 10 E = 20 Q = 25 L = 50 C = 100

Metric Ring Terminal, Nylon Insulated – Funnel Entry

Type PMNF-R

- Insulation grip sleeve

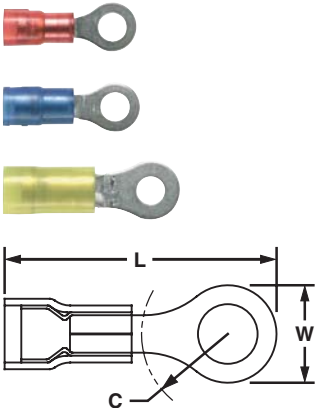

Part Number	Wire Range	Color Code	Max. Ins.	Stud Size	Figure Dimensions (mm)			Crimp Tool	Std. Pkg. Qty.	Std. Ctn. Qty.
					L	W	C			
PMNF1-3R-C	.5-1.0	Red	4.01	M3	19.7	5.9	5.2	CT-1550	100	500
PMNF1-4R-C			4.01	M4	21.5	7.9	6.4		100	500
PMNF1-5R-C			4.01	M5	22.1	8.9	6.4		100	500
PMNF1-6R-C			4.01	M6	26.3	10.9	9.7		100	500
PMNF2-3R-C	1.5-2.5	Blue	4.27	M3	19.2	5.9	5.1	CT-1550	100	500
PMNF2-4R-C			4.27	M4	21.7	7.9	6.5		100	500
PMNF2-5R-C			4.27	M5	22.2	8.9	6.5		100	500
PMNF2-6R-C			4.27	M6	26.5	10.9	9.7		100	500
PMNF6-3R-L	2.5-6.0	Yellow	5.84	M3	26.1	6.0	7.8	CT-1550	50	250
PMNF6-4R-L			5.84	M4	27.1	8.0	7.8		50	250
PMNF6-5R-L			5.84	M5	27.9	9.5	7.8		50	250
PMNF6-6R-L			5.84	M6	30.0	10.9	9.7		50	250
PMNF6-8R-L			5.84	M8	32.0	13.3	9.7		50	250

Metric Ring Terminal, Vinyl Insulated – Funnel Entry

Type PMV-R

- Insulation support

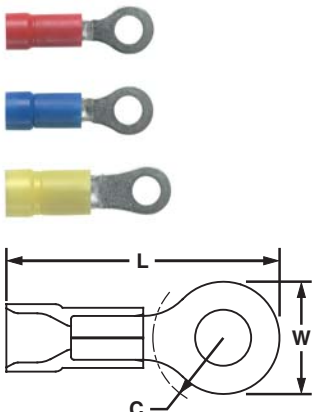

Part Number	Wire Range	Color Code	Max. Ins.	Stud Size	Figure Dimensions (mm)			Crimp Tool	Std. Pkg. Qty.	Std. Ctn. Qty.
					L	W	C			
PMV1-3RB-C	.5-1.0	Red	3.91	M3	21.3	5.9	5.2	CT-1550	100	500
PMV1-4RB-C			3.91	M4	23.6	7.9	6.4		100	500
PMV1-5RB-C			3.91	M5	24.0	8.9	6.4		100	500
PMV1-6RB-C			3.91	M6	28.8	10.9	9.7		100	500
PMV2-3RB-C	1.5-2.5	Blue	4.47	M3	20.5	5.9	5.1	CT-1550	100	500
PMV2-4RB-C			4.47	M4	23.2	7.9	6.5		100	500
PMV2-5RB-C			4.47	M5	23.8	8.9	6.5		100	500
PMV2-6RB-C			4.47	M6	27.8	10.9	9.7		100	500
PMV6-3R-L	2.5-6.0	Yellow	5.97	M3	26.0	6.0	7.8	CT-1550	50	250
PMV6-4R-L			5.97	M4	26.4	8.0	7.8		50	250
PMV6-5R-L			5.97	M5	27.3	9.5	7.8		50	250
PMV6-6R-L			5.97	M6	30.1	10.9	9.7		50	250
PMV6-8R-L			5.97	M8	31.4	13.3	9.7		50	250

System Overview

Metric Ring Terminal, Non-Insulated

Type PM-R

- Brazed seam



Disconnects

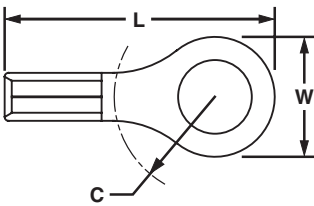

Splices

Part Number	Wire Range	Stud Size	Figure Dimensions (mm)			Crimp Tool	Std. Pkg. Qty.	Std. Ctn. Qty.
			L	W	C			
PM1-3R-C	.5-1.0	M3	15.4	5.9	5.2	CT-1570	100	500
PM1-4R-C		M4	17.9	7.9	6.4		100	500
PM1-5R-C		M5	18.9	8.9	6.4		100	500
PM2-3R-C	1.5-2.5	M3	15.4	5.9	5.1	CT-1570	100	500
PM2-4R-C		M4	17.9	7.9	6.5		100	500
PM2-5R-C		M5	18.4	8.9	6.5		100	500
PM6-3R-L	2.5-6.0	M3	18.8	6.0	7.8	CT-1570	50	250
PM6-4R-L		M4	19.8	8.0	7.8		50	250
PM6-5R-L		M5	20.5	9.5	7.8		50	250
PM6-6R-L		M6	23.1	10.9	9.7		50	250
PM6-6R-L		M6	23.1	10.9	9.7		50	250
PM6-8R-L		M8	24.2	13.3	9.7		50	250

Ferrules

Metric Fork Terminal, Nylon Insulated – Funnel Entry

Type PMNF-F

- Insulation grip sleeve



Compression Connectors

Crimping Tools

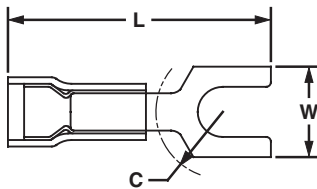

Mechanical Connectors

Part Number	Wire Range	Color Code	Max. Ins.	Stud Size	Figure Dimensions (mm)			Crimp Tool	Std. Pkg. Qty.	Std. Ctn. Qty.
					L	W	C			
PMNF1-3F-C	.5-1.5	Red	3.71	M3	20.0	5.9	4.9	CT-1550	100	500
PMNF1-4F-C				M4	21.3	8.2	5.8		100	500
PMNF1-5F-C				M5	21.8	8.9	6.3		100	500
PMNF1-6F-C				M6	25.8	11.2	8.4		100	500
PMNF2-3F-C	1.5-2.5	Blue	4.11	M3	19.6	5.9	4.9	CT-1550	100	500
PMNF2-4F-C				M4	21.6	7.9	5.8		100	500
PMNF2-5F-C				M5	22.0	8.6	6.4		100	500
PMNF2-6F-C			4.11	M6	26.5	11.2	8.4		100	500
PMNF6-4F-L	2.5-6.0	Yellow	5.94	M4	27.5	7.9	6.2	CT-1550	50	250
PMNF6-5F-L				M5	27.5	9.5	6.2		50	250
PMNF6-6F-L				M6	30.2	11.0	8.2		50	250

Grounding Connectors

Metric Fork Terminal, Vinyl Insulated – Funnel Entry

Type PMV-F

- Insulation support



Support Products

Technical Info

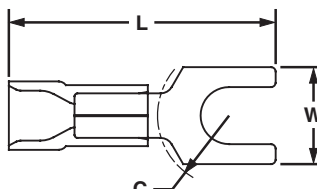

Index

Part Number	Wire Range	Color Code	Max. Ins.	Stud Size	Figure Dimensions (mm)			Crimp Tool	Std. Pkg. Qty.	Std. Ctn. Qty.
					L	W	C			
PMV1-3FB-C	.5-1.5	Red	4.01	M3	21.8	5.9	4.9	CT-1550	100	500
PMV1-4FB-C				M4	23.7	8.2	5.8		100	500
PMV1-5FB-C				M5	23.7	8.9	6.3		100	500
PMV1-6FB-C				M6	28.5	11.2	8.4		100	500
PMV2-3FB-C	1.5-2.5	Blue	4.70	M3	21.6	5.9	4.9	CT-1550	100	500
PMV2-4FB-C				M4	23.0	8.2	5.8		100	500
PMV2-5FB-C				M5	23.3	8.6	6.4		100	500
PMV2-6FB-C				M6	28.2	11.2	8.4		100	500
PMV6-4F-L	2.5-6.0	Yellow	6.10	M4	26.7	7.9	6.2	CT-1550	50	250
PMV6-5F-L				M5	26.7	9.5	6.2		50	250
PMV6-6F-L				M6	29.3	11.0	6.2		50	250

Metric Fork Terminal, Non-Insulated

Type PM-F

- Brazed seam
- Beveled wire lead-in

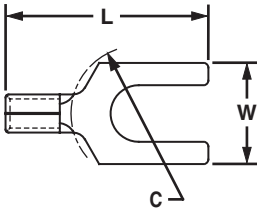

Part Number	Wire Range	Stud Size	Figure Dimensions (mm)			Crimp Tool	Std. Pkg. Qty.	Std. Ctn. Qty.
			L	W	C			
PM1-3F-C	.5-1.5	M3	16.2	5.9	4.9	CT-1570	100	500
PM1-4F-C		M4	17.8	8.2	5.8		100	500
PM1-5F-C		M5	18.3	8.9	6.3		100	500
PM2-3F-C	1.5-2.5	M3	16.2	5.9	4.9	CT-1570	100	500
PM2-4F-C		M4	17.8	7.9	6.0		100	500
PM2-5F-C		M5	18.0	8.6	6.4		100	500
PM6-5F-L	2.5-6.0	M5	19.4	9.5	6.2	CT-1570	50	250
PM6-6F-L		M6	22.7	11.0	8.2		50	250

Metric Pin Terminal, Vinyl Insulated

Type PMV-P

- Funnel entry speeds wire insertion for faster assembly and lower installed costs
- Industry standard color coding to indicate wire range
- Brazed seam assures a reliable crimp
- Insulation support
- For pin-type terminal blocks

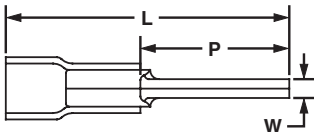

Part Number	Wire Range	Color Code	Max. Ins.	Figure Dimensions (In.)			Crimp Tool	Std. Pkg. Qty.	Std. Ctn. Qty.
				L	W	P			
PMV1-P10-C	.5-1.5	Red	4.06	21.3	2.0	11.9	CT-1550	100	500
PMV2-P10-C	1.5-2.5	Blue	4.44	21.3	2.0	11.9		100	500
PMV6-P10-L	2.5-6.0	Yellow	6.48	28.4	2.7	14.0		50	250

Metric Pin Terminal, Non-Insulated

Type PM-P

- Brazed seam
- Beveled wire lead-in
- For pin type terminal blocks

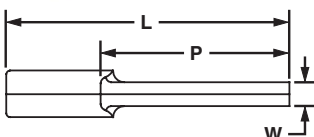

Part Number	Wire Range	Color Code	Max. Ins.	Figure Dimensions (In.)			Crimp Tool	Std. Pkg. Qty.	Std. Ctn. Qty.
				L	W	P			
PM1-P10-C	.5-1.5	—	—	17.5	2.0	11.9	CT-1570	100	500
PM2-P10-C	1.5-2.5	—	—	17.5	2.0	11.9		100	500
PM6-P10-L	2.5-6.0	—	—	20.3	2.7	14.0		50	250

System Overview

Plastic Box Terminal Kits

Terminals



KP-1075

Disconnects



KP-1165

Splices

Ferrules

Compression Connectors

Steel Kit Boxes



K-1102

Crimping Tools

Mechanical Connectors

Grounding Connectors

Support Products

Technical Info

Index

- Ideal for maintenance and construction wiring
- Kit has hanging tab for easy storage
- Rugged plastic construction

Part Number	Part Description	Std. Pkg. Qty.
KP-1075	Terminal kit without crimping tool. Includes the following: (20) PV18-8R; PV18-6F; PV14-8F; PV14-10R; (10) PV10-8R; PV10-10R; DNF14-250; DNF-18-250; BSV18X; BSV14X; BSV10X; (5) JN418-212.	1
KP-1000	Empty plastic box 12 terminal compartments and 1 tool compartment, measures 11" wide x 6 3/4" deep x 1 3/4" high: <ul style="list-style-type: none"> • Positive latch prevents accidental opening • Once top is closed, terminals remain in their compartments 	1
KP-1165	Includes the following: (18) PV18-8R; PV14-10R; P18-6F; P14-8F; (10) PV10-8R; PV10-10R; BSV18X; BSV14X; BSV10X; DV18-250B; DV14-188B; (5) JN418-212; (1) CT-160 Tool; KP-1000 Box.	1
KP-1166	Includes the following: (18) P18-8R; P14-10R; P18-6F; P14-8F; (10) P10-8R; P10-10R; BS18; BS14; BS10; D18-250; D14-188; (5) JN218-216; (1) CT-160 Tool; KP-1000 Box.	1

- Terminal kit in rugged steel case that can be used stand-alone or fits into 2, 4 or 6 drawer slide racks

Part Number	Part Description	Std. Pkg. Qty.
K-1000	Empty steel box, 20 terminal compartments and 1 tool compartment, measures 13 21/64" wide x 9 21/64" deep x 2" high: <ul style="list-style-type: none"> • Latch prevents accidental opening • Handle for portability or as drawer pull when used in rack • Drop-in label area on front 	1
K-1001	Empty steel kit box, 20 terminal compartments and 1 tool compartment, box measures 13 21/64" wide x 9 21/64" deep x 2" high.	1
K-1100	Steel box and CT-100 Crimping Tool.	1
K-1102	Includes the following: (100) PV18-6LF; PV18-8LF; PV14-8LF; PV14-10LF; BSV18X; BSV14X; (50) PV10-10LF; BSV10X; (1) CT-100 Tool; K-1000 Box.	1
K-1103	Includes the following: (100) DV18-250B; DV14-250B; DV14-250MB; D18-250; D14-250; (50) DV10-250; D10-250; (1) CT-100 Tool; K-1000 Box.	1
K-1104	Includes the following: (50) PN18-10R; PN14-6R; PN14-10R; PN18-6F; PN14-6F; PN14-10F; (25) PN10-10R; PN10-56R; PN10-10F; BSN14; BSN10; JN418-212; (1) CT-100 Tool; K-1000 Box.	1

Steel Slide Racks



- Consists of steel boxes, storage slide racks and base, which can be combined for neat, organized storage of terminals
- Rugged and durable steel construction
- Empty boxes, full kits, slide racks and base are purchased according to your application needs

Part Number	Part Description	Std. Pkg. Qty.
SR2	2-drawer slide rack to hold K-1000 series terminal kit.	1
SR4	4-drawer slide rack to hold K-1000 series terminal kit.	1
SR6	6-drawer slide rack to hold K-1000 series terminal kit.	1

Base and slide racks are sold separately.

Slide racks will accommodate the following PANDUIT® kits:	
K-1000	K-1103
K-1001	K-1104
K-1100	K1-PNKIT
K-1102	K2-PVKIT

Industrial Maintenance Kits



K1-PNKIT



K2-PVKIT



K-205

- Steel kits have individual compartments for storage of terminals
- Convenient carrying handle
- Once top is closed, terminals remain in their compartments

Part Number	Part Description	Std. Pkg. Qty.
K1-PNKIT	Kit contains: (1) K-1001 steel kit box; (1) CT-260 installation tool <u>Cable Ties</u> (100) PLT2S cable ties <u>Terminals</u> (100) PN14-610R multistud terminals: (100) PN18-610R multistud terminals (100) PN18-6LF locking fork terminals: (100) PN14-8LF locking fork terminals (50) PN10-10LF locking fork terminals: (100) PN18-8F fork terminals (100) PN14-10R ring terminals: (50) PN10-10R ring terminals <u>Disconnects</u> (100) DNF18-250 disconnects: (100) DNF14-250 disconnects (50) DV10-250 disconnects <u>Splices</u> (50) BSN18 butt splices: (50) BSN14 butt splices: (25) BSN10 butt splices <u>Marking System</u> (1) PMD-0-9 marking dispenser and tape: (100) MP150 marker tags (1) PX-0 marker	1
K2-PVKIT	Kit contains: (1) K-1001 steel kit box; (1) CT-260 installation tool <u>Cable Ties</u> (100) PLT2S cable ties <u>Terminals</u> (100) PV18-8F fork terminals: (100) PV18-6LF locking fork terminals (100) PV14-8LF locking fork terminals: (50) PV10-10LF locking fork terminals (100) PV18-610R multi-stud terminals: (100) PV14-10R ring terminals (50) PV10-10R ring terminals <u>Disconnects</u> (100) DV18-250B disconnects: (100) DV14-250B disconnects (50) DV10-250 disconnects <u>Splices</u> (50) BSV18X butt splices: (50) BSV14X butt splices: (25) BSV10X butt splices <u>Wire Joints</u> (30) JN224-318: (15) JN314-412 <u>Marking System</u> (1) PMD-0-9 marking dispenser and tape	1
K-205*	Kit contains: (1) K-200 steel kit box; (1) GTS cable tie installation tool (1) CT-100 crimping tool <u>Natural Nylon 6.6 Cable Ties</u> (100) PLT1M-C: (100) PLT1.5I-C: (100) PLT2S-C <u>Terminals</u> (100) PV18-6LF-C: (100) PV14-8LF-C: (100) PV14-10LF-C: (50) PV10-10LF-L <u>Splices</u> (50) BSV10X-L: (100) BSV14X-C: (100) BSV18X-C	1

*The K-205 does not fit into the SR2, SR4, or SR6.

System Overview

Terminals

Disconnects

Splices

Ferrules

Compression Connectors

Crimping Tools

Mechanical Connectors

Grounding Connectors

Support Products

Technical Info

Index

System
Overview

NOTES

Terminals

Disconnects

Splices

Ferrules

Compression
Connectors

Crimping
Tools

Mechanical
Connectors

Grounding
Connectors

Support
Products

Technical
Info

Index

PAN-TERM® DISCONNECTS

PANDUIT® PAN-TERM® Disconnects are designed and precision made to function as a reliable method of making quick, repeatable interconnections. Available with nylon, premium nylon or vinyl insulation or non-insulated.



- Fully insulated design provides excellent protection from electrical shorts and provides additional installer protection for safety from electrical shocks
- Funnel entry speeds insertion and minimizes turned back wire strands
- Integrated metal insulation grip provides double crimp insulation grip for high vibration or conductor strain environments on select SUPRA-GRIP™ disconnects and DISCO-LOK™ disconnects and DISCO-GRIP™ disconnects
- Applicable sizes are UL Listed and CSA Certified, as noted
- Wide assortment of manual, controlled cycle, battery operated hydraulic and pneumatic crimping tools for reliable connections at the lowest installed cost

PANDUIT® continually provides new designs to meet the application challenges encountered by our customers. PANDUIT® offers a wide assortment of PAN-TERM® termination products at the lowest installed cost.

System Overview

Terminals

Disconnects

Splices

Ferrules

Compression Connectors

Crimping Tools

Mechanical Connectors

Grounding Connectors

Support Products

Technical Info

Index

System Overview

Features and Benefits — PAN-TERM® Disconnects

PAN-TERM® disconnects are fabricated from brass and are electro-tin plated for a long, corrosion resistant operating life.

Terminals

Disconnects

Splices

Ferrules

Compression Connectors

Crimping Tools

Mechanical Connectors

Grounding Connectors

Support Products

Technical Info

Index

Nylon Fully Insulated Female Receptacles and Male Tabs Type DNF-FIB

Available in tab sizes to accommodate .110", .187", .205" or .250" tabs

Fully insulated design provides protection from electrical shorts

Expanded wire entry (on select sizes) accommodates large insulation or multiple wires

Maximum insulation temperature 125°C (257°F)

Insulation support restricts excessive wire movement to minimize stress on crimp joint

Funnel entry for faster wire insertion and lower installed cost

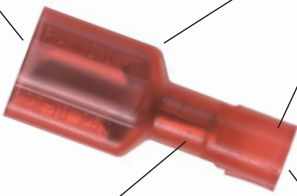

*UL and CSA rated up to 600V per UL310.

DISCO-GRIP™ Premium Nylon Fully Insulated Female Receptacles and Male Tabs Type DNF and DPF

Available in tab sizes to accommodate .110", .187", .205" or .250" tabs

Fully insulated design provides protection from electrical shorts

Maximum insulation temperature 105°C (221°F)

Funnel entry for faster wire insertion and lower installed cost

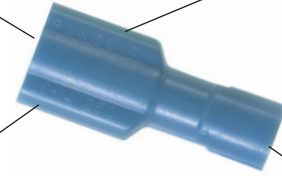

*UL and CSA rated up to 600V per UL310.

**Male products available .250" width in standard and oversized housing configurations.

SUPRA-GRIP™ Nylon Fully Insulated Female Disconnects Type DNG-FB

Available in tab sizes to accommodate .187" or .250" tabs

Fully insulated design provides protection from electrical shorts

Maximum insulation temperature 105°C (221°F)

Fully integrated metal insulation grip for high vibration, high strain relief, and double crimp requirements

Funnel entry for faster wire insertion and lower installed cost



*UL and CSA rated up to 600V per UL310.

DISCO-LOK™ Nylon Fully Insulated Locking Female Disconnects Type DNG-FL

Available in tab sizes to accommodate 250" tabs

Unique locking mechanism allows for low insertion forces (mating) and positive locking for secure connections

Maximum insulation temperature 105°C (221°F)

Insulation grip sleeve provides a superior insulation crimp for high vibration and high strain relief applications

Funnel entry for faster wire insertion and lower installed cost

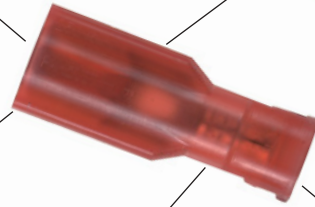

*UL and CSA rated up to 300V.

Features and Benefits — PAN-TERM® Disconnects (continued)

Nylon Barrel Insulated Female Receptacles and Male Tabs Type DNF

Available in tab sizes to accommodate .110", .187", .205" or .250" tabs

Maximum insulation temperature 105°C (221°F)

Insulation grip sleeve provides a superior insulation crimp for high vibration and high strain relief applications

Funnel entry for faster wire insertion and lower installed cost



*UL and CSA rated up to 300V.
**Male products available .250" width.

Vinyl Barrel Insulated Female Receptacles and Male Tabs Type DV and DVF

Available in tab sizes to accommodate .187", .205" or .250" tabs

Maximum insulation temperature 105°C (221°F)

Insulation grip sleeve provides a superior insulation crimp for high vibration and high strain relief applications

Insulation support to protect electrical crimp



*UL and CSA rated up to 600V.
**Male products available .250" width.
***Flammability – UL94V-0.

Non-Insulated Female Receptacles and Male Tabs Type D

Available in tab sizes to accommodate .187" or .250" tabs

Maximum recommended operating temperature 150°C (302°F)

Sleeved barrel assures crimp reliability



*Male products available .250" width.

System Overview

Terminals

Disconnects

Splices

Ferrules

Compression Connectors

Crimping Tools

Mechanical Connectors

Grounding Connectors

Support Products

Technical Info

Index

System Overview

Selection Guide — PAN-TERM® Disconnects

Terminals

Disconnects

Splices

Ferrules

Compression Connectors

Crimping Tools

Mechanical Connectors

Grounding Connectors

Support Products

Technical Info

Index

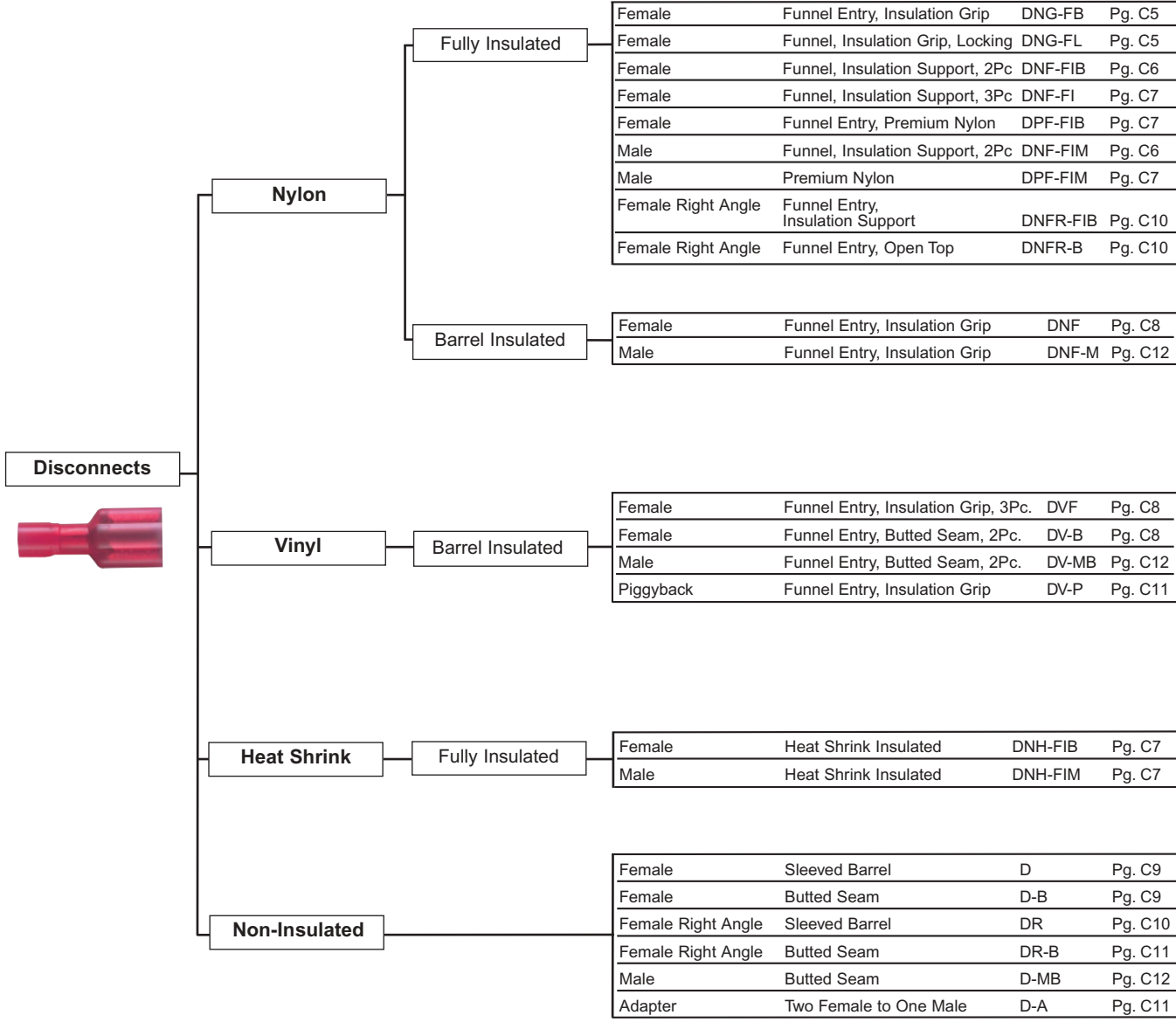

Performance Requirements

	Wire Size (AWG)						
	#22	#20	#18	#16	*#14	#12	#10
UL310 (DISCONNECTS)							
Continuous Test Current for Max. 30°C Rise (amps) (for 187", 205", 250" tab widths)	3	4	7	10	15	20	24
Continuous Test Current for Max. 30°C Rise (amps) (for .110", tab width)	2	3	4	5	Not Applicable		
Min. Tensile Strength* (Lbs.)	8	13	20	30	50	70	80

*Pull-out force of the crimped disconnect.

Applicable PAN-TERM® products meet or exceed the following test specifications:

- UL310 (Disconnects)
- CSA C22.2 No. 153 (all designs)

UL and CSA Listed products are shown with the applicable logos in the product section.

UL file #E78522 and CSA file #LR31212.

Part Number System for PAN-TERM® Disconnects

D	NF	—	14	250	FIB	—	M
Type	Insulation		Wire Range	Tab Size	Special Configuration		Std. Pkg. Size
D = Disconnects	N = Nylon		18 = #22-18	110 = .110 x .032	A = Adapter		L = 50
	NF = Nylon, Funnel Entry		14 = #16-14	111 = .110 x .020	B = Butted Seam		C = 100
	NFR = Nylon, Funnel Entry, Right Angle		10 = #12-10	145 = .145 x .032	FB = Metal Insulation Grip, Female		D = 500
				187 = .187 x .032	FI = Fully Insulated, Female		M = 1000
				188 = .187 x .020			
	NG = Nylon, Funnel Entry, Metal Insulation Grip			205 = .187/.205 x .032	FIB = Fully Insulated, Butted Seam, Female		
				206 = .187/.205 x .020	FIM = Fully Insulated, Male		
	PF = Premium Grade Nylon, Funnel Entry			250 = .250 x .032	FIMB = Fully Insulated, Male with Oversized Housing		
	R = Non-Insulated, Right Angle				FL = Locking, Metal Insulation Grip, Female		
	V = Vinyl				M = Male		
	= Non-Insulated (leave blank)				= Female (leave blank)		
					P = Piggyback		

UL LISTED SP® SUPRA-GRIP™ Female Disconnect, Nylon Fully Pre-Insulated

Type DNG-FB

- Funnel entry
- Integrated metal insulation grip to meet double crimp requirements
- Color coded insulation
- Internal wire barrel serrations for maximum wire tensile strength
- Tab size clearly marked on insulation housing
- Tin plated brass stamping
- Internal wire stop
- Mates with DNF-250FIMB

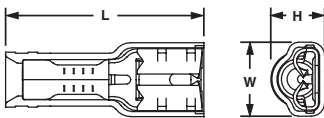

Part Number	Wire Range	Color Code	Max. Ins.	Figure Dimensions (In.)			Tab Size	Crimp Tool	Std. Pkg. Qty.**	Std. Ctn. Qty.
				L	W	H				
DNG18-187FB-C	22-18 AWG	Red	.128	.89	.29	.22	.187 x .032	CT-1015	100	1000
DNG18-188FB-C			.128	.89	.29	.22	.187 x .020		100	1000
DNG18-250FB-C			.126	.93	.35	.22	.250 x .032		100	1000
DNG14-187FB-C	16-14 AWG	Blue	.128	.89	.29	.22	.187 x .032	CT-1015	100	1000
DNG14-188FB-C			.128	.89	.29	.25	.187 x .020		100	1000
DNG14-250FB-C			.153	.93	.35	.25	.250 x .032		100	1000

**To order in bulk, replace -C in the part number with -M for a bulk package of 1000.

UL LISTED SP® Disco-Lok™ Female Disconnect, Nylon Fully Pre-Insulated

Type DNG-FL

- Positive locking mechanism design allows for low insertion force (mating) and locking withdrawal force (separation)
- Fully pre-insulated (color coded)
- Integrated funnel entry
- Insulation grip
- Tab size markings
- Tin plated brass stamping

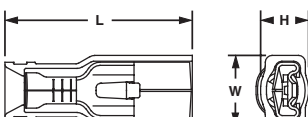

Part Number	Wire Range	Color Code	Max. Ins.	Figure Dimensions (In.)			Tab Size	Crimp Tool	Std. Pkg. Qty.**	Std. Ctn. Qty.
				L	W	H				
DNG18-250FL-C	22-18 AWG	Red	.126	.97	.36	.24	.250 x .032	CT-1014	100	1000
DNG14-250FL-C	16-14 AWG	Blue	.150	.97	.36	.25	.250 x .032	CT-1014	100	1000

**To order in bulk, replace -C in the part number with -M for a bulk package of 1000.

System Overview



Male/Female Couplers Nylon Fully Pre-Insulated – Funnel Entry

Type DNF

- Insulation support
- Internal wire stop

Terminals



Disconnects



Splices

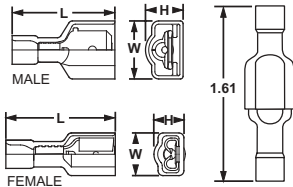

Ferrules

Part Number	Wire Range	Color Code	Max. Ins.	Figure Dimensions (In.)			Type	Tab Size	Crimp Tool	Std. Pkg. Qty.**	Std. Ctn. Qty.
				L	W	H					
DNF18-250FIM-C	22-18 AWG	Red	.136	.90	.42	.27	Male	.250 x .032	CT-600, CT-1525	100	1000
DNF18-250FIMB-L*			.136	.91	.45	.35	Male	.250 x .032		50	500
DNF18-250FIB-C			.136	.84	.35	.22	Female	.250 x .032	CT-100, CT-600, CT-1525	100	1000
DNF14-250FIM-C	16-14 AWG	Blue	.160	.90	.42	.27	Male	.250 x .032	CT-600, CT-1525	100	1000
DNF14-250FIMB-L			.160	.91	.45	.35	Male	.250 x .032		50	500
DNF14-250FIB-C			.160	.84	.35	.22	Female	.250 x .032	CT-100, CT-600, CT-1525	100	1000
DNF10-250FIMB-L	12-10 AWG	Yellow	.220	.96	.45	.36	Male	.250 x .032	CT-600, CT-1550, CT-1551	50	500
DNF10-250FI-L			.230	.95	.36	.27	Female	.250 x .032		CT-100, CT-460, CT-600, CT-1550, CT-1551	50

*Oversized housing design will mate with receptacles up to .390" wide and .235" high (.285" high for parts with orientation bump).

**To order in bulk, replace -C in the part number with -M for a bulk package of 1000 and replace -L with -D for a bulk package of 500.

◆DNF10-250FIMB is UL Listed only.

Compression Connectors

Crimping Tools



Female Disconnect, Nylon Fully Pre-Insulated – Funnel Entry

Type DNF-FIB

- Insulation support
- Internal wire stop

Mechanical Connectors



Grounding Connectors



Support Products

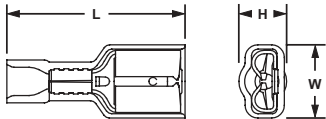

Part Number	Wire Range	Color Code	Max. Ins.	Figure Dimensions (In.)			Tab Size	Crimp Tool	Std. Pkg. Qty.**	Std. Ctn. Qty.			
				L	W	H							
DNF18-110FIB-C	22-18 AWG	Red	.136	.71	.19	.16	.110 x .032	CT-100, CT-600, CT-1525	100	1000			
DNF18-111FIB-C			.136	.71	.19	.16	.110 x .020		100	1000			
DNF18-187FIB-C			.136	.78	.29	.16	.187 x .032		100	1000			
DNF18-188FIB-C			.136	.78	.29	.16	.187 x .020		100	1000			
DNF18-205FIB-C			.136	.78	.31	.22	.205 x .032		100	1000			
DNF18-206FIB-C			.136	.78	.31	.22	.205 x .020		100	1000			
DNF18-250FIB-C			.136	.84	.35	.22	.250 x .032		100	1000			
DNF14-187FIB-C			16-14 AWG	Blue	.160	.78	.29		.18	.187 x .032	CT-100, CT-600, CT-1525	100	1000
DNF14-188FIB-C					.160	.78	.29		.18	.187 x .020		100	1000
DNF14-205FIB-C	.160	.78			.31	.22	.205 x .032	100	1000				
DNF14-206FIB-C	.160	.78			.31	.22	.205 x .020	100	1000				
DNF14-250FIB-C	12-10 AWG	Yellow	.160	.84	.35	.22	.250 x .032	CT-1525	100	1000			
DNF10-250FIB-L			.220	.96	.36	.23	.250 x .032		50	500			

**To order in bulk, replace -C in the part number with -M for a bulk package of 1000 and replace -L with -D for a bulk package of 500.

Technical Info

Index



Female Disconnect, Nylon Fully Pre-Insulated – Funnel Entry

Type DNF-FI

- Insulation support
- Metal sleeve
- Internal wire stop

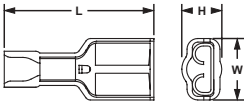

Part Number	Wire Range	Color Code	Max. Ins.	Figure Dimensions (In.)			Tab Size	Crimp Tool	Std. Pkg. Qty.**	Std. Ctn. Qty.
				L	W	H				
DNF18-250FI-C	22-18 AWG	Red	.136	.84	.35	.21	.250 x .032	CT-100, CT-600, CT-1551	100	1000
DNF14-250FI-C	16-14 AWG	Blue	.160	.84	.35	.24	.250 x .032	CT-1550, CT-1551	100	1000
DNF10-250FI-L	12-10 AWG	Yellow	.230	.95	.36	.27	.250 x .032	CT-100, CT-460, CT-600, CT-1550, CT-1551	50	500

**To order in bulk, replace -C in the part number with -M for a bulk package of 1000 and replace -L with -D for a bulk package of 500.



DISCOGRIP™ Male Disconnect, Premium Nylon Fully Pre-Insulated – Funnel Entry

Type DPF-FIM

- Insulation grip
- Internal wire stop

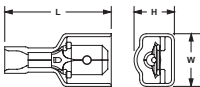
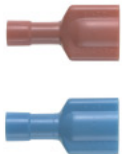

Part Number	Wire Range	Color Code	Max. Ins.	Figure Dimensions (In.)			Tab Size	Crimp Tool	Std. Pkg. Qty.**	Std. Ctn. Qty.
				L	W	H				
DPF18-250FIM-C	22-18 AWG	Red	.133	.90	.41	.29	.250 x .032	CT-600, CT-1525	100	1000
DPF14-250FIM-C	16-14 AWG	Blue	.156	.90	.41	.29	.250 x .032		100	1000
DPF18-250FIMB-L*	22-18 AWG	Red	.133	.92	.46	.34	.250 x .032		50	500
DPF14-250FIMB-L*	16-14 AWG	Blue	.156	.92	.46	.34	.250 x .032		50	500

*Oversized housing design will mate with receptacles up to .390" wide and .235" (.285" high for parts with orientation bump).

**To order in bulk, replace -C in the part number with -M for a bulk package of 1000 and replace -L with -D for a bulk package of 500.



DISCOGRIP™ Female Disconnect, Premium Nylon Fully Insulated – Funnel Entry

Type DPF-FIB

- Insulation grip
- Internal wire stop

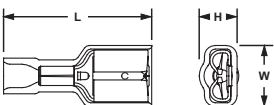

Part Number	Wire Range	Color Code	Max. Ins.	Figure Dimensions (In.)			Tab Size	Crimp Tool	Std. Pkg. Qty.**	Std. Ctn. Qty.
				L	W	H				
DPF18-110FIB-C	22-18 AWG	Red	.133	.71	.19	.16	.110 x .032	CT-600‡, CT-1525‡	100	1000
DPF18-111FIB-C			.133	.71	.19	.16	.110 x .020		100	1000
DPF18-205FIB-C			.133	.78	.31	.22	.205/.187 x .032		100	1000
DPF18-206FIB-C			.133	.78	.31	.22	.205/.187 x .020		100	1000
DPF18-250FIB-C			.133	.84	.35	.22	.250 x .032		100	1000
DPF14-205FIB-C	16-14 AWG	Blue	.156	.78	.31	.22	.205/.187 x .032	CT-600‡, CT-1525‡	100	1000
DPF14-206FIB-C			.156	.78	.31	.22	.205/.187 x .020		100	1000
DPF14-250FIB-C			.156	.84	.35	.22	.250 x .032		100	1000
DPF10-250FI-L	12-10 AWG	Yellow	.218	.95	.36	.27	.250 x .032	CT-460‡, CT-600‡, CT-1525‡, CT-1551	50	500
DPF10-250FIB-L			.218	.95	.36	.23	.250 x .032		50	500

‡UL and CSA approved tooling/product combinations.

**To order in bulk, replace -C in the part number with -M for a bulk package of 1000 and replace -L with -D for a bulk package of 500.

Heat Shrink Disconnects, Fully Pre-Insulated – Funnel Entry

Type DNH

- Heat shrink polyolefin with hot melt sealant
- Adhesive lined heat shrink
- Brazed seam

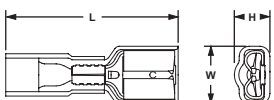

Part Number	Wire Range	Color Code	Max. Ins.	Figure Dimensions (In.)			Type	Wire Strip Length	Crimp Tool	Std. Pkg. Qty.	Std. Ctn. Qty.
				L	W	H					
DNH18-250FIM-Q	22-18 AWG	Red	.133	1.50	.41	.31	Male	5/16	CT-310	25	125
DNH18-250FIB-Q			.132	1.44	.35	.22	Female			25	125
DNH14-250FIM-Q	16-14 AWG	Blue	.158	1.50	.41	.31	Male			25	125
DNH14-250FIB-Q			.156	1.44	.35	.22	Female			25	125
DNH10-250FI-E	12-10 AWG	Yellow	.230	1.44	.35	.27	Female			20	100

System Overview



Female Disconnect, Nylon Barrel Insulated – Funnel Entry

Type DNF

- Insulation grip sleeve

Terminals



Disconnects

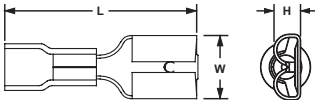

Splices

Part Number	Wire Range	Color Code	Max. Ins.	Figure Dimensions (In.)			Tab Size	Crimp Tool	Std. Pkg. Qty.**	Std. Ctn. Qty.
				L	W	H				
DNF18-110-C	22-18 AWG	Red	.100	.69	.15	.08	.110 x .032	CT-600‡, CT-1525‡	100	500
DNF18-111-C			.100	.69	.15	.07	.110 x .020		100	500
DNF18-187-C			.137	.76	.23	.10	.187 x .032		100	500
DNF18-188-C			.137	.76	.23	.10	.187 x .020		100	500
DNF18-205-C			.137	.76	.25	.12	.205/.187 x .032		100	500
DNF18-206-C			.137	.76	.25	.12	.205/.187 x .020		100	500
DNF18-250-C	16-14 AWG	Blue	.138	.81	.29	.12	.250 x .032	CT-1525	100	500
DNF14-110-C*			.162	.75	.15	.08	.110 x .032		100	500
DNF14-111-C*			.162	.75	.15	.07	.110 x .020	100	500	
DNF14-187-C			.162	.76	.23	.10	.187 x .032	100	500	
DNF14-188-C			.162	.76	.23	.10	.187 x .020	CT-600‡, CT-1550, CT-1551	100	500
DNF14-205-C			.162	.76	.25	.12	.205/.187 x .032	100	500	
DNF14-206-C			.162	.76	.25	.12	.205/.187 x .020	100	500	
DNF14-250-C			.162	.83	.29	.12	.250 x .032	100	500	

‡UL and CSA approved tooling/product combinations.

*Not UL Listed or CSA Certified.

**To order in bulk, replace -C in the part number with -M for a bulk package of 1000.

Ferrules



Female Disconnect, Vinyl Barrel Insulated – Funnel Entry

Type DVF

- Insulation grip sleeve

Compression Connectors



Crimping Tools

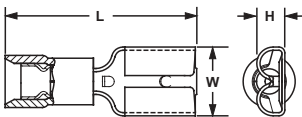

Mechanical Connectors

Part Number	Wire Range	Color Code	Max. Ins.	Figure Dimensions (In.)			Tab Size	Crimp Tool	Std. Pkg. Qty.**	Std. Ctn. Qty.
				L	W	H				
DVF18-187-C	22-18 AWG	Red	.137	.76	.23	.10	.187 x .032	CT-1550‡, CT-1551‡	100	500
DVF18-188-C			.137	.76	.23	.10	.187 x .020		100	500
DVF18-205-C			.137	.76	.25	.12	.205 x .032		100	500
DVF18-206-C			.137	.76	.25	.12	.205 x .020		100	500
DVF18-250-C			.137	.81	.29	.12	.250 x .032		100	500
DVF14-187-C			16-14 AWG	Blue	.162	.76	.23		.10	.187 x .032
DVF14-188-C	.162	.76			.23	.10	.187 x .020	100	500	
DVF14-205-C	.162	.76			.25	.12	.205 x .032	100	500	
DVF14-206-C	.162	.76			.25	.12	.205 x .020	100	500	
DVF14-250-C	.162	.81			.29	.12	.250 x .032	100	500	

‡UL and CSA approved tooling/product combinations.

**To order in bulk, replace -C in the part number with -M for a bulk package of 1000.

Grounding Connectors



Female Disconnect, Vinyl Barrel Insulated – Butted Seam

Type DV-B

- Butted seam

Support Products



Technical Info

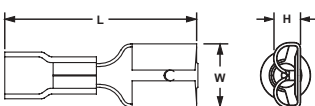

Part Number	Wire Range	Color Code	Max. Ins.	Figure Dimensions (In.)			Tab Size	Crimp Tool	Std. Pkg. Qty.**	Std. Ctn. Qty.
				L	W	H				
DV18-187B-C	22-18 AWG	Red	.150	.75	.23	.10	.187 x .032	CT-1525‡	100	500
DV18-188B-C			.150	.79	.23	.10	.187 x .020		100	500
DV18-205B-C			.150	.75	.23	.12	.205 x .032		100	500
DV18-206B-C			.150	.75	.23	.12	.205 x .020		100	500
DV18-250B-C			.150	.81	.29	.12	.250 x .032		100	500
DV14-187B-C			16-14 AWG	Blue	.175	.75	.23		.10	.187 x .032
DV14-188B-C	.175	.79			.23	.10	.187 x .020	100	500	
DV14-205B-C	.170	.75			.23	.12	.205 x .032	100	500	
DV14-206B-C	.170	.75			.23	.12	.205 x .020	100	500	
DV14-250B-C	.170	.81			.29	.12	.250 x .032	100	500	
DV10-250-L*	12-10 AWG	Yellow			.229	1.03	.30	.13	.250 x .032	CT-1550^, CT-1551^

*Sleeved Barrel.

‡UL and CSA approved tooling/product combinations.

^ CSA approved tooling/product combinations.

**To order in bulk, replace -C in the part number with -M for a bulk package of 1000.

Index



Female Disconnect, Non-Insulated – Metal Sleeve

Type D

- Sleeved barrel

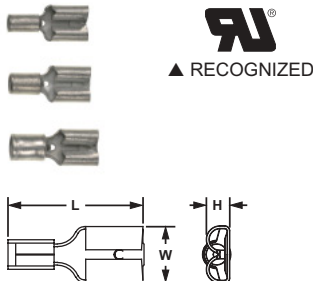

Part Number	Wire Range	Figure Dimensions (In.)			Tab Size	Crimp Tool	Std. Pkg. Qty.**	Std. Ctn. Qty.
		L	W	H				
D18-187-C	22-18 AWG	.58	.23	.10	.187 x .032	CT-100‡	100	500
D18-188-C		.58	.23	.10	.187 x .020	CT-200‡	100	500
D18-250-C		.66	.30	.12	.250 x .032	CT-1570‡	100	500
D14-187-C	16-14 AWG	.58	.23	.10	.187 x .032	CT-100, CT-200, CT-600, CT-1570‡	100	500
D14-188-C		.58	.23	.10	.187 x .020		100	500
D14-250-C		.66	.30	.12	.250 x .032		100	500
D10-250-L	12-10 AWG	.72	.30	.12	.250 x .032	CT-600‡, CT1570‡	50	500

‡UL and CSA approved tooling/product combinations.

**To order in bulk, replace -C in the part number with -M for a bulk package of 1000 and replace -L with -D for a bulk package of 500.

Female Disconnect, Non-Insulated – Butted Seam

Type D-B

- Butted seam

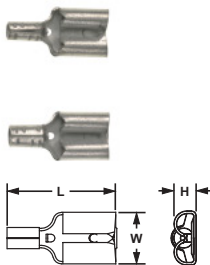

Part Number	Wire Range	Figure Dimensions (In.)			Tab Size	Crimp Tool	Std. Pkg. Qty.**	Std. Ctn. Qty.
		L	W	H				
D18-188B-C	22-18 AWG	.56	.23	.10	.187 x .020	CT-100	100	500
D18-250B-C		.63	.30	.12	.250 x .032		100	500
D14-188B-C	16-14 AWG	.56	.23	.10	.187 x .020	CT-100	100	500
D14-250B-C		.63	.30	.12	.250 x .032		100	500

**To order in bulk, replace -C in the part number with -M for a bulk package of 1000.

Pin Terminal, Vinyl Insulated – Funnel Entry

Type PV-P

- Insulation support
- Brazed seam
- For pin-type terminal blocks

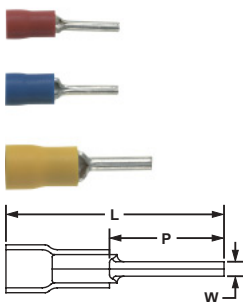

Part Number	Wire Range	Color Code	Max. Ins.	Figure Dimensions (In.)			Crimp Tool	Std. Pkg. Qty.**	Std. Ctn. Qty.
				L	W	P			
PV18-P47-C	22-18 AWG	Red	.150	.98	.07	.49	CT-100, CT-260, CT-1550, CT-1551	100	1000
PV14-P47-C	16-14 AWG	Blue	.170	.98	.07	.49		100	1000
PV10-P55-L	12-10 AWG	Yellow	.250	1.10	.11	.55		50	500

**To order in bulk, replace -C in the part number with -M for a bulk package of 1000 and replace -L with -D for a bulk package of 500.

Pin Terminal, Non-Insulated

Type P-P

- Brazed seam
- Beveled wire lead-in
- For pin-type terminal blocks

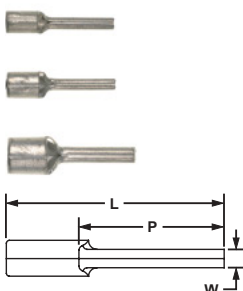

Part Number	Wire Range	Color Code	Max. Ins.	Figure Dimensions (In.)			Crimp Tool	Std. Pkg. Qty.**	Std. Ctn. Qty.
				L	W	P			
P18-P47-C	22-18 AWG	—	—	.75	.07	.49	CT-100, CT-200, CT-260, CT-1570	100	1000
P14-P47-C	16-14 AWG	—	—	.75	.07	.49		100	1000
P10-P55-L	12-10 AWG	—	—	.79	.11	.55		50	500

**To order in bulk, replace -C in the part number with -M for a bulk package of 1000 and replace -L with -D for a bulk package of 500.

System Overview

Terminals

Disconnects

Splices

Ferrules

Compression Connectors

Crimping Tools

Mechanical Connectors

Grounding Connectors

Support Products

Technical Info

Index

System Overview



Right Angle Female Disconnect, Nylon Fully Insulated – Funnel Entry

Type DNFR-FIB

- Insulation support
- Used in limited space applications

Terminals



Disconnects



Splices

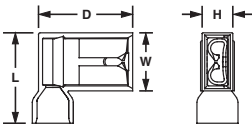

Part Number	Wire Range	Color Code	Max. Ins.	Figure Dimensions (In.)				Tab Size	Crimp Tool	Std. Pkg. Qty.**	Std. Ctn. Qty.
				L	W	H	D				
DNFR18-205FIB-C	22-18 AWG	Red	.178	.58	.21	.21	.60	.205/ .187 x .032	CT-300-1	100	1000
DNFR18-206FIB-C			.178	.58	.21	.21	.60	.205/ .187 x .020			
DNFR18-250FIB-C			.178	.58	.21	.21	.60	.250 x .032			
DNFR14-205FIB-C	16-14 AWG	Blue	.178	.58	.21	.21	.60	.205/ .187 x .032	CT-300-1	100	1000
DNFR14-206FIB-C			.178	.58	.21	.21	.60	.205/ .187 x .020			
DNFR14-250FIB-C			.178	.58	.21	.21	.60	.250 x .032			

**To order in bulk, replace -C in the part number with -M for a bulk package of 1000.

Ferrules



Right Angle Female Disconnect, Nylon Insulated – Funnel Entry

Type DNFR-B

- Insulation support

Compression Connectors



Crimping Tools

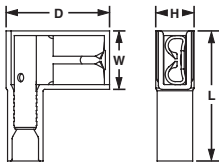
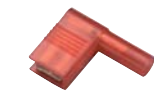

Part Number	Wire Range	Color Code	Max. Ins.	Figure Dimensions (In.)				Tab Size	Crimp Tool	Std. Pkg. Qty.**	Std. Ctn. Qty.
				L	W	H	D				
DNFR18-205B-C	22-18 AWG	Red	.130	.78	.36	.20	.62	.205/ .187 x .032	CT-1525‡	100	1000
DNFR18-206B-C			.130	.78	.36	.20	.62	.205/ .187 x .020			
DNFR18-250B-C			.130	.78	.36	.20	.62	.250 x .032			
DNFR14-205B-C	16-14 AWG	Blue	.155	.78	.36	.20	.63	.205/ .187 x .032	CT-1525‡	100	1000
DNFR14-206B-C			.155	.78	.36	.20	.63	.205/ .187 x .020			
DNFR14-250B-C			.155	.78	.36	.20	.63	.250 x .032			

‡UL and CSA approved tooling/product combinations.

**To order in bulk, replace -C in the part number with -M for a bulk package of 1000.

Mechanical Connectors

Grounding Connectors



Right Angle Female Disconnect, Non-Insulated – Metal Sleeve

Type DR

- Sleeved barrel

Support Products



Technical Info



Part Number	Wire Range	Figure Dimensions (In.)				Tab Size	Crimp Tool	Std. Pkg. Qty.**	Std. Ctn. Qty.
		L	W	H	D				
DR18-205-C	22-18 AWG	.54	.25	.11	.53	.205/ .187 x .032	CT-100‡, CT-200‡, CT-600‡, CT1570‡	100	1000
DR18-206-C		.54	.25	.11	.53	.205/ .187 x .020			
DR18-250-C		.57	.30	.12	.54	.250 x .032			
DR14-205-C	16-14 AWG	.54	.25	.11	.55	.205/ .187 x .032	CT-100‡, CT-200‡, CT-600‡, CT1570‡	100	1000
DR14-206-C		.54	.25	.11	.55	.205/ .187 x .020			
DR14-250-C		.57	.30	.12	.55	.250 x .032			
DR10-250-L	12-10 AWG	.61	.30	.12	.57	.250 x .032		50	500

‡UL and CSA approved tooling/product combinations.

**To order in bulk, replace -C in the part number with -M for a bulk package of 1000 and replace -L with -D for a bulk package of 500.

Index

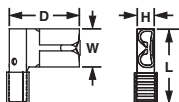



Right Angle Female Disconnect, Non-Insulated

Type DR-B

- Butted seam

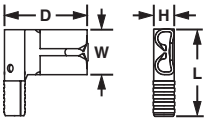

Part Number	Wire Range	Figure Dimensions (In.)				Tab Size	Crimp Tool	Std. Pkg. Qty.**	Std. Ctn. Qty.
		L	W	H	D				
DR18-205B-C	22-18 AWG	.54	.25	.12	.53	.205/.187 x .032	CT-100, CT-200, CT-1570	100	1000
DR18-206B-C		.54	.25	.12	.53	.205/.187 x .020		100	1000
DR18-250B-C		.55	.30	.12	.53	.250 x .032		100	1000
DR14-205B-C	16-14 AWG	.54	.25	.12	.55	.205/.187 x .032	CT-100, CT-200, CT-1570	100	1000
DR14-206B-C		.54	.25	.12	.55	.205/.187 x .020		100	1000
DR14-250B-C		.55	.30	.12	.55	.250 x .032		100	1000

*CSA Certified only.

**To order in bulk, replace -C in the part number with -M for a bulk package of 1000.

Piggyback Disconnect, Vinyl Insulated

Type DV-P

- Insulation grip sleeve
- Female and male tabs combined in one disconnect
- Allows additional circuits to be added to existing equipment or ability to add future circuits — no costly rework or product changes needed

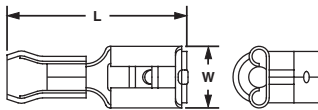

Part Number	Wire Range	Color Code	Max. Ins.	Figure Dimensions (In.)		Tab Size	Crimp Tool	Std. Pkg. Qty.**	Std. Ctn. Qty.
				L	W				
DV18-250P-C	22-18 AWG	Red	.130	.88	.29	.250 x .032	CT-100, CT-260, CT-1550, CT-1551	100	1000
DV14-250P-C	16-14 AWG	Blue	.160	.88	.29	.250 x .032		100	1000

**To order in bulk, replace -C in the part number with -M for a bulk package of 1000.

Disconnect Adapter, Non-Insulated

Type D-A

- Couples two female disconnects to one male disconnect (all .250 x .032)

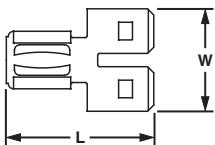

Part Number	Wire Range	Color Code	Max. Ins.	Figure Dimensions (In.)		Tab Size	Std. Pkg. Qty.**	Std. Ctn. Qty.
				L	W			
D-250A-C	—	—	—	.82	.57	.250 x .032	100	1000

**To order in bulk, replace -C in the part number with -M for a bulk package of 1000.

System Overview

Terminals

Disconnects

Splices

Ferrules

Compression Connectors

Crimping Tools

Mechanical Connectors

Grounding Connectors

Support Products

Technical Info

Index

System Overview



Male Disconnect, Nylon Barrel Insulated – Funnel Entry

Type DNF-M

- Insulation grip sleeve



Part Number	Wire Range	Color Code	Max. Ins.	Figure Dimension (In.)		Crimp Tool	Std. Pkg. Qty.**	Std. Ctn. Qty.
				L	Tab Size			
DNF18-250M-C	22-18 AWG	Red	.136	.90	.250 x .032	CT-1550, CT-1551	100	1000
DNF14-250M-C	16-14 AWG	Blue	.162	.90	.250 x .032		100	1000
DNF10-250M-L*	12-10 AWG	Yellow	.225	.95	.250 x .032		50	500

*Not CSA Certified.

**To order in bulk, replace -C in the part number with -M for a bulk package of 1000 and replace -L with -D for a bulk package of 500.

Terminals

Disconnects

Splices

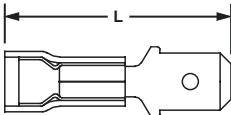

Ferrules



Male Disconnect, Vinyl Barrel Insulated – Funnel Entry

Type DV-MB

- Butted seam



Part Number	Wire Range	Color Code	Max. Ins.	Figure Dimension (In.)		Crimp Tool	Std. Pkg. Qty.**	Std. Ctn. Qty.
				L	Tab Size			
DV18-250MB-C	22-18 AWG	Red	.154	.98	.250 x .032	CT-1550, CT-1551	100	500
DV14-250MB-C	16-14 AWG	Blue	.180	.96	.250 x .032		100	500
DV10-250M-L*	12-10 AWG	Yellow	.235	.98	.250 x .032		50	500

* Not CSA Certified.

**To order in bulk, replace -C in the part number with -M for a bulk package of 1000 and replace -L with -D for a bulk package of 500.

Compression Connectors

Crimping Tools

Mechanical Connectors

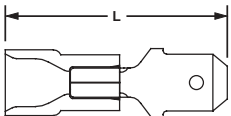

Grounding Connectors

Male Disconnect, Non-Insulated – Butted Seam

Type D-MB



Part Number	Wire Range	Figure Dimension (In.)		Crimp Tool	Std. Pkg. Qty.**	Std. Ctn. Qty.
		L	Tab Size			
D18-250MB-C	22-18 AWG	.69	.250 x .032	CT-100	100	500
D14-250MB-C	16-14 AWG	.69	.250 x .032		100	500
◆ D10-250M-L	12-10 AWG	.72	.250 x .032	CT-100, CT-200, CT-260, CT-1570, CT-600	50	500

**To order in bulk, replace -C in the part number with -M for a bulk package of 1000 and replace -L with -D for a bulk package of 500.

◆ Brazed seam.

Technical Info

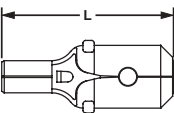

Index

Selection Guide — Specialty Terminals

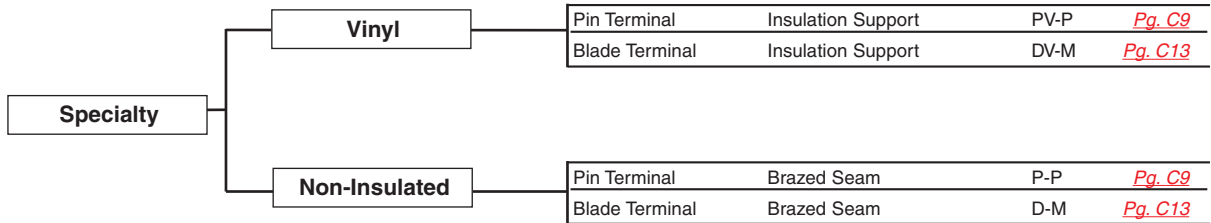

Male Blade Adapter, Vinyl Insulated – Funnel Entry

Type DV-M

- Brazed seam
- For blade-type terminal blocks
- Insulation support

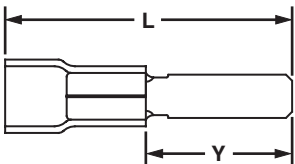

Part Number	Wire Range	Color Code	Max. Ins.	Figure Dimensions (In.)		Tab Size	Crimp Tool	Std. Pkg. Qty.**	Std. Ctn. Qty.
				L	Y				
DV18-145M-C	22-18 AWG	Red	.140	.97	.42	.145 x .032	CT-600, CT-1550‡, CT-1551‡	100	500
DV14-145M-C	16-14 AWG	Blue	.170	.97	.42	.145 x .032		100	500

‡UL and CSA approved tooling/product combinations.

**To order in bulk, replace -C in the part number with -M for a bulk package of 1000.

Male Blade Adapter, Non-Insulated

Type D-M

- Brazed seam
- For blade-type terminal blocks

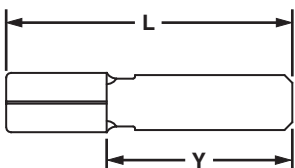

Part Number	Wire Range	Color Code	Max. Ins.	Figure Dimensions (In.)		Tab Size	Crimp Tool	Std. Pkg. Qty.**	Std. Ctn. Qty.
				L	Y				
D18-145M-C	22-18 AWG	—	—	.75	.42	.145 x .032	CT-100‡, CT-200‡, CT-600, CT-1570‡	100	500
D14-145M-C	16-14 AWG	—	—	.75	.42	.145 x .032		100	500

‡UL and CSA approved tooling/product combinations.

**To order in bulk, replace -C in the part number with -M for a bulk package of 1000.

System Overview

Terminals

Disconnects

Splices

Ferrules

Compression Connectors

Crimping Tools

Mechanical Connectors

Grounding Connectors

Support Products

Technical Info

Index

System Overview

Features and Benefits — PAN-TERM® Metric Disconnects

Terminals

Metric Nylon Fully Insulated Female and Male Tabs Type DMNF-FIB

Available in tab sizes to accommodate 2.8, 4.8 and 6.3mm tabs

Fully insulated design provides protection from electrical shorts

Expanded wire entry (on select sizes) accommodates large insulation or multiple wires

Maximum insulation temperature 125°C (257°F)

Insulation support restricts excessive wire movement to minimize stress on crimp joint

Funnel entry for faster wire insertion and lower installed cost

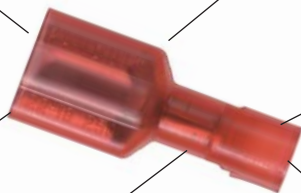

Splices

Ferrules

Compression Connectors

*Rated at 600V.

Crimping Tools

Vinyl Barrel Insulated Female Receptacles Type DMV

Available in tab sizes to accommodate 2.8, 4.8 and 6.3mm tabs

Maximum insulation temperature 105°C (221°F)



Insulation grip sleeve provides a superior insulation crimp for high vibration and high strain relief applications

Insulation support to protect electrical crimp

Mechanical Connectors

Grounding Connectors

Support Products

Technical Info

Index

*Rated at 600V.
**Flammability UL94V-0.

Nylon Barrel Insulated Female Receptacles and Male Tabs Type DMNF

Available in tab sizes to accommodate 2.8, 4.8 and 6.3mm tabs



Maximum insulation temperature 90°C (194°F)

Funnel entry for faster wire insertion and lower installed cost

*Rated at 600V.

Non-Insulated Female Receptacles and Male Tabs Type DM

Available in tab sizes to accommodate 2.8, 4.8 and 6.3mm tabs



Maximum recommended operating temperature 150°C (302°F)

Sleeved barrel assures crimp reliability

Part Number System for *PAN-TERM*® Metric Disconnects

DM	NF	1	—	285	FIB	—	C
Type: DM = <i>PAN-TERM</i> ® Disconnect Metric	Insulation: N = Nylon NF = Nylon Funnel V = Vinyl	Wire Range: 1 = .5–1.0mm ² 2 = 1.5–2.5mm ² 6 = 4.0–6.0mm ²	Size & Type: 285 = 2.8mm x .5mm 288 = 2.8mm x .8mm 488 = 4.8mm x .8mm 63 = 6.3mm x .8mm	Special Configuration: B = Butted Seam FI = Fully Insulated Female FIB = Fully Insulated Butted Seam Female FIM = Fully Insulated Male M = Male MB = Butted Seam Male	Package Size: X = 10 E = 20 Q = 25 L = 50 C = 100		

Female Metric Disconnects, Fully Insulated Nylon – Funnel Entry

Type DMNF-FIB

- Insulation support
- Internal wire stop

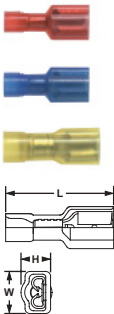

Part Number	Wire Range	Color Code	Max. Ins.	Figure Dimensions (mm)			Tab Size	Crimp Tool	Std. Pkg. Qty.	Std. Ctn. Qty.
				L	W	H				
DMNF1-285FIB-C	.5-1.0	Red	3.45	18.0	4.8	4.1	2.8 x .5	CT-1525	100	500
DMNF1-288FIB-C			3.45	18.0	4.8	4.1	2.8 x .8		100	500
DMNF1-488FIB-C			3.45	19.8	7.9	5.5	4.8 x .8		100	1000
DMNF1-63FIB-C	.5-1.5	Red	3.45	21.3	8.9	5.5	6.3 x .8		100	500
DMNF2-488FIB-C			4.06	19.8	7.9	5.5	4.8 x .8		100	1000
DMNF2-63FIB-C			4.06	21.3	8.9	5.5	6.3 x .8		100	500
DMNF6-63FI-L	2.5-6.0	Yellow	5.84	24.4	8.9	6.9	6.3 x .8	CT-1551	50	250

**Only DMNF1-488FIB and DMNF2-488FIB are available in bulk; to order, replace -C in the part number with -M for a bulk package of 1000.

Female Metric Disconnects, Nylon Barrel Insulated – Funnel Entry

Type DMNF

- Insulation grip sleeve

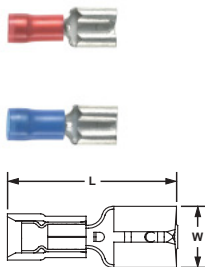

Part Number	Wire Range	Color Code	Max. Ins.	Figure Dimensions (mm)			Tab	Crimp Tool	Std. Pkg. Qty.	Std. Ctn. Qty.
				L	W	H				
DMNF1-285-C	.5-1.0	Red	2.54	17.8	3.8	2.0	2.8 x .5	CT-1551	100	500
DMNF1-288-C			2.54	17.8	3.8	2.0	2.8 x .8		100	500
DMNF1-488-C			3.30	19.6	5.8	2.5	4.8 x .8		100	500
DMNF1-63-C	.5-1.5	Red	3.30	20.7	7.4	3.05	6.3 x .8		100	500
DMNF2-488-C			4.06	19.6	5.8	2.5	4.8 x 0.8		100	500
DMNF2-63-C			4.06	21.8	7.4	3.05	6.3 x 0.8		100	500

Female Metric Disconnects, Vinyl Barrel Insulated – Funnel Entry

Type DMV

- Sleeved barrel

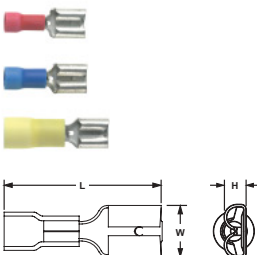

Part Number	Wire Range	Color Code	Max. Ins.	Figure Dimensions (mm)			Tab Size	Crimp Tool	Std. Pkg. Qty.	Std. Ctn. Qty.
				L	W	H				
DMV6-63-L	4.0-6.0	Yellow	6.22	25.7	7.6	3.3	6.3 x .8	CT-1551	50	250

System Overview

Female Metric Disconnects, Non-Insulated

Type DM

- Sleeved barrel

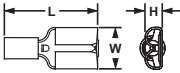

Part Number	Wire Range	Color Code	Max. Ins.	Figure Dimensions (mm)			Tab Size	Crimp Tool	Std. Pkg. Qty.	Std. Ctn. Qty.
				L	W	H				
DM1-488-C	.5-1.0	—	—	15.0	5.9	2.5	4.8 x .8	CT-1570	100	500
DM1-63-C	.5-1.5	—	—	19.2	6.3	.76	6.3 x .8		100	500
DM2-488-C	1.5-2.5	—	—	15.0	5.9	2.5	4.8 x .8		100	500
DM2-63-C	1.5-2.5	—	—	19.2	6.3	.76	6.3 x .8		100	500
DM6-63-L	2.5-6.0	—	—	19.3	7.4	.76	6.3 x .8		50	250

Terminals

Disconnects

Male Metric Disconnects, Fully Insulated Nylon – Funnel Entry

Type DMNF-FIM

- Insulation support



Part Number	Wire Range	Color Code	Max. Ins.	Figure Dimensions (mm)			Tab Size	Crimp Tool	Std. Pkg. Qty.	Std. Ctn. Qty.
				L	W	H				
DMNF1-63FIM-C	.5-1.0	Red	3.45	22.7	10.29	7.3	6.3 x .8	CT-1525	100	500
DMNF2-63FIM-C	1.5-2.5	Blue	4.06	22.9	10.41	7.05	6.3 x .8		100	500

Splices

Ferrules

Male Metric Disconnects, Nylon Barrel Insulated – Funnel Entry

Type DMNF-M

- Insulation grip sleeve



Part Number	Wire Range	Color Code	Max. Ins.	Figure Dimensions (mm)	Tab Size	Crimp Tool	Std. Pkg. Qty.	Std. Ctn. Qty.
				L				
DMNF1-63M-C	.5-1.5	Red	3.94	22.7	6.3 x .8	CT-1551	100	500
DMNF2-63M-C	1.5-2.5	Blue	4.32	23.6	6.3 x .8		100	500
DMNF6-63M-L	2.5-6.0	Yellow	5.84	23.6	6.3 x .8		50	250

Compression Connectors

Crimping Tools

Mechanical Connectors

Male Metric Disconnects, Non-Insulated

Type DM-M



Part Number	Wire Range	Color Code	Max. Ins.	Figure Dimensions (mm)	Tab Size	Crimp Tool	Std. Pkg. Qty.	Std. Ctn. Qty.
				L				
DM1-63M-C	.5-1.5	—	—	19.2	6.3 x .8	CT-1570	100	500
DM2-63M-C	1.5-2.5	—	—	19.2	6.3 x .8		100	500
DM6-63M-L	2.5-6.0	—	—	18.2	6.3 x .8		50	250

Grounding Connectors

Support Products

Piggyback Metric Disconnects, Vinyl Barrel Insulated

Type DMV-P

- Insulation grip sleeve
- Female and male tabs combined in one disconnect
- Allows additional circuits to be added to existing equipment or ability to add future circuits — no costly rework or product changes needed

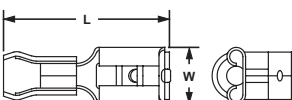
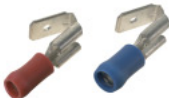

Part Number	Wire Range	Color Code	Max. Ins.	Figure Dimensions (mm)		Tab Size	Crimp Tool	Std. Pkg. Qty.	Std. Ctn. Qty.
				L	W				
DMV1-63P-C	.5-1.5	Red	3.68	22.4	7.4	6.3 x .8	CT-1551	100	500
DMV2-63P-C	1.5-2.5	Blue	4.06	22.4	7.4	6.3 x .8		100	500

Technical Info

Index

PAN-TERM® SPLICES

PANDUIT® PAN-TERM® Splices are designed and manufactured for fast assembly, and long reliable performance. As the demand for splices increases, it becomes essential to provide a complete system for termination products. We provide an extensive line of tooling designed specifically to provide optimum performance when used as a system for terminating.



- Suitable for in-line, parallel and group splicing of wires
- Nylon and vinyl insulated as well as non-insulated
- Available in sizes from #26 AWG – #10 AWG
- Internal wire stops on butt splices prevent over insertion of wires
- Applicable sizes are UL Listed and CSA Certified, as noted
- Wide assortment of manual, controlled cycle, battery operated hydraulic and pneumatic crimping tools for reliable connections at the lowest installed cost

PANDUIT® continually provides new designs to meet the application challenges encountered by our customers. PANDUIT® offers a wide assortment of PAN-TERM® termination products to meet customer needs at the lowest installed cost.

System Overview

Terminals

Disconnects

Splices

Ferrules

Compression Connectors

Crimping Tools

Mechanical Connectors

Grounding Connectors

Support Products

Technical Info

Index

System Overview

Features and Benefits — PAN-TERM® Splices and Wire Joints

Terminals

Non-Insulated Wire Joints Type J

Only one crimp needed to complete splice

Maximum recommended operating temperature 150°C (302°F)



Internally beveled barrel for quick easy wire insertion



*UL and CSA rated up to 600V.

Non-Insulated Parallel Splices Type PS

Seamless tubular barrel provides consistent high performance quality crimps

Maximum recommended operating temperature 150°C (302°F)



Only one crimp needed to complete splice



*UL and CSA rated up to 300V.

Splices

Ferrules

Compression Connectors

Crimping Tools

Nylon Wire Joints Type JN

Fully insulated housing protects crimp joint

Maximum insulation temperature 105°C (221°F)



Only one crimp needed to complete splice

Deep skirt to accommodate multiple variations of wire combinations



*UL and CSA rated up to 600V
** Metric versions available

Nylon Parallel Splices Type PSN

Maximum insulation temperature 105°C (221°F)



Only one crimp needed to complete splice

Mechanical Connectors

Grounding Connectors

Support Products

Technical Info

Index

Features and Benefits — PAN-TERM® Splices

Nylon Butt Splices Type BSN

Internal wire stops assure proper insertion length



Maximum insulation temperature 105°C (221°F)

Brazed seam assures crimp reliability



*UL and CSA rated up to 600V.

Vinyl Butt Splices Type BSV

Internal wire stops assure proper insertion length



Maximum insulation temperature 105°C (221°F)

Expanded wire entry accommodates larger insulation

Brazed seam assures crimp reliability



*UL and CSA rated up to 600V.
**Flammability – UL94V-0.
*** Metric versions available.

Non-Insulated Butt Splices Type BS

Internal wire stops assure proper insertion length

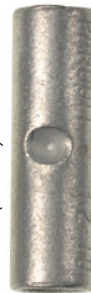

Brazed seam assures crimp reliability

Maximum recommended operating temperature 150°C (302°F)

Internally beveled barrel for quick easy wire insertion



*UL and CSA rated up to 600V.
**Metric versions available.

System Overview

Terminals

Disconnects

Splices

Ferrules

Compression Connectors

Crimping Tools

Mechanical Connectors

Grounding Connectors

Support Products

Technical Info

Index

System Overview

Selection Guide — PAN-TERM® Splices and Wire Joints

Terminals

Disconnects

Splices

Ferrules



Splices & Wire Joints

Nylon	Butt Splice	Brazed Seam	BSN	Pg. D5
	Parallel Splice	Seamless Barrel	PSN	Pg. D6
	Wire Joint	Multiple Wire Connector	JN	Pg. D6
Vinyl	Butt Splice	Expanded Insulation	BSV	Pg. D5
Heat Shrink	Butt Splice	Heat Shrink Insulation	BSH	Pg. D7
Non-Insulated	Butt Splice	Brazed Seam	BS	Pg. D5
	Parallel Splice	Seamless Barrel	PS	Pg. D6
	Wire Joint		J	Pg. D7

Compression Connectors

Part Number System for PAN-TERM® Splices

BS	V	14	X	—	M
Type	Insulation	Wire Range	Special Configuration		Std. Pkg. Size
BS = Butt Splice PS = Parallel Splice	N = Nylon V = Vinyl	22 = #26-22 18 = #22-18 14 = #16-14 13 = #14-12 10 = #12-10	X = Expanded Insulation		X = 10 Q = 25 L = 50 C = 100 T = 200 D = 500 M = 1000

Grounding Connectors

Part Number System for PAN-TERM® Wire Joints

JN	418-212	—	C
Type	Wire Range		Std. Pkg. Size
J = Non-Insulated JN = Nylon-Insulated	J Types 214-312 = 2 #14-3 #12 318-412 = 3 #14-4 #12 216-410 = 2 #16-4 #10 Wire Range JN Types 224-318 = 2 #24-3 #18 218-216 = 2 #18-2 #16 418-212 = 4 #18-2 #12 314-412 = 3 #14-4 #12		X = 10 Q = 25 L = 50 C = 100 T = 200 D = 500 M = 1000

Technical Info

Index



Butt Splice, Nylon Insulated

Type BSN

- Brazed seam
- Internal wire stops assure proper insertion length

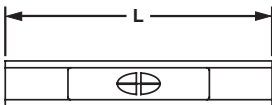

Part Number	Wire Range	Color Code	Max. Ins.	Figure Dim. (In.)	Crimp Tool	Std. Pkg. Qty.**	Std. Ctn. Qty.
				L			
BSN22-C*	26-22 AWG	Yellow	.080	.79	CT-100, CT-1525	100	1000
BSN18-C	22-18 AWG	Red	.115	1.15	CT-100, CT-600, CT-1550, CT-1551	100	1000
BSN14-C	16-14 AWG	Blue	.148	1.15	CT-100, CT-600, CT-1550, CT-1551	100	1000
BSN10-L	12-10 AWG	Yellow	.210	1.21	CT-100, CT-600, CT-1550, CT-1551	50	500

*Part number BSN22-C, is not UL Listed.

**To order in bulk, replace -C in the part number with -M for a bulk package of 1000 and replace -L with -D for a bulk package of 500.



Butt Splice, Vinyl Insulated

Type BSV

- Expanded insulation
- Insulation support
- Internal wire stops assure proper insertion length

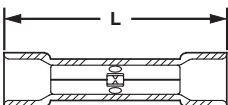

Part Number	Wire Range	Color Code	Max. Ins.	Figure Dim. (In.)	Crimp Tool	Std. Pkg. Qty.**	Std. Ctn. Qty.
				L			
BSV18X-C	22-18 AWG	Red	.183	1.03	CT-100, CT-600, CT-1550, CT-1551	100	1000
BSV14X-C	16-14 AWG	Blue	.211	1.04		100	1000
BSV10X-L	12-10 AWG	Yellow	.260	1.17		50	500

**To order in bulk, replace -C in the part number with -M for a bulk package of 1000 and replace -L with -D for a bulk package of 500.



Butt Splice, Non-Insulated

Type BS

- Brazed seam
- Internal wire stops assure proper insertion length

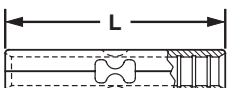

Part Number	Wire Range	Color Code	Max. Ins.	Figure Dim. (In.)	Crimp Tool	Std. Pkg. Qty.**	Std. Ctn. Qty.
				L			
BS22-C*	26-22 AWG	—	—	.47	CT-100	100	1000
BS18-C	22-18 AWG	—	—	.62	CT-100, CT-200, CT-600, CT-1570	100	1000
BS14-C	16-14 AWG	—	—	.62	CT-100, CT-200, CT-600, CT-1570	100	1000
BS10-L	12-10 AWG	—	—	.72	CT-100, CT-200, CT-600, CT-1570	50	500

*Part number BS22-C, is not UL Listed.

**To order in bulk, replace -C in the part number with -M for a bulk package of 1000 and replace -L with -D for a bulk package of 500.

System Overview

Terminals

Disconnects

Splices

Ferrules

Compression Connectors

Crimping Tools

Mechanical Connectors

Grounding Connectors

Support Products

Technical Info

Index

System Overview

Parallel Splice, Nylon Insulated Type PSN

- Only one crimp needed to complete splice

Terminals



Disconnects

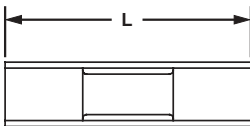

Part Number	Wire Range	Color Code	Max. Ins.	Figure Dim. (In.)	Wire Strip Length (In.)	Crimp Tool	Std. Pkg. Qty.**	Std. Ctn. Qty.
				L				
PSN18-C	22-18 AWG	Red	.129	.75	5/16	CT-100, CT-1525	100	500
PSN16-C	20-16 AWG	Blue	.150	.75	5/16		100	500
PSN12-L	14-12 AWG	Yellow	.204	.83	7/16		50	500

**To order in bulk, replace -C in the part number with -M for a bulk package of 1000 and replace -L with -D for a bulk package of 500.

Splices



Parallel Splice, Non-Insulated Type PS

Type PS

- Only one crimp needed to complete splice

Ferrules



Compression Connectors



Crimping Tools

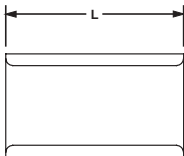

Part Number	Wire Range	Color Code	Max. Ins.	Figure Dim. (In.)	Wire Strip Length (In.)	Crimp Tool	Std. Pkg. Qty.**	Std. Ctn. Qty.
				L				
PS18-C	22-18 AWG	—	—	.29	5/16	CT-100, CT-200	100	500
PS16-C	20-16 AWG	—	—	.29	5/16		100	500
PS12-L	14-12 AWG	—	—	.38	7/16		50	500

**To order in bulk, replace -C in the part number with -M for a bulk package of 1000 and replace -L with -D for a bulk package of 500.

Mechanical Connectors



Wire Joint, Nylon Insulated Type JN

Type JN

- Wire joints are used to crimp groups of wires
- Fully pre-insulated to prevent shorting and shocks

Grounding Connectors



Technical Info

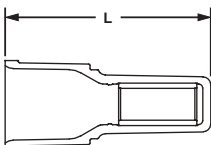

Part Number	Wire Range	Color Code	CMA Range		Figure Dim. (In.)	Wire Strip Length	Crimp Tool	Std. Pkg. Qty.**	Std. Ctn. Qty.
			Min.	Max.	L				
JN224-318-C	2 #24 – 2 #16	Red	808	5160	.78	7/16	CT-1550‡, CT-1551‡	100	1000
JN218-216-C	2 #22 – 2 #16	Clear	1284	5160	.78	7/16	CT-1550‡, CT-1551‡	100	1000
JN418-212-C	4 #18 – 2 #12	Clear	6480	14750	.93	1/2	CT-100‡, CT-1550‡, CT-1551‡	100	1000
JN314-412-C*	3 #14 – 4 #12	Clear	10320	26120	.97	5/8	CT-100‡, CT-160‡, CT-260‡	100	1000

*Part number JN314-412, is not UL Listed.

**To order in bulk, replace -C in the part number with -M for a bulk package of 1000.

‡UL and CSA approved tooling/product combinations.

Index



Wire Joint, Non-Insulated

Type J

- Non-insulated

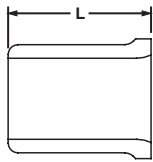

Part Number	Wire Range	Color Code	CMA Range		Figure Dim.	Wire Strip Length	Crimp Tool	Std. Pkg. Qty.**	Std. Ctn. Qty.
			Min.	Max.	(In.) L				
J214-312-T	2 #14 - 3 #12	—	5760	19590	.37	1/2	CT-100‡, CT-200‡	200	2000
J318-412-T	3 #18 - 4 #12	—	4860	27330	.37	1/2	CT-100‡, CT-200‡	200	2000
J216-410-L*	2 #16 - 4 #10	—	5160	41600	.62	3/4	CT-100‡, CT-200‡	50	500

▲*Part number J216-410, is not UL Listed or CSA Certified.

**To order in bulk, replace -T in the part number with -2M for a bulk package of 2000 and replace -L with -D for a bulk package of 500.

‡UL and CSA approved tooling/product combinations.

Heat Shrink, Butt Splices

Type BSH

- Form a protective barrier that provides environmentally sealed terminations
- Provide excellent strain relief for improved crimp integrity
- After crimping, heat shrink insulation is activated with a standard heat gun or an open flame
- Adhesive lined heat shrink

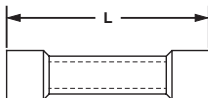

Part Number	Wire Range	Color Code	Max. Ins.	Figure Dim.	Wire Strip Length	Crimp Tool	Std. Pkg. Qty.	Std. Ctn. Qty.
				(In.) L				
BSH18-Q	22-18 AWG	Red	.170	1.45	5/16	CT-310	25	125
BSH14-Q*	16-14 AWG	Blue	.190	1.45	5/16	CT-310	25	125
BSH10-E	12-10 AWG	Yellow	.240	1.64	5/16	CT-310	20	100

*Available in bulk, to order, replace -Q in the part number with -D for a bulk package of 500.

Metric Butt Splice, Vinyl Insulated

Type BSMV

- Expanded insulation
- Insulation support
- Internal wire stops
- Butted seam

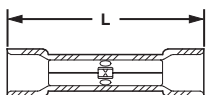

Part Number	Wire Range	Color Code	Max. Ins.	Figure Dim.	Crimp Tool	Std. Pkg. Qty.	Std. Ctn. Qty.
				(In.) L			
BSMV1BX-C**	.5 – 1.0	Red	4.3	26.6	CT-1551	100	500
BSMV2BX-C**	1.5 – 2.5	Blue	5.1	26.6	CT-1551	100	500
BSMV6X-L*	4.0 – 6.0	Yellow	6.4	30.0	CT-1551	50	250

*Brazeed seam.

**Available in bulk, to order, replace -C in the part number with -M for a bulk package of 1000.

System Overview

Terminals

Disconnects

Splices

Ferrules

Compression Connectors

Crimping Tools

Mechanical Connectors

Grounding Connectors

Support Products

Technical Info

Index

System Overview

Metric Butt Splice, Non-Insulated Type BSM

Terminals

- Brazed seam
- Internal wire stops



Disconnects



Splices

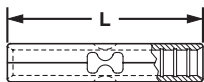

Part Number	Wire Range	Color Code	Max. Ins.	Figure Dim. (mm)	Crimp Tool	Std. Pkg. Qty.	Std. Ctn. Qty.
				L			
BSM1-C	.5 – 1.0	—	—	15.7	CT-1570	100	500
BSM2-C	1.5 – 2.5	—	—	15.7		100	500
BSM6-L	2.5 – 6.0	—	—	1.60		50	250

Ferrules

Metric Wire Joints, Nylon Insulated Type JMN

Compression Connectors



Crimping Tools



Mechanical Connectors

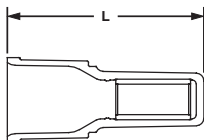

Part Number	Wire Range	Color Code	CMA Range Min.	CMA Range Max.	Figure Dim. (mm)	Crimp Tool	Std. Pkg. Qty.	Std. Ctn. Qty.
					L			
JMN2-C	.5 - 2.5	Clear	1284	5160	19.9	CT-1551	100	500
JMN6-C	.75 - 6.0	Clear	6480	14750	23.9	CT-1551	100	500

Grounding Connectors

Support Products

Technical Info

Index

PAN-TERM® FERRULES

PANDUIT® PAN-TERM® Ferrule end sleeves terminate stranded wire into terminal blocks with superior termination performance. A wide assortment of ferrule styles and tool designs provide a proven way to make reliable connections, especially for limited space applications. Insulation flare allows for ease of wire insertion and eliminates loose strands of wire. Encapsulated crimp contains loose wires to eliminate stray wire breakage.



- Insulated single wire range of #26 – #1 AWG, sizes meets French and DIN color code standards
- Insulated twin wire end sleeve range of #22 – #10 AWG, sizes meets DIN color code standard
- Non-insulated wire range of #24 – #1 AWG
- Ideal for control panel and terminal block applications
- Wide assortment of manual, controlled cycle, battery operated hydraulic and pneumatic crimping tools for reliable connections at the lowest installed cost

PANDUIT® continually provides new designs to meet the application challenges encountered by our customers. PANDUIT® offers a wide assortment of PAN-TERM® termination products to meet customer needs at the lowest installed cost.

System Overview

Terminals

Disconnects

Splices

Ferrules

Compression Connectors

Crimping Tools

Mechanical Connectors

Grounding Connectors

Support Products

Technical Info

Index

System Overview

Features and Benefits — *PAN-TERM*® Ferrules

Terminals

PANDUIT® Ferrules are available for wiring applications from #26 AWG to #1 AWG. Offerings include insulated and non-insulated ferrules, in single-wire or double-wire configurations. Insulated ferrules are color coded to DIN or French standards.

Disconnects

Insulated Ferrules — Single Wire Type FSF and FSD

Seamless tubular barrel provides consistent quality crimps



Maximum insulation temperature 89°C (192°F)

Color coded polypropelene identifies wire range. (German and French codes available)

Splices

Insulated Ferrules — Twin Wire Type FTD

Oversized seamless tubular barrel provides consistent, high performance quality crimps for two wire applications



Maximum insulation temperature 89°C (192°F)

Color coded polypropelene identifies wire range. (German and French codes available)

Ferrules

Non-Insulated Ferrules

Type F

Seamless tubular barrel provides consistent quality crimps



Maximum operating temperature 89°C (192°F)

Internally beveled barrel for quick easy wire insertion

Compression Connectors

Crimping Tools

Mechanical Connectors

Part Number System for *PAN-TERM*® Ferrules



F = Ferrule

S = Single

D = DIN

F = French

T = Twin

Blank = Non-Insulated

Support Products

Technical Info

Index

Selection Guide — PAN-TERM® Ferrules

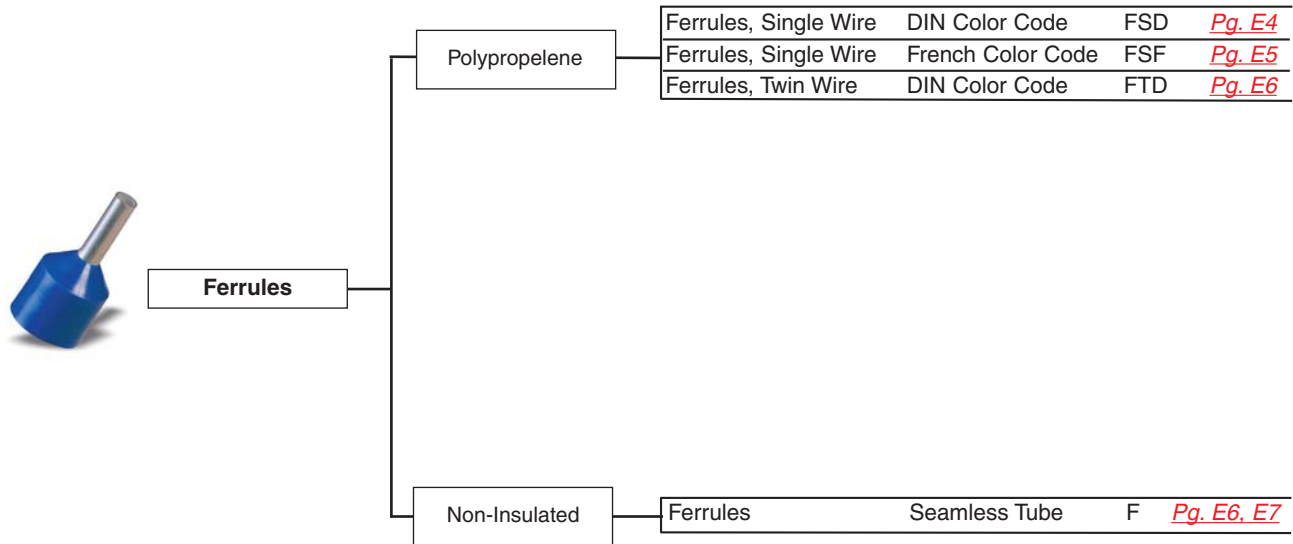

System Overview

Terminals

Disconnects

Splices

Ferrules

Compression Connectors

Crimping Tools

Mechanical Connectors

Grounding Connectors

Support Products

Technical Info

Index

System Overview

Insulated Ferrules – Single Wire DIN End Sleeve Type FSD

Terminals

- Ease of wire insertion eliminates loose strands of wire
- Wire strands will not fray or spread
- No unwanted contacts when installing or removing the wire
- Maximizes a reliable electrical connection
- Encapsulated crimp eliminates stray wire breakage
- Great for limited space applications

Disconnects

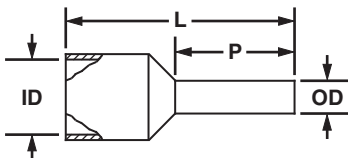

Splices

DIN	Wire Size		DIN	Dimensions								Wire Strip Length		Crimp Tool	Std. Pkg. Qty.	
	Part Number	AWG		mm ²	Color Code	L		P		ID		OD				
					In.	mm	In.	mm	In.	mm	In.	mm	In.	mm		
					.41	10.5	.24	6.0	.08	2.0	.05	1.3	3/8	9.5	CT-1002	500
					.49	12.5	.31	8.0	.08	2.0	.05	1.3	15/32	11.9		500
					.41	10.5	.24	6.0	.08	2.0	.05	1.3	3/8	9.5		500
					.49	12.5	.31	8.0	.08	2.0	.05	1.3	15/32	11.9		500
					.41	10.5	.24	6.0	.08	2.0	.05	1.3	3/8	9.5		500
					.49	12.5	.31	8.0	.08	2.0	.05	1.3	15/32	11.9		500
					.45	11.5	.24	6.0	.10	2.5	.06	1.4	3/8	9.5	500	
					.53	13.5	.31	8.0	.10	2.5	.06	1.4	15/32	11.9	500	
					.61	15.5	.24	10.0	.10	2.5	.06	1.4	17/32	13.5	500	
					.47	12.0	.24	6.0	.11	2.8	.06	1.6	3/8	9.5	500	
					.55	14.0	.31	8.0	.11	2.8	.06	1.6	15/32	11.9	500	
					.63	16.0	.39	10.0	.11	2.8	.06	1.6	17/32	13.5	500	
					.71	18.0	.47	12.0	.11	2.8	.06	1.6	5/8	15.9	500	
					.49	12.5	.24	6.0	.12	3.0	.07	1.8	3/8	9.5	500	
					.57	14.5	.31	8.0	.12	3.0	.07	1.8	15/32	11.9	500	
					.65	16.5	.39	10.0	.12	3.0	.07	1.8	17/32	13.5	500	
					.73	18.5	.47	12.0	.12	3.0	.07	1.8	5/8	15.9	500	
					.49	12.5	.24	6.0	.13	3.4	.08	2.1	3/8	9.5	500	
					.57	14.5	.31	8.0	.13	3.4	.08	2.1	15/32	11.9	500	
					.65	16.5	.39	10.0	.13	3.4	.08	2.1	17/32	13.5	500	
					.73	18.5	.47	12.0	.13	3.4	.08	2.1	5/8	15.9	500	
					.96	24.5	.71	18.0	.13	3.4	.08	2.1	7/8	22.2	500	
					.57	14.5	.31	8.0	.14	3.6	.09	2.4	15/32	11.9	500	
					.59	15.0	.31	8.0	.17	4.2	.10	2.6	15/32	11.9	500	
					.75	19.0	.47	12.0	.17	4.2	.10	2.6	5/8	15.9	500	
					.98	25.0	.71	18.0	.17	4.2	.10	2.6	7/8	22.2	500	
					.69	17.5	.39	10.0	.19	4.8	.13	3.3	17/32	13.5	500	
					.79	20.0	.47	12.0	.19	4.8	.13	3.3	5/8	15.9	100	
					1.02	26.0	.71	18.0	.19	4.8	.13	3.3	7/8	22.2	100	
					.79	20.0	.47	12.0	.24	6.2	.16	4.0	5/8	15.9	100	
					1.02	26.0	.71	18.0	.24	6.2	.16	4.0	7/8	22.2	100	
					.83	21.0	.47	12.0	.30	7.5	.20	5.0	5/8	15.9	100	
					1.06	27.0	.71	18.0	.30	7.5	.20	5.0	7/8	22.2	100	
					.91	23.0	.47	12.0	.35	8.8	.25	6.4	5/8	15.9	100	
					1.14	29.0	.71	18.0	.35	8.8	.25	6.4	7/8	22.2	100	
					1.14	29.0	.63	16.0	.43	11.0	.31	7.9	3/4	19.1	50	
					1.22	31.0	.71	18.0	.43	11.0	.31	7.9	7/8	22.2	50	
					1.38	35.0	.87	22.0	.43	11.0	.31	7.9	1	25.4	50	
					1.18	30.0	.63	16.0	.49	12.5	.35	8.9	3/4	19.1	50	
					1.26	32.0	.71	18.0	.49	12.5	.35	8.9	7/8	22.2	50	
					1.54	39.0	.98	25.0	.49	12.5	.35	8.9	1 1/8	28.6	50	
					1.42	36.0	.79	20.0	.59	15.0	.44	11.1	15/16	23.8	50	
					1.61	41.0	.98	25.0	.59	15.0	.44	11.1	1 1/8	28.6	25	

Insulated Ferrules – Single Wire French End Sleeve Type FSF

- Ease of wire insertion eliminates loose strands of wire
- Wire strands will not fray or spread
- No unwanted contacts when installing or removing the wire
- Maximizes a reliable electrical connection
- Encapsulated crimp eliminates stray wire breakage
- Great for limited space applications

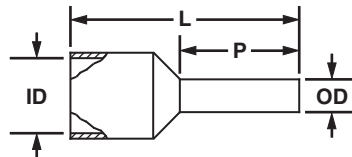
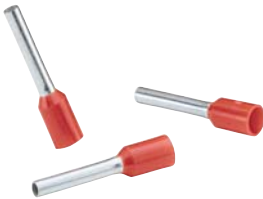

French Part Number	Wire Size		French Color Code	Dimensions								Wire Strip Length		Crimp Tool	Std. Pkg. Qty.
	AWG	mm ²		L		P		ID		OD		In.	mm		
			In.	mm	In.	mm	In.	mm	In.	mm	In.	mm			
FSF72-6-D	26 AWG	.14	Brown	.41	10.5	.24	6.0	.08	2.0	.05	1.3	3/8	9.5	CT-1002	500
FSF72-8-D				.49	12.5	.31	8.0	.08	2.0	.05	1.3	15/32	11.9		500
FSF73-6-D	24 AWG	.25	Violet	.41	10.5	.24	6.0	.08	2.0	.05	1.3	3/8	9.5	CT-1002	500
FSF73-8-D				.49	12.5	.31	8.0	.08	2.0	.05	1.3	15/32	11.9		500
FSF74-6-D	22 AWG	.34	Pink	.41	10.5	.24	6.0	.08	2.0	.05	1.3	3/8	9.5	CT-1002	500
FSF74-8-D				.49	12.5	.31	8.0	.08	2.0	.05	1.3	15/32	11.9		500
FSF75-6-D	20 AWG	.50	White	.45	11.5	.24	6.0	.10	2.5	.06	1.4	3/8	9.5	CT-1002, CT-1003	500
FSF75-8-D				.53	13.5	.31	8.0	.10	2.5	.06	1.4	15/32	11.9		500
FSF75-10-D				.61	15.5	.39	10.0	.10	2.5	.06	1.4	17/32	13.5		500
FSF76-6-D	18 AWG	.75	Blue	.47	12.0	.24	6.0	.11	2.8	.06	1.6	3/8	9.5	CT-1002, CT-1003	500
FSF76-8-D				.55	14.0	.31	8.0	.11	2.8	.06	1.6	15/32	11.9		500
FSF76-10-D				.63	16.0	.39	10.0	.11	2.8	.06	1.6	17/32	13.5		500
FSF76-12-D	16 AWG	1.00	Red	.71	18.0	.47	12.0	.11	2.8	.06	1.6	5/8	15.9	CT-1002, CT-1003	500
FSF77-6-D				.49	12.5	.24	6.0	.12	3.0	.07	1.8	3/8	9.5		500
FSF77-8-D				.57	14.5	.31	8.0	.12	3.0	.07	1.8	15/32	11.9		500
FSF77-10-D	14 AWG	1.50	Black	.65	16.5	.39	10.0	.12	3.0	.07	1.8	17/32	13.5	CT-1002, CT-1003	500
FSF77-12-D				.73	18.5	.47	12.0	.12	3.0	.07	1.8	5/8	15.9		500
FSF78-6-D				.49	12.5	.24	6.0	.13	3.4	.08	2.1	3/8	9.5		500
FSF78-8-D	12 AWG	2.08	Yellow	.57	14.5	.31	8.0	.13	3.4	.08	2.1	15/32	11.9	CT-1002, CT-1003	500
FSF78-10-D				.65	16.5	.39	10.0	.13	3.4	.08	2.1	17/32	13.5		500
FSF78-12-D				.73	18.5	.47	12.0	.13	3.4	.08	2.1	5/8	15.9		500
FSF78-18-D	10 AWG	2.50	Gray	.96	24.5	.71	18.0	.13	3.4	.08	2.1	7/8	22.2	CT-1002, CT-1003	500
FSF79-8-D				.57	14.5	.31	8.0	.14	3.6	.09	2.4	15/32	11.9		500
FSF80-8-D				.59	15.0	.31	8.0	.17	4.2	.10	2.6	15/32	11.9		500
FSF80-12-D	8 AWG	4.00	Orange	.75	19.0	.47	12.0	.17	4.2	.10	2.6	5/8	15.9	CT-1003, CT-1004	500
FSF80-18-D				.98	25.0	.71	18.0	.17	4.2	.10	2.6	7/8	22.2		500
FSF81-10-D				.69	17.5	.39	10.0	.19	4.8	.13	3.3	17/32	13.5		500
FSF81-12-C	6 AWG	6.00	Green	.79	20.0	.47	12.0	.19	4.8	.13	3.3	5/8	15.9	CT-1004	100
FSF81-18-C				1.02	26.0	.71	18.0	.19	4.8	.13	3.3	7/8	22.2		100
FSF82-12-C				.79	20.0	.47	12.0	.24	6.2	.16	4.0	5/8	15.9		100
FSF82-18-C	4 AWG	10.0	Brown	1.02	26.0	.71	18.0	.24	6.2	.16	4.0	7/8	22.2	CT-1005	100
FSF83-12-C				.83	21.0	.47	12.0	.30	7.5	.20	5.0	5/8	15.9		100
FSF83-18-C				1.06	27.0	.71	18.0	.30	7.5	.20	5.0	7/8	22.2		100
FSF84-12-C	2 AWG	16.0	White	.91	23.0	.47	12.0	.35	8.8	.25	6.4	5/8	15.9	CT-1006	100
FSF84-18-C				1.14	29.0	.71	18.0	.35	8.8	.25	6.4	7/8	22.2		100
FSF85-16-L	1 AWG	25.0	Black	1.14	29.0	.63	16.0	.43	11.0	.31	7.9	3/4	19.1	CT-1005	50
FSF85-18-L				1.22	31.0	.71	18.0	.43	11.0	.31	7.9	7/8	22.2		50
FSF85-22-L				1.38	35.0	.87	22.0	.43	11.0	.31	7.9	1	25.4		50
FSF86-16-L	1 AWG	35.0	Red	1.18	30.0	.63	16.0	.49	12.5	.35	8.9	3/4	19.1	CT-1006	50
FSF86-18-L				1.26	32.0	.71	18.0	.49	12.5	.35	8.9	7/8	22.2		50
FSF86-25-L				1.54	39.0	.98	25.0	.49	12.5	.35	8.9	1 1/8	28.6		50
FSF87-20-L	1 AWG	50.0	Blue	1.42	36.0	.79	20.0	.59	15.0	.44	11.1	15/16	23.8	CT-1006	50
FSF87-25-Q				1.61	41.0	.98	25.0	.59	15.0	.44	11.1	1 1/8	28.6		25

System Overview

Insulated Ferrules – Twin Wire DIN End Sleeve Type FTD

Terminals

- Ease of wire insertion eliminates loose strands of wire
- Wire strands will not fray or spread
- No unwanted contacts when installing or removing the wire
- Maximizes a reliable electrical connection
- Encapsulated crimp eliminates stray wire breakage
- Great for limited space applications

Disconnects

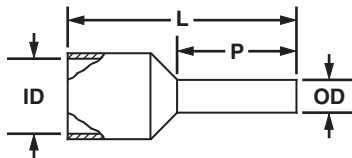
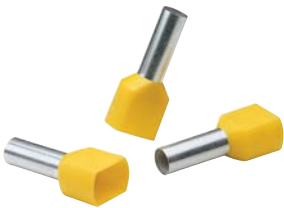

Splices

DIN	Wire Size		DIN	Dimensions								Wire Strip Length		Crimp Tool	Std. Pkg. Qty.	
	Part Number	AWG		mm ²	Color Code	L		P		ID		OD				
					In.	mm	In.	mm	In.	mm	In.	mm	In.	mm		
FTD75-8-D	22 AWG	.50	White		.59	15.0	.31	8.0	.06	1.5	.07	1.8	7/16	11.2	CT-1002, CT-1003	500
FTD76-8-D	20 AWG	.75	Gray		.59	15.0	.31	8.0	.07	1.8	.08	2.1	7/16	11.2		500
FTD76-10-D					.67	17.0	.39	10.0	.07	1.8	.08	2.1	9/16	14.0		500
FTD77-8-D	18 AWG	1.00	Red		.59	15.0	.31	8.0	.08	2.1	.09	2.4	7/16	11.2		500
FTD77-10-D					.67	17.0	.39	10.0	.08	2.1	.09	2.4	9/16	14.0		500
FTD78-8-D	16 AWG	1.50	Black		.63	16.0	.31	8.0	.09	2.3	.10	2.6	7/16	11.2		500
FTD78-12-D					.79	20.0	.47	12.0	.09	2.3	.10	2.6	21/32	16.8		500
FTD80-10-TL	14 AWG	2.50	Blue		.73	18.5	.39	10.0	.11	2.9	.13	3.3	9/16	14.0		250
FTD80-13-TL	14 AWG	2.50			.85	21.5	.51	13.0	.11	2.9	.13	3.3	23/32	16.2		250
FTD81-12-C	12 AWG	4.00	Gray		.91	23.0	.47	12.0	.15	3.8	.17	4.2	21/32	16.8		100
FTD82-14-C	10 AWG	6.00	Yellow		.98	25.0	.55	14.0	.18	4.6	.20	5.0	25/32	19.6	CT-1003, CT-1004	100

Ferrules

Compression Connectors

Crimping Tools

Ferrules, Non-Insulated Type F

- Ease of wire insertion eliminates loose strands of wire
- Wire strands will not fray or spread
- No unwanted contacts when installing or removing the wire
- Maximizes a reliable electrical connection
- Encapsulated crimp eliminates stray wire breakage
- Great for limited space applications

Mechanical Connectors

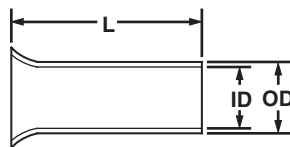

Grounding Connectors

Part Number	Wire Size		Dimensions								Wire Strip Length		Crimp Tool	Std. Pkg. Qty.
	AWG	mm ²	L		ID		OD		In.	mm				
			In.	mm	In.	mm	In.	mm	In.	mm				
F73-5-M	24 AWG	.25	.20	5.00	.03	.80	.04	1.1	7/32	5.00	CT-1002, CT-1003	1000		
F73-7-M				.28	7.00	.03	.80	.04	1.1	9/32		7.0	1000	
F74-5-M		.34	.20	5.00	.04	.90	.05	1.2	7/32	5.0		1000		
F74-7-M				.28	7.00	.04	.90	.05	1.2	9/32		7.0	1000	
F75-6-M	22 AWG	.50	.24	6.00	.04	1.0	.05	1.3	1/4	6.0		1000		
F75-8-M				.31	8.00	.04	1.0	.05	1.3	5/16		8.0	1000	
F75-10-M			.39	10.0	.04	1.0	.05	1.3	13/32	10.0		1000		
F76-6-M		20 AWG	.75	.24	6.00	.05	1.2	.06	1.5	1/4		6.0	1000	
F76-8-M				.31	8.00	.05	1.2	.06	1.5	5/16		8.0	1000	
F76-10-M			.39	10.0	.05	1.2	.06	1.5	13/32	10.0		1000		
F76-12-M			.47	12.0	.05	1.2	.06	1.5	15/32	12.0	1000			
F77-6-M	18 AWG	1.00	.24	6.00	.06	1.4	.07	1.7	1/4	6.0	1000			
F77-7-M				.28	7.00	.06	1.4	.07	1.7	9/32	7.0	1000		
F77-8-M				.31	8.00	.06	1.4	.07	1.7	5/16	8.0	1000		
F77-10-M				.39	10.0	.06	1.4	.07	1.7	13/32	10.0	1000		
F77-12-M				.47	12.0	.06	1.4	.07	1.7	15/32	12.0	1000		

Index

Chart continues on page E7

Ferrules, Non-Insulated (continued) Type F

Part Number	Wire Size		Dimensions						Wire Strip Length		Crimp Tool	Std. Pkg. Qty.		
	AWG	mm ²	L		ID		OD		In.	mm				
			In.	mm	In.	mm	In.	mm						
F78-7-M	16 AWG	1.50	.28	7.00	.07	1.7	.08	2.0	9/32	7.0	CT-1002, CT-1003	1000		
F78-8-M			.31	8.00	.07	1.7	.08	2.0	5/16	8.0		1000		
F78-10-M			.39	10.0	.07	1.7	.08	2.0	13/32	10.0		1000		
F78-12-M			.47	12.0	.07	1.7	.08	2.0	15/32	12.0		1000		
F78-15-M			.59	15.0	.07	1.7	.08	2.0	19/32	15.0		1000		
F78-18-M		1.00	.71	18.0	.07	1.7	.08	2.0	23/32	18.0		1000		
F78-20-M			.79	20.0	.07	1.7	.08	2.0	25/32	20.0		1000		
F80-7-M			14 AWG	2.50	.28	7.00	.09	2.2	.10	2.5		9/32	7.0	1000
F80-8-M					.31	8.00	.09	2.2	.10	2.5		5/16	8.0	1000
F80-10-M					.39	10.0	.09	2.2	.10	2.5		13/32	10.0	1000
F80-12-M	.47	12.0			.09	2.2	.10	2.5	15/32	12.0	1000			
F80-15-M	.59	15.0			.09	2.2	.10	2.5	19/32	15.0	1000			
F80-18-M	.71	18.0			.09	2.2	.10	2.5	23/32	18.0	1000			
F80-20-M	.79	20.0			.09	2.2	.10	2.5	25/32	20.0	1000			
F81-9-M	12 AWG	4.00			.35	9.00	.11	2.8	.13	3.2	11/32	8.0	1000	
F81-10-M					.39	10.0	.11	2.8	.13	3.2	13/32	10.0	1000	
F81-12-M					.47	12.0	.11	2.8	.13	3.2	15/32	12.0	1000	
F81-15-M			.59	15.0	.11	2.8	.13	3.2	19/32	15.0	1000			
F81-18-M			.71	18.0	.11	2.8	.13	3.2	23/32	18.0	1000			
F81-20-M			.79	20.0	.11	2.8	.13	3.2	25/32	20.0	1000			
F82-10-M			10 AWG	6.00	.39	10.0	.14	3.5	.15	3.9	13/32	10.0	1000	
F82-12-M					.47	12.0	.14	3.5	.15	3.9	15/32	12.0	1000	
F82-15-M					.59	15.0	.14	3.5	.15	3.9	19/32	15.0	1000	
F82-18-M					.71	18.0	.14	3.5	.15	3.9	23/32	18.0	1000	
F82-20-M	.79	20.0			.14	3.5	.15	3.9	25/32	20.0	1000			
F83-12-D	8 AWG	10.0			.47	12.0	.18	4.5	.19	4.9	15/32	12.0	500	
F83-15-D					.59	15.0	.18	4.5	.19	4.9	19/32	15.0	500	
F83-18-D					.71	18.0	.18	4.5	.19	4.9	23/32	18.0	500	
F83-20-D					.79	20.0	.18	4.5	.19	4.9	25/32	20.0	500	
F83-25-D					.98	25.0	.18	4.5	.19	4.9	31/32	25.0	500	
F84-12-TL			6 AWG	16.0	.47	12.0	.23	5.8	.24	6.2	15/32	12.0	250	
F84-15-TL					.59	15.0	.23	5.8	.24	6.2	19/32	15.0	250	
F84-18-TL					.71	18.0	.23	5.8	.24	6.2	23/32	18.0	250	
F84-20-TL					.79	20.0	.23	5.8	.24	6.2	25/32	20.0	250	
F84-25-TL					.98	25.0	.23	5.8	.24	6.2	31/32	25.0	250	
F84-32-TL	1.26	32.0			.23	5.8	.24	6.2	1 1/4	32.0	250			
F85-12-C	4 AWG	25.0			.47	12.0	.29	7.3	.30	7.7	15/32	12.0	100	
F85-15-C					.59	15.0	.29	7.3	.30	7.7	19/32	15.0	100	
F85-18-C					.71	18.0	.29	7.3	.30	7.7	23/32	18.0	100	
F85-25-C					.98	25.0	.29	7.3	.30	7.7	31/32	25.0	100	
F85-32-C			1.26	32.0	.29	7.3	.30	7.7	1 1/4	32.0	100			
F86-18-C			2 AWG	35.0	.71	18.0	.33	8.3	.34	8.7	23/32	18.0	100	
F86-20-C					.79	20.0	.33	8.3	.34	8.7	25/32	20.0	100	
F86-25-C					.98	25.0	.33	8.3	.34	8.7	31/32	25.0	100	
F86-32-C					1.26	32.0	.33	8.3	.34	8.7	1 1/4	32.0	100	
F87-18-C					1 AWG	50.0	.71	18.0	.41	10.3	.43	10.9	23/32	18.0
F87-22-C	.87	22.0					.41	10.3	.43	10.9	7/8	22.0	100	
F87-25-C	.98	25.0					.41	10.3	.43	10.9	31/32	25.0	100	
F87-32-C	1.26	32.0					.41	10.3	.43	10.9	1 1/4	32.0	100	

System Overview

Terminals

Disconnects

Splices

Ferrules

Compression Connectors

Crimping Tools

Mechanical Connectors

Grounding Connectors

Support Products

Technical Info

Index

System Overview

Ferrule Assortment Kits

Terminals



KP-F1 and KP-F2

Disconnects

Splices



KP-FSD1, KP-FSD2 and KP-FSD3

Ferrules

Compression Connectors

Crimping Tools

Mechanical Connectors

Grounding Connectors

Support Products

Technical Info

Index

Part Number	Part Description	Std. Pkg. Qty.
KP-FSD1	Ferrule kit includes: #24 – #18 AWG Insulated DIN Ferrules. Case includes: 30 pieces each of FSD73-6, FSD74-6, FSD75-8, FSD76-8 and FSD77-8.	1
KP-FSD2	Ferrule kit includes: #22 – #14 AWG Insulated DIN ferrules. Case includes: 100 pieces each of FSD76-8, FSD77-8, FSD78-8, 50 pieces each of FSD75-8 and FSD80-8.	1
KP-FSD3	Ferrule kit includes: #12 – #6 AWG Insulated DIN Ferrules. Case includes: 50 pieces of FSD81-10, 20 pieces each of FSD82-12 and FSD83-12, 10 pieces of FSD84-12.	1
KP-F1	Ferrule kit includes: #22 – #14 AWG Non-Insulated Ferrules. Case includes: 500 pieces of F75-6, 400 pieces each of F76-6 and F77-6, 300 pieces of F78-7, 200 pieces of F80-7.	1
KP-F2	Ferrule kit includes: #12 – #6 AWG Non-Insulated Ferrules. Case includes: 150 pieces of F81-9, 100 pieces of F82-10, 80 pieces of F83-12, 40 pieces of F84-12.	1

Ferrule kits do not include crimping tool.

PAN-LUG[™] COMPRESSION CONNECTORS

PANDUIT[®] PAN-LUG[™] Compression Connectors provide permanent terminations for a variety of power and grounding applications, with innovation, highest reliability and lowest installed cost. PANDUIT[®] offers the first and only copper compression lugs and splices that meet Network Equipment-Building Systems (NEBS) Level 3 requirements as tested by Telcordia Technologies. NEBS Level 3 assures that product performance is suitable for equipment applications that demand minimal service interruptions over the life span of the equipment.

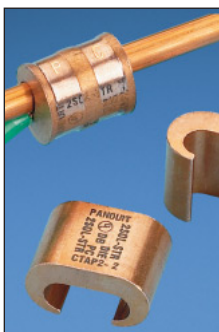

- Functional product information is marked directly on the connector, facilitating the identification, ordering and usage of the compression connector
- Color coded to facilitate quick identification of the proper crimp die
- Made from high strength, high conductivity electrolytic copper and aluminum alloy materials to provide optimum connectivity for power and grounding applications
- UL Listed or Recognized, CSA Certified and tested by Telcordia — meets NEBS Level 3, as noted
- Terminations using PANDUIT[®] PAN-LUG[™] Compression Connectors are also UL Listed and CSA Certified with specified competitor tools
- Wide assortment of manual, controlled cycle, battery operated hydraulic and pneumatic crimping tools for reliable connections at the lowest installed cost

PANDUIT[®] PAN-LUG[™] Compression Connectors are designed for use with many different code and flex conductor types and are available in a broad range of styles and sizes including copper one-hole, two-hole and blank tongue lugs and splices; aluminum one-hole and two-hole lugs and splices; copper CTAP style taps; copper in-line reducing splices; and innovative copper HTAPs with snap-on clear covers. PANDUIT[®] offers a wide assortment of PAN-LUG[™] Power and Grounding Connectors to meet customer needs and today's application requirements.

System Overview

Terminals

Disconnects

Splices

Ferrules

Compression Connectors

Crimping Tools

Mechanical Connectors

Grounding Connectors

Support Products

Technical Info

Index

System Overview

Features and Benefits — *PAN-LUG*™ Compression Connectors

Bolded features are unique to PANDUIT®

Terminals

Copper Lugs

Color coded bands for proper die selection and crimp placement

Easy-to-read, color coded die index numbers for PANDUIT® and specified competitor crimping dies for selection

Made from seamless, high conductivity copper tubing and electro tin plated and burnished to inhibit corrosion

Internally beveled barrel end for easy conductor insertion (types LCCF and LCAF available with flared entry for flex conductor)

Inspection windows available to assure complete conductor insertion

Part number, stud size and conductor size marked on part for easy identification



Aluminum Lugs

Easy-to-read die index numbers for PANDUIT® and specified competitor crimping dies for selection

Part number and conductor size marked on part for easy identification

Made from seamless wrought aluminum and electro tin plated to inhibit corrosion

Color coded end plugs for proper die selection

Crimping areas marked on part for proper crimp placement

Factory pre-filled with oxide inhibitor to prevent oxidation



Ferrules

Copper HTAPs

Easy-to-read, color coded die index number for PANDUIT® crimping dies, legible after crimping, for selection

Conductor sizes for each tap pocket marked on part

Part number and agency listings marked on part for easy identification

Slotted design to reduce installation time when used with PANDUIT® cable ties (included)

Made from high conductivity copper and electro tin plated to inhibit corrosion



Clear Covers for Copper HTAPs

Optically clear to allow 360° inspections

Made from high impact strength self-extinguishing plastic with UL 94V-0 flammability rating and minimum oxygen index of 28

Built-in flanges retain HTAP in cover

Easy to assemble snap-on design

Molded in flash barriers protect against electrical flash over

Retainer clips to hold labels inside cover*. Retainer clips have a write-on surface for manual marking

Corresponding **PANDUIT®** HTAP part number, voltage rating and temperature rating molded into cover half for easy identification

Low profile design minimizes space requirements

Flexible fingers closely conform to conductor preventing foreign objects from entering cover



*Labels shown printed with PANDUIT® LS7 Printer. See [page K29](#)

Mechanical Connectors

Copper In-Line Reducing Splices

Internally beveled barrel end for easy conductor insertion

Easy-to-read, color coded die index numbers for PANDUIT® and specified competitor crimping dies for selection

Made from seamless, high conductivity copper tubing and electro tin plated and burnished to inhibit corrosion

Compact size provides low profile installation

Part number and conductor size and type marked on part for easy identification

Color coded for proper die selection

Inspection windows to assure complete conductor insertion

Crimping areas marked on each barrel for proper crimp placement

Grounding Connectors

Support Products

Technical Info

Index



Selection Guide — PAN-LUG™ Copper Compression Connectors for Copper Code Conductor



Code

	1 Stud Hole Lugs	Short Barrel with Inspection Window	LCAS	Pg. F6,F7
			LCAS-H 45° bent	Pg. F8,F9
			LCAS-F 90° bent	Pg. F10,F11
	Standard Barrel with Inspection Window	LCA	Pg. F12,F13	
		LCA-H 45° bent	Pg. F14,F15	
		LCA-F 90° bent	Pg. F16,F17	
		LCAN narrow tongue	Pg. F18,F19	
		LCA-00 blank tongue	Pg. F20	
	Long Barrel no Inspection Window	LCB	Pg. F21, F22	
		LCB-H 45° bent	Pg. F23, F24	
		LCB-F 90° bent	Pg. F25, F26	
	LCBH with corona relief taper	Pg. F30		
Long Barrel with Inspection Window	LCB-W	Pg. F27		
	LCB-WH 45° bent	Pg. F28		
	LCB-WF 90° bent	Pg. F29		
	Standard Barrel with Inspection Window	LCD	Pg. F31, F32	
		LCD-H 45° bent	Pg. F33, F34	
		LCD-F 90° bent	Pg. F35, F36	
		LCDN narrow tongue	Pg. F37	
	Long Barrel no Inspection Window	LCC	Pg. F40, F41	
		LCC-H 45° bent	Pg. F42, F43	
		LCC-F 90° bent	Pg. F44, F45	
		LCCH with corona relief taper	Pg. F55	
	LCC-00 blank tongue	Pg. F56		
	Long Barrel with Inspection Window	LCC-W	Pg. F46, F47, F48	
		LCC-WH 45° bent	Pg. F49, F50, F51	
		LCC-WF 90° bent	Pg. F52, F53, F54	
LCCN-W narrow tongue		Pg. F54		
LCC-00W blank tongue		Pg. F57		
Butt Splices	Short Barrel	SCSS	Pg. F58	
	Standard Barrel	SCS	Pg. F59	
	Long Barrel	SCL	Pg. F60	
T Splices	SCH with corona relief chamfer	Pg. F61		
	SCT	Pg. F62		
Parallel Splices	PS	Pg. F63		
CTAPs	CTAPF stamped and formed	Pg. F105		
	CTAP heavy duty extrusion	Pg. F106		
	TAPC black covers for CTAP	Pg. F106		

System Overview

Terminals

Disconnects

Splices

Ferrules

Compression Connectors

Crimping Tools

Mechanical Connectors

Grounding Connectors

Support Products

Technical Info

Index

System Overview

Selection Guide — *PAN-LUG*™ Copper Compression Connectors for Copper Code and/or Flex Conductor



Terminals

Disconnects

Splices

Ferrules

Compression Connectors

Crimping Tools

Mechanical Connectors

Grounding Connectors

Support Products

Technical Info

Index



1 Stud Hole Lugs

Standard Barrel with Inspection Window Code & Flex

LCAX	Pg. F64,F65
LCAX-H 45° bent	Pg. F66,F67
LCAX-F 90° bent	Pg. F68,F69
LCAXN narrow tongue	Pg. F70
LCAXN-H 45° bent narrow tongue	Pg. F71
LCAXN-F 90° bent narrow tongue	Pg. F72

Standard Barrel with Inspection Window and Flared Entry Flex

LCAF	Pg. F73,F74
LCAF-H 45° bent	Pg. F75,F76
LCAF-F 90° bent	Pg. F77,F78

Long Barrel with Inspection Window Code & Flex

LCBX	Pg. F79
LCBX-H 45° bent	Pg. F80
LCBX-F 90° bent	Pg. F81



2 Stud Hole Lugs

Standard Barrel with Inspection Window Code & Flex

LCDX	Pg. F82,F83
LCDX-H 45° bent	Pg. F84,F85
LCDX-F 90° bent	Pg. F86,F87
LCDXN narrow tongue	Pg. F88
LCDXN-H 45° bent narrow tongue	Pg. F89
LCDXN-F 90° bent narrow tongue	Pg. F90

Long Barrel no Inspection Window Flared Entry Flex

LCCF	Pg. F95,F96
LCCF-H 45° bent	Pg. F97,F98
LCCF-F 90° bent	Pg. F99,F100

Long Barrel with Inspection Window Code & Flex

LCCX	Pg. F91,F92
LCCX-H 45° bent	Pg. F92,F93
LCCX-F 90° bent	Pg. F94,F95



Butt Splices with Flared Entry Flex

SCSF	Pg. F101
------	----------



Reducing Splices with Inspection Window Code & Flex

RSCK kits with reducing splice and clear heat shrink	Pg. F102,F103
RSC reducing splices	Pg. F104



HTAPs Code & Flex

HTWC kits with HTAPs and clear covers	Pg. F107
HTCT Taps	Pg. F108
CLRCVR clear covers for HTCT taps	Pg. F109

Selection Guide — *PAN-LUG*[™] Aluminum Compression Connectors for Aluminum or Copper Code Conductor



1 Hole Lugs

LAA

Pg. F113



2 Hole Lugs

LAB

Pg. F114



Butt Splices

SA

Pg. F115



Reducing Splices

SAR

Pg. F116



Bi-Metallic Pin Connectors for Aluminum Conductors Only

BPC

Pg. F117



HTAP Taps

HTAP

Pg. F118

TAPC black cover for HTAP taps

Pg. F106



Belleville Washers

CW

Pg. F115, H33



Joint Compounds

CMP

Pg. F118

Part Number System for *PAN-LUG*[™] Compression Lugs

LCD	2/0	—	38	D	F	—	X
Type	Conductor Size		Stud Hole Size	Two Stud Hole Spacing	Tongue Angle		Std. Pkg. Size
			10 = #10	A = .625"	H = 45° Angle		1 = 1
			14 = 1/4"	B = .750"	F = 90° Angle		2 = 2
			56 = 5/16"	C = .875"	No Letter = Straight		3 = 3
			38 = 3/8"	D = 1.0"			5 = 5
			12 = 1/2"	E = 1.25"			6 = 6
			58 = 5/8"	G = 1.5"			X = 10
			34 = 3/4"	J = .5"			E = 20
			78 = 7/8"	K = 2"			Q = 25
			00 = Blank Tongue*	M = 1.375"			L = 50
				P = .688"			
				Q = 1.125"			
				No Letter = 1.75"			

Ex: LCD Lug, Copper Two Hole Standard Barrel

* LCA, LCC and LCD styles only

System Overview

Terminals

Disconnects

Splices

Ferrules

Compression Connectors

Crimping Tools

Mechanical Connectors

Grounding Connectors

Support Products

Technical Info

Index

System Overview



Code Conductor, One-Hole, Short Barrel with Window Lug

For Use with Stranded Copper Conductors

Type LCAS

Terminals

- Short barrel for limited space applications
- Color coded barrels marked with **PANDUIT®** and specified competitor die index numbers for proper crimp die selection
- Inspection window to visually assure full conductor insertion
- Tin plated to inhibit corrosion
- UL Listed for use up to 35KV**, temperature rated 90°C and CSA Certified to 600V when crimped with **PANDUIT®** and specified competitor crimping tools and dies
- **Tested by Telcordia — meets NEBS Level 3**

Disconnects

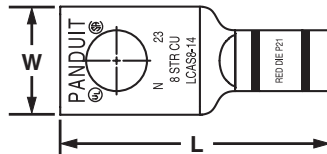

Splices

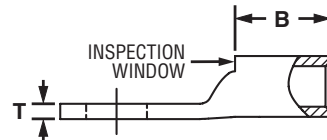

Ferrules

Compression Connectors

Crimping Tools

Mechanical Connectors

Grounding Connectors

Support Products

Technical Info

Index

Part Number	Copper Conductor Size	Stud Hole Size (In.)	Figure Dimensions (In.)				PANDUIT® Color Code	PANDUIT® Die Index No.‡	Burndy Die Index No.‡	T&B Die Index No.‡	Wire Strip Length (In.)	Std. Pkg. Qty.
			W	B	T	L						
LCAS8-10-L	#8 AWG	#10	.41	.42	.08	1.11	Red	P21	49	21	1/2	50
LCAS8-14-L		1/4	.48	.42	.07	1.20	Red	P21	49	21	1/2	50
LCAS8-56-L		5/16	.56	.42	.05	1.32	Red	P21	49	21	1/2	50
LCAS8-38-L		3/8	.60	.42	.05	1.42	Red	P21	49	21	1/2	50
LCAS6-10-L	#6 AWG	#10	.45	.48	.09	1.19	Blue	P24	7	24	9/16	50
LCAS6-14-L		1/4	.48	.48	.08	1.28	Blue	P24	7	24	9/16	50
LCAS6-56-L		5/16	.56	.48	.07	1.40	Blue	P24	7	24	9/16	50
LCAS6-38-L		3/8	.62	.48	.06	1.50	Blue	P24	7	24	9/16	50
LCAS4-10-L	#4 AWG	#10	.55	.53	.09	1.26	Gray	P29	8	29	5/8	50
LCAS4-14-L		1/4	.55	.53	.09	1.35	Gray	P29	8	29	5/8	50
LCAS4-56-L		5/16	.55	.53	.09	1.47	Gray	P29	8	29	5/8	50
LCAS4-38-L		3/8	.62	.53	.07	1.57	Gray	P29	8	29	5/8	50
LCAS2-14-Q	#2 AWG	1/4	.60	.57	.10	1.46	Brown	P33	10	33	5/8	25
LCAS2-56-Q		5/16	.66	.57	.10	1.58	Brown	P33	10	33	5/8	25
LCAS2-38-Q		3/8	.66	.57	.10	1.66	Brown	P33	10	33	5/8	25
LCAS2-12-Q		1/2	.75	.57	.08	1.89	Brown	P33	10	33	5/8	25
LCAS1-14-E	#1 AWG	1/4	.70	.59	.11	1.50	Green	P37	11	37	11/16	20
LCAS1-56-E		5/16	.70	.59	.11	1.63	Green	P37	11	37	11/16	20
LCAS1-38-E		3/8	.70	.59	.11	1.70	Green	P37	11	37	11/16	20
LCAS1-12-E		1/2	.75	.59	.09	1.94	Green	P37	11	37	11/16	20
LCAS1/0-14-X	1/0 AWG	1/4	.76	.66	.12	1.67	Pink	P42	12	42	3/4	10
LCAS1/0-56-X		5/16	.76	.66	.12	1.72	Pink	P42	12	42	3/4	10
LCAS1/0-38-X		3/8	.76	.66	.12	1.80	Pink	P42	12	42	3/4	10
LCAS1/0-12-X		1/2	.80	.66	.12	2.03	Pink	P42	12	42	3/4	10



Code Conductor, One-Hole, Short Barrel with Window Lug (continued)

Part Number	Copper Conductor Size	Stud Hole Size (In.)	Figure Dimensions (In.)				PANDUIT® Color Code	PANDUIT® Die Index No.‡	Burndy Die Index No.‡	T&B Die Index No.‡	Wire Strip Length (In.)	Std. Pkg. Qty.
			W	B	T	L						
LCAS2/0-14-X	2/0 AWG	1/4	.85	.72	.13	1.82	Black	P45	13	45	3/4	10
LCAS2/0-56-X		5/16	.85	.72	.13	1.82	Black	P45	13	45	3/4	10
LCAS2/0-38-X		3/8	.85	.72	.13	1.89	Black	P45	13	45	3/4	10
LCAS2/0-12-X		1/2	.85	.72	.13	2.14	Black	P45	13	45	3/4	10
LCAS3/0-14-X	3/0 AWG	1/4	.96	.83	.13	1.97	Orange	P50	14	50	7/8	10
LCAS3/0-56-X		5/16	.96	.83	.13	1.97	Orange	P50	14	50	7/8	10
LCAS3/0-38-X		3/8	.96	.83	.13	2.03	Orange	P50	14	50	7/8	10
LCAS3/0-12-X		1/2	.96	.83	.13	2.28	Orange	P50	14	50	7/8	10
LCAS4/0-14-X	4/0 AWG	1/4	1.06	.91	.14	2.08	Purple	P54	15	54	1	10
LCAS4/0-56-X		5/16	1.06	.91	.14	2.10	Purple	P54	15	54	5/16	10
LCAS4/0-38-X		3/8	1.06	.91	.14	2.17	Purple	P54	15	54	1	10
LCAS4/0-12-X		1/2	1.06	.91	.14	2.40	Purple	P54	15	54	1	10
LCAS250-14-X	250 kcmil	1/4	1.17	1.03	.14	2.25	Yellow	P62	16	62	1 1/8	10
LCAS250-56-X		5/16	1.17	1.03	.14	2.25	Yellow	P62	16	62	1 1/8	10
LCAS250-38-X		3/8	1.17	1.03	.14	2.32	Yellow	P62	16	62	1 1/8	10
LCAS250-12-X		1/2	1.17	1.03	.14	2.56	Yellow	P62	16	62	1 1/8	10

‡See [pages L6, L7](#) in Technical Info section for tool and die information.

**Consult cable manufacturer for voltage stress relief instructions with applications greater than 2000 volts.

System Overview

Terminals

Disconnects

Splices

Ferrules

Compression Connectors

Crimping Tools

Mechanical Connectors

Grounding Connectors

Support Products

Technical Info

Index

System Overview



Code Conductor, One-Hole, Short Barrel with Window Lug, 45° Angle

Terminals

For Use with Stranded Copper Conductors

Type LCAS-H

- Short barrel for limited space applications
- Color coded barrels marked with **PANDUIT®** and specified competitor die index numbers for proper crimp die selection
- Inspection window to visually assure full conductor insertion
- Tin plated to inhibit corrosion
- UL Listed for use up to 35KV**, temperature rated 90°C and CSA Certified to 600V when crimped with **PANDUIT®** and specified competitor crimping tools and dies
- Tested by Telcordia — meets NEBS Level 3

Disconnects

Splices

Ferrules

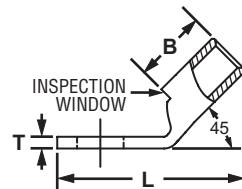
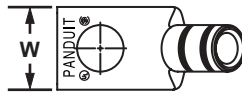

Part Number	Copper Conductor Size	Stud Hole Size (In.)	Figure Dimensions (In.)				PANDUIT® Color Code	PANDUIT® Die Index No.‡	Burndy Die Index No.‡	T&B Die Index No.‡	Wire Strip Length (In.)	Std. Pkg. Qty.
			W	B	T	L						
LCAS8-10H-L	#8 AWG	#10	.41	.42	.08	1.00	Red	P21	49	21	1/2	50
LCAS8-14H-L		1/4	.48	.42	.07	1.09	Red	P21	49	21	1/2	50
LCAS8-56H-L		5/16	.56	.42	.05	1.20	Red	P21	49	21	1/2	50
LCAS8-38H-L		3/8	.60	.42	.05	1.30	Red	P21	49	21	1/2	50
LCAS6-10H-L	#6 AWG	#10	.45	.48	.09	1.06	Blue	P24	7	24	9/16	50
LCAS6-14H-L		1/4	.48	.48	.08	1.14	Blue	P24	7	24	9/16	50
LCAS6-56H-L		5/16	.56	.48	.07	1.26	Blue	P24	7	24	9/16	50
LCAS6-38H-L		3/8	.62	.48	.06	1.35	Blue	P24	7	24	9/16	50
LCAS4-10H-L	#4 AWG	#10	.55	.53	.09	1.12	Gray	P29	8	29	5/8	50
LCAS4-14H-L		1/4	.55	.53	.09	1.21	Gray	P29	8	29	5/8	50
LCAS4-56H-L		5/16	.55	.53	.09	1.33	Gray	P29	8	29	5/8	50
LCAS4-38H-L		3/8	.62	.53	.07	1.42	Gray	P29	8	29	5/8	50
LCAS2-14H-Q	#2 AWG	1/4	.60	.57	.10	1.27	Brown	P33	10	33	5/8	25
LCAS2-56H-Q		5/16	.66	.57	.10	1.39	Brown	P33	10	33	5/8	25
LCAS2-38H-Q		3/8	.66	.57	.10	1.46	Brown	P33	10	33	5/8	25
LCAS2-12H-Q		1/2	.75	.57	.08	1.68	Brown	P33	10	33	5/8	25
LCAS1-14H-E	#1 AWG	1/4	.70	.59	.11	1.29	Green	P37	11	37	11/16	20
LCAS1-56H-E		5/16	.70	.59	.11	1.42	Green	P37	11	37	11/16	20
LCAS1-38H-E		3/8	.70	.59	.11	1.49	Green	P37	11	37	11/16	20
LCAS1-12H-E		1/2	.75	.59	.09	1.73	Green	P37	11	37	11/16	20
LCAS1/0-14H-X	1/0 AWG	1/4	.76	.66	.12	1.43	Pink	P42	12	42	3/4	10
LCAS1/0-56H-X		5/16	.76	.66	.12	1.49	Pink	P42	12	42	3/4	10
LCAS1/0-38H-X		3/8	.76	.66	.12	1.56	Pink	P42	12	42	3/4	10
LCAS1/0-12H-X		1/2	.80	.66	.12	1.79	Pink	P42	12	42	3/4	10

Technical Info

Index



Code Conductor, One-Hole, Short Barrel with Window Lug, 45° Angle (continued)

Part Number	Copper Conductor Size	Stud Hole Size (In.)	Figure Dimensions (In.)				PANDUIT® Color Code	PANDUIT® Die Index No.‡	Burndy Die Index No.‡	T&B Die Index No.‡	Wire Strip Length (In.)	Std. Pkg. Qty.
			W	B	T	L						
LCAS2/0-14H-X	2/0 AWG	1/4	.85	.72	.13	1.58	Black	P45	13	45	3/4	10
LCAS2/0-56H-X		5/16	.85	.72	.13	1.58	Black	P45	13	45	3/4	10
LCAS2/0-38H-X		3/8	.85	.72	.13	1.64	Black	P45	13	45	3/4	10
LCAS2/0-12H-X		1/2	.85	.72	.13	1.89	Black	P45	13	45	3/4	10
LCAS3/0-14H-X	3/0 AWG	1/4	.96	.83	.13	1.68	Orange	P50	14	50	7/8	10
LCAS3/0-56H-X		5/16	.96	.83	.13	1.68	Orange	P50	14	50	7/8	10
LCAS3/0-38H-X		3/8	.96	.83	.13	1.74	Orange	P50	14	50	7/8	10
LCAS3/0-12H-X		1/2	.96	.83	.13	1.99	Orange	P50	14	50	7/8	10
LCAS4/0-14H-X	4/0 AWG	1/4	1.06	.91	.14	1.77	Purple	P54	15	54	1	10
LCAS4/0-56H-X		5/16	1.06	.91	.14	1.78	Purple	P54	15	54	1	10
LCAS4/0-38H-X		3/8	1.06	.91	.14	1.85	Purple	P54	15	54	1	10
LCAS4/0-12H-X		1/2	1.06	.91	.14	2.08	Purple	P54	15	54	1	10
LCAS250-14H-X	250 kcmil	1/4	1.17	1.03	.14	1.89	Yellow	P62	16	62	1 1/8	10
LCAS250-56H-X		5/16	1.17	1.03	.14	1.90	Yellow	P62	16	62	1 1/8	10
LCAS250-38H-X		3/8	1.17	1.03	.14	1.97	Yellow	P62	16	62	1 1/8	10
LCAS250-12H-X		1/2	1.17	1.03	.14	2.20	Yellow	P62	16	62	1 1/8	10

‡See [pages L6, L7](#) in Technical Info section for tool and die information.

**Consult cable manufacturer for voltage stress relief instructions with applications greater than 2000 volts.

System Overview

Terminals

Disconnects

Splices

Ferrules

Compression Connectors

Crimping Tools

Mechanical Connectors

Grounding Connectors

Support Products

Technical Info

Index

PANDUIT® TERMINATION SOLUTIONS

System Overview



Code Conductor, One-Hole, Short Barrel with Window Lug, 90° Angle

Terminals

For Use with Stranded Copper Conductors

Type LCAS-F

- Short barrel for limited space applications
- Color coded barrels marked with **PANDUIT®** and specified competitor die index numbers for proper crimp die selection
- Inspection window to visually assure full conductor insertion
- Tin plated to inhibit corrosion
- UL Listed for use up to 35KV**, temperature rated 90°C and CSA Certified to 600V when crimped with **PANDUIT®** and specified competitor crimping tools and dies
- **Tested by Telcordia — meets NEBS Level 3**

Disconnects

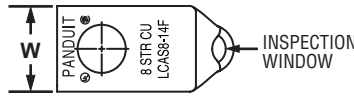

Splices

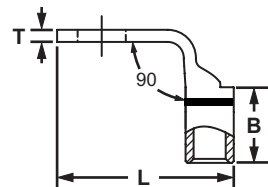

Ferrules

Part Number	Copper Conductor Size	Stud Hole Size (In.)	Figure Dimensions (In.)				PANDUIT® Color Code	PANDUIT® Die Index No.‡	Burdny Die Index No.‡	T&B Die Index No.‡	Wire Strip Length (In.)	Std. Pkg. Qty.
			W	B	T	L						
LCAS8-10F-L	#8 AWG	#10	.41	.42	.08	.90	Red	P21	49	21	1/2	50
LCAS8-14F-L		1/4	.48	.42	.07	.99	Red	P21	49	21	1/2	50
LCAS8-56F-L		5/16	.56	.42	.05	1.11	Red	P21	49	21	1/2	50
LCAS8-38F-L		3/8	.60	.42	.05	1.21	Red	P21	49	21	1/2	50
LCAS6-10F-L	#6 AWG	#10	.45	.48	.09	.94	Blue	P24	7	24	9/16	50
LCAS6-14F-L		1/4	.48	.48	.08	1.03	Blue	P24	7	24	9/16	50
LCAS6-56F-L		5/16	.56	.48	.07	1.15	Blue	P24	7	24	9/16	50
LCAS6-38F-L		3/8	.62	.48	.06	1.25	Blue	P24	7	24	9/16	50
LCAS4-10F-L	#4 AWG	#10	.55	.53	.09	1.03	Gray	P29	8	29	5/8	50
LCAS4-14F-L		1/4	.55	.53	.09	1.12	Gray	P29	8	29	5/8	50
LCAS4-56F-L		5/16	.55	.53	.09	1.24	Gray	P29	8	29	5/8	50
LCAS4-38F-L		3/8	.62	.53	.07	1.34	Gray	P29	8	29	5/8	50
LCAS2-14F-Q	#2 AWG	1/4	.60	.57	.10	1.24	Brown	P33	10	33	5/8	25
LCAS2-56F-Q		5/16	.66	.57	.10	1.36	Brown	P33	10	33	5/8	25
LCAS2-38F-Q		3/8	.66	.57	.10	1.44	Brown	P33	10	33	5/8	25
LCAS2-12F-Q		1/2	.75	.57	.08	1.67	Brown	P33	10	33	5/8	25
LCAS1-14F-E	#1 AWG	1/4	.70	.59	.11	1.31	Green	P37	11	37	11/16	20
LCAS1-56F-E		5/16	.70	.59	.11	1.44	Green	P37	11	37	11/16	20
LCAS1-38F-E		3/8	.70	.59	.11	1.51	Green	P37	11	37	11/16	20
LCAS1-12F-E		1/2	.75	.59	.09	1.75	Green	P37	11	37	11/16	20
LCAS1/0-14F-X	1/0 AWG	1/4	.76	.66	.12	1.45	Pink	P42	12	42	3/4	10
LCAS1/0-56F-X		5/16	.76	.66	.12	1.51	Pink	P42	12	42	3/4	10
LCAS1/0-38F-X		3/8	.76	.66	.12	1.58	Pink	P42	12	42	3/4	10
LCAS1/0-12F-X		1/2	.80	.66	.12	1.82	Pink	P42	12	42	3/4	10

Technical Info

Index



Code Conductor, One-Hole, Short Barrel with Window Lug, 90° Angle (continued)

Part Number	Copper Conductor Size	Stud Hole Size (In.)	Figure Dimensions (In.)				PANDUIT® Color Code	PANDUIT® Die Index No.‡	Burndy Die Index No.‡	T&B Die Index No.‡	Wire Strip Length (In.)	Std. Pkg. Qty.
			W	B	T	L						
LCAS2/0-14F-X	2/0 AWG	1/4	.85	.72	.13	1.59	Black	P45	13	45	3/4	10
LCAS2/0-56F-X		5/16	.85	.72	.13	1.59	Black	P45	13	45	3/4	10
LCAS2/0-38F-X		3/8	.85	.72	.13	1.66	Black	P45	13	45	3/4	10
LCAS2/0-12F-X		1/2	.85	.72	.13	1.91	Black	P45	13	45	3/4	10
LCAS3/0-14F-X	3/0 AWG	1/4	.96	.83	.13	1.67	Orange	P50	14	50	7/8	10
LCAS3/0-56F-X		5/16	.96	.83	.13	1.67	Orange	P50	14	50	7/8	10
LCAS3/0-38F-X		3/8	.96	.83	.13	1.73	Orange	P50	14	50	7/8	10
LCAS3/0-12F-X		1/2	.96	.83	.13	1.98	Orange	P50	14	50	7/8	10
LCAS4/0-14F-X	4/0 AWG	1/4	1.06	.91	.14	1.75	Purple	P54	15	54	1	10
LCAS4/0-56F-X		5/16	1.06	.91	.14	1.77	Purple	P54	15	54	1	10
LCAS4/0-38F-X		3/8	1.06	.91	.14	1.84	Purple	P54	15	54	1	10
LCAS4/0-12F-X		1/2	1.06	.91	.14	2.07	Purple	P54	15	54	1	10
LCAS250-14F-X	250 kcmil	1/4	1.17	1.03	.14	1.82	Yellow	P62	16	62	1 1/8	10
LCAS250-56F-X		5/16	1.17	1.03	.14	1.83	Yellow	P62	16	62	1 1/8	10
LCAS250-38F-X		3/8	1.17	1.03	.14	1.90	Yellow	P62	16	62	1 1/8	10
LCAS250-12F-X		1/2	1.17	1.03	.14	2.13	Yellow	P62	16	62	1 1/8	10

‡See [pages L6, L7](#) in Technical Info section for tool and die information.

**Consult cable manufacturer for voltage stress relief instructions with applications greater than 2000 volts.

System Overview

Terminals

Disconnects

Splices

Ferrules

Compression Connectors

Crimping Tools

Mechanical Connectors

Grounding Connectors

Support Products

Technical Info

Index

PANDUIT® TERMINATION SOLUTIONS

System Overview



Code Conductor, One-Hole, Standard Barrel with Window Lug

For Use with Stranded Copper Conductors

Type LCA

Terminals

- Color coded barrels marked with **PANDUIT®** and specified competitor die index numbers for proper crimp die selection
- Inspection window to visually assure full conductor insertion
- Tin plated to inhibit corrosion
- UL Listed and CSA Certified for wire range-taking capability when crimped with **PANDUIT® UNI-DIE™** dieless crimping tools ‡
- **Tested by Telcordia — meets NEBS Level 3**

Disconnects

- UL Listed for use up to 35KV**, temperature rated 90°C and CSA Certified to 600V when crimped with **PANDUIT®** and specified competitor crimping tools and dies

Splices

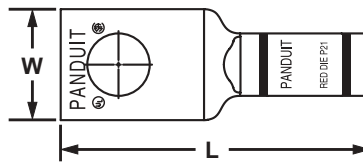

Ferrules

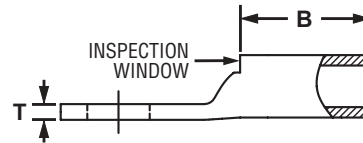

Compression Connectors

Crimping Tools

Mechanical Connectors

Grounding Connectors

Support Products

Technical Info

Index

Part Number	Copper Conductor Size	Stud Hole Size (In.)	Figure Dimensions (In.)				PANDUIT® Color Code	PANDUIT® Die Index No. ‡	Burndy Die Index No. ‡	T&B Die Index No. ‡	Wire Strip Length (In.)	Std. Pkg. Qty.
			W	B	T	L						
LCA10-10-L*		#10	.38	.38	.06	1.07	—	—	—	—	7/16	50
LCA10-14-L*	#14 – #10 AWG STR,	1/4	.42	.38	.05	1.16	—	—	—	—	7/16	50
LCA10-56-L*	#12 – #10 AWG SOL	5/16	.54	.38	.04	1.28	—	—	—	—	7/16	50
LCA10-38-L*		3/8	.56	.38	.04	1.38	—	—	—	—	7/16	50
LCA8-10-L	#8 AWG	#10	.41	.56	.08	1.25	Red	P21	49	21	5/8	50
LCA8-14-L		1/4	.48	.56	.07	1.34	Red	P21	49	21	5/8	50
LCA8-56-L		5/16	.56	.56	.05	1.46	Red	P21	49	21	5/8	50
LCA8-38-L		3/8	.60	.56	.05	1.56	Red	P21	49	21	5/8	50
LCA6-10-L	#6 AWG	#10	.45	.81	.09	1.52	Blue	P24	7	24	7/8	50
LCA6-14-L		1/4	.48	.81	.08	1.61	Blue	P24	7	24	7/8	50
LCA6-56-L		5/16	.56	.81	.07	1.73	Blue	P24	7	24	7/8	50
LCA6-38-L		3/8	.62	.81	.06	1.83	Blue	P24	7	24	7/8	50
LCA4-10-L	#4 – #3 AWG STR, #2 AWG SOL	#10	.55	.81	.09	1.54	Gray	P29	8	29	7/8	50
LCA4-14-L		1/4	.55	.81	.09	1.63	Gray	P29	8	29	7/8	50
LCA4-56-L		5/16	.55	.81	.09	1.75	Gray	P29	8	29	7/8	50
LCA4-38-L		3/8	.62	.81	.07	1.85	Gray	P29	8	29	7/8	50
LCA2-14-Q	#2 AWG	1/4	.60	.88	.10	1.77	Brown	P33	10	33	15/16	25
LCA2-56-Q		5/16	.66	.88	.10	1.90	Brown	P33	10	33	15/16	25
LCA2-38-Q		3/8	.66	.88	.10	1.97	Brown	P33	10	33	15/16	25
LCA2-12-Q		1/2	.75	.88	.08	2.21	Brown	P33	10	33	15/16	25
LCA1-14-E	#1 AWG	1/4	.70	.88	.11	1.79	Green	P37	11	37	15/16	20
LCA1-56-E		5/16	.70	.88	.11	1.92	Green	P37	11	37	15/16	20
LCA1-38-E		3/8	.70	.88	.11	1.99	Green	P37	11	37	15/16	20
LCA1-12-E		1/2	.75	.88	.09	2.23	Green	P37	11	37	15/16	20

PANDUIT® TERMINATION SOLUTIONS



Code Conductor, One-Hole, Standard Barrel with Window Lug (continued)

Part Number	Copper Conductor Size	Stud Hole Size (In.)	Figure Dimensions (In.)				PANDUIT® Color Code	PANDUIT® Die Index No.‡	Burndy Die Index No.‡	T&B Die Index No.‡	Wire Strip Length (In.)	Std. Pkg. Qty.
			W	B	T	L						
LCA1/0-14-X	1/0 AWG	1/4	.76	.94	.12	1.95	Pink	P42	12	42	1	10
LCA1/0-56-X		5/16	.76	.94	.12	2.00	Pink	P42	12	42	1	10
LCA1/0-38-X		3/8	.76	.94	.12	2.08	Pink	P42	12	42	1	10
LCA1/0-12-X		1/2	.80	.94	.12	2.31	Pink	P42	12	42	1	10
LCA2/0-14-X	2/0 AWG	1/4	.85	.98	.13	2.09	Black	P45	13	45	1 1/16	10
LCA2/0-56-X		5/16	.85	.98	.13	2.09	Black	P45	13	45	1 1/16	10
LCA2/0-38-X		3/8	.85	.98	.13	2.15	Black	P45	13	45	1 1/16	10
LCA2/0-12-X		1/2	.85	.98	.13	2.40	Black	P45	13	45	1 1/16	10
LCA3/0-14-X	3/0 AWG	1/4	.96	1.14	.13	2.28	Orange	P50	14	50	1 3/16	10
LCA3/0-56-X		5/16	.96	1.14	.13	2.28	Orange	P50	14	50	1 3/16	10
LCA3/0-38-X		3/8	.96	1.14	.13	2.34	Orange	P50	14	50	1 3/16	10
LCA3/0-12-X		1/2	.96	1.14	.13	2.59	Orange	P50	14	50	1 3/16	10
LCA4/0-14-X	4/0 AWG	1/4	1.06	1.19	.14	2.36	Purple	P54	15	54	1 1/4	10
LCA4/0-56-X		5/16	1.06	1.19	.14	2.38	Purple	P54	15	54	1 1/4	10
LCA4/0-38-X		3/8	1.06	1.19	.14	2.45	Purple	P54	15	54	1 1/4	10
LCA4/0-12-X		1/2	1.06	1.19	.14	2.68	Purple	P54	15	54	1 1/4	10
LCA250-14-X	250 kcmil	1/4	1.17	1.25	.14	2.47	Yellow	P62	16	62	1 5/16	10
LCA250-56-X		5/16	1.17	1.25	.14	2.48	Yellow	P62	16	62	1 5/16	10
LCA250-38-X		3/8	1.17	1.25	.14	2.55	Yellow	P62	16	62	1 5/16	10
LCA250-12-X		1/2	1.17	1.25	.14	2.78	Yellow	P62	16	62	1 5/16	10
LCA300-56-X	300 kcmil	5/16	1.19	1.44	.16	2.94	White	P66	17	66	1 1/2	10
LCA300-38-X		3/8	1.19	1.44	.16	2.94	White	P66	17	66	1 1/2	10
LCA300-12-X		1/2	1.19	1.44	.16	3.05	White	P66	17	66	1 1/2	10
LCA300-58-X		5/8	1.19	1.44	.16	3.26	White	P66	17	66	1 1/2	10
LCA300-78-X		7/8	1.19	1.44	.16	3.70	White	P66	17	66	1 1/2	10
LCA350-38-X	350 kcmil	3/8	1.28	1.44	.17	2.98	Red	P71	18	71	1 1/2	10
LCA350-12-X		1/2	1.28	1.44	.17	3.09	Red	P71	18	71	1 1/2	10
LCA350-58-X		5/8	1.28	1.44	.17	3.30	Red	P71	18	71	1 1/2	10
LCA350-78-X		7/8	1.28	1.44	.17	3.74	Red	P71	18	71	1 1/2	10
LCA400-38-6	400 kcmil	3/8	1.39	1.50	.18	3.22	Blue	P76	19	76	1 9/16	6
LCA400-12-6		1/2	1.39	1.50	.18	3.22	Blue	P76	19	76	1 9/16	6
LCA400-58-6		5/8	1.39	1.50	.18	3.43	Blue	P76	19	76	1 9/16	6
LCA400-78-6		7/8	1.39	1.50	.18	3.82	Blue	P76	19	76	1 9/16	6
LCA500-38-6	500 kcmil	3/8	1.54	1.75	.22	3.39	Brown	P87	20	87	1 13/16	6
LCA500-12-6		1/2	1.54	1.75	.22	3.55	Brown	P87	20	87	1 13/16	6
LCA500-58-6		5/8	1.54	1.75	.22	3.76	Brown	P87	20	87	1 13/16	6
LCA500-34-6		3/4	1.54	1.75	.22	3.90	Brown	P87	20	87	1 13/16	6
LCA500-78-6		7/8	1.54	1.75	.22	4.15	Brown	P87	20	87	1 13/16	6
LCA500-1-6		1	1.54	1.75	.22	4.27	Brown	P87	20	87	1 13/16	6
LCA600-12-6	600 kcmil	1/2	1.70	1.75	.26	4.20	Green	P94	22	94	1 13/16	6
LCA600-58-6		5/8	1.70	1.75	.26	4.20	Green	P94	22	94	1 13/16	6
LCA600-78-6		7/8	1.70	1.75	.26	4.20	Green	P94	22	94	1 13/16	6
LCA750-58-6	750 kcmil	5/8	1.89	1.88	.26	4.59	Black	P106	24	106	1 15/16	6

‡See [pages L8, L9 and L10, L11](#) in Technical Info section for tool and die information.

*Not tested to NEBS Level 3 requirements.

**Consult cable manufacturer for voltage stress relief instructions with applications greater than 2000 volts.

System Overview

Terminals

Disconnects

Splices

Ferrules

Compression Connectors

Crimping Tools

Mechanical Connectors

Grounding Connectors

Support Products

Technical Info

Index

System Overview



Code Conductor, One-Hole, Standard Barrel with Window Lug, 45° Angle

For Use with Stranded Copper Conductors

Type LCA-H

- Color coded barrels marked with **PANDUIT®** and specified competitor die index numbers for proper crimp die selection
- Inspection window to visually assure full conductor insertion
- Tin plated to inhibit corrosion
- UL Listed for use up to 35KV**, temperature rated 90°C and CSA Certified to 600V when crimped with **PANDUIT®** and specified competitor crimping tools and dies
- UL Listed and CSA Certified for wire range-taking capability when crimped with **PANDUIT® UNI-DIE™** dieless crimping tools ‡
- Tested by Telcordia — meets NEBS Level 3

Terminals

Disconnects

Splices

Ferrules

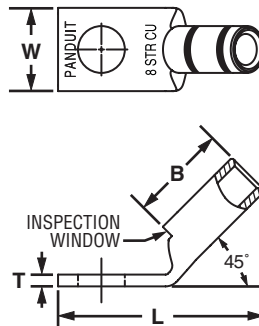

Compression Connectors

Crimping Tools

Mechanical Connectors

Grounding Connectors

Support Products

Technical Info

Index

Part Number	Copper Conductor Size	Stud Hole Size (In.)	Figure Dimensions (In.)				PANDUIT® Color Code	PANDUIT® Die Index No.‡	Burndy Die Index No.‡	T&B Die Index No.‡	Wire Strip Length (In.)	Std. Pkg. Qty.
			W	B	T	L						
LCA10-14H-L*	#14 – #10 AWG STR, #12 – #10 AWG SOL	1/4	.42	.38	.05	1.05	—	—	—	—	7/16	50
LCA8-10H-L	#8 AWG	#10	.41	.56	.08	1.10	Red	P21	—	21	5/8	50
LCA8-14H-L		1/4	.48	.56	.07	1.19	Red	P21	—	21	5/8	50
LCA8-56H-L		5/16	.56	.56	.05	1.30	Red	P21	—	21	5/8	50
LCA8-38H-L		3/8	.60	.56	.05	1.40	Red	P21	—	21	5/8	50
LCA6-10H-L	#6 AWG	#10	.45	.81	.09	1.29	Blue	P24	7	24	7/8	50
LCA6-14H-L		1/4	.48	.81	.08	1.38	Blue	P24	7	24	7/8	50
LCA6-56H-L		5/16	.56	.81	.07	1.49	Blue	P24	7	24	7/8	50
LCA6-38H-L		3/8	.62	.81	.06	1.59	Blue	P24	7	24	7/8	50
LCA4-10H-L	#4 – #3 AWG STR, #2 AWG SOL	#10	.55	.81	.09	1.31	Gray	P29	8	29	7/8	50
LCA4-14H-L		1/4	.55	.81	.09	1.40	Gray	P29	8	29	7/8	50
LCA4-56H-L		5/16	.55	.81	.09	1.52	Gray	P29	8	29	7/8	50
LCA4-38H-L		3/8	.62	.81	.07	1.61	Gray	P29	8	29	7/8	50
LCA2-14H-Q	#2 AWG	1/4	.60	.88	.10	1.49	Brown	P33	10	33	15/16	25
LCA2-56H-Q		5/16	.66	.88	.10	1.61	Brown	P33	10	33	15/16	25
LCA2-38H-Q		3/8	.66	.88	.10	1.68	Brown	P33	10	33	15/16	25
LCA2-12H-Q		1/2	.75	.88	.08	1.90	Brown	P33	10	33	15/16	25
LCA1-14H-E	#1 AWG	1/4	.70	.88	.11	1.50	Green	P37	11	37	15/16	20
LCA1-56H-E		5/16	.70	.88	.11	1.62	Green	P37	11	37	15/16	20
LCA1-38H-E		3/8	.70	.88	.11	1.70	Green	P37	11	37	15/16	20
LCA1-12H-E		1/2	.75	.88	.09	1.93	Green	P37	11	37	15/16	20

PANDUIT® TERMINATION SOLUTIONS



Code Conductor, One-Hole, Standard Barrel with Window Lug, 45° Angle (continued)

Part Number	Copper Conductor Size	Stud Hole Size (In.)	Figure Dimensions (In.)				PANDUIT® Color Code	PANDUIT® Die Index No.‡	Burndy Die Index No.‡	T&B Die Index No.‡	Wire Strip Length (In.)	Std. Pkg. Qty.
			W	B	T	L						
LCA1/0-14H-X	1/0 AWG	1/4	.76	.94	.12	1.63	Pink	P42	12	42	1	10
LCA1/0-56H-X		5/16	.76	.94	.12	1.69	Pink	P42	12	42	1	10
LCA1/0-38H-X		3/8	.76	.94	.12	1.76	Pink	P42	12	42	1	10
LCA1/0-12H-X		1/2	.80	.94	.12	1.99	Pink	P42	12	42	1	10
LCA2/0-14H-X	2/0 AWG	1/4	.85	.98	.13	1.77	Black	P45	13	45	1 1/16	10
LCA2/0-56H-X		5/16	.85	.98	.13	1.77	Black	P45	13	45	1 1/16	10
LCA2/0-38H-X		3/8	.85	.98	.13	1.83	Black	P45	13	45	1 1/16	10
LCA2/0-12H-X		1/2	.85	.98	.13	2.08	Black	P45	13	45	1 1/16	10
LCA2/0-34H-X	3/0 AWG	3/4	1.06	.98	.09	2.66	Black	P45	13	45	1 1/16	10
LCA3/0-14H-X		1/4	.96	1.14	.13	1.90	Orange	P50	14	50	1 3/16	10
LCA3/0-56H-X		5/16	.96	1.14	.13	1.90	Orange	P50	14	50	1 3/16	10
LCA3/0-38H-X		3/8	.96	1.14	.13	1.96	Orange	P50	14	50	1 3/16	10
LCA3/0-12H-X	4/0 AWG	1/2	.96	1.14	.13	2.21	Orange	P50	14	50	1 3/16	10
LCA4/0-14H-X		1/4	1.06	1.19	.14	1.97	Purple	P54	15	54	1 1/4	10
LCA4/0-56H-X		5/16	1.06	1.19	.14	1.98	Purple	P54	15	54	1 1/4	10
LCA4/0-38H-X		3/8	1.06	1.19	.14	2.05	Purple	P54	15	54	1 1/4	10
LCA4/0-12H-X	250 kcmil	1/2	1.06	1.19	.14	2.28	Purple	P54	15	54	1 1/4	10
LCA250-14H-X		1/4	1.17	1.25	.14	2.05	Yellow	P62	16	62	1 5/16	10
LCA250-56H-X		5/16	1.17	1.25	.14	2.06	Yellow	P62	16	62	1 5/16	10
LCA250-38H-X		3/8	1.17	1.25	.14	2.13	Yellow	P62	16	62	1 5/16	10
LCA250-12H-X	300 kcmil	1/2	1.17	1.25	.14	2.36	Yellow	P62	16	62	1 5/16	10
LCA300-56H-X		5/16	1.19	1.44	.16	2.55	White	P66	17	66	1 1/2	10
LCA300-38H-X		3/8	1.19	1.44	.16	2.55	White	P66	17	66	1 1/2	10
LCA300-12H-X		1/2	1.19	1.44	.16	2.66	White	P66	17	66	1 1/2	10
LCA300-58H-X	350 kcmil	5/8	1.19	1.44	.16	2.87	White	P66	17	66	1 1/2	10
LCA300-78H-X		7/8	1.19	1.44	.16	3.31	White	P66	17	66	1 1/2	10
LCA350-38H-X		3/8	1.28	1.44	.17	2.59	Red	P71	18	71	1 1/2	10
LCA350-12H-X		1/2	1.28	1.44	.17	2.70	Red	P71	18	71	1 1/2	10
LCA350-58H-X	400 kcmil	5/8	1.28	1.44	.17	2.91	Red	P71	18	71	1 1/2	10
LCA350-78H-X		7/8	1.28	1.44	.17	3.35	Red	P71	18	71	1 1/2	10
LCA400-38H-6		3/8	1.39	1.50	.18	2.85	Blue	P76	19	76	1 9/16	6
LCA400-12H-6		1/2	1.39	1.50	.18	2.85	Blue	P76	19	76	1 9/16	6
LCA400-58H-6	500 kcmil	5/8	1.39	1.50	.18	3.06	Blue	P76	19	76	1 9/16	6
LCA400-78H-6		7/8	1.39	1.50	.18	3.45	Blue	P76	19	76	1 9/16	6
LCA500-38H-6		3/8	1.54	1.75	.22	2.94	Brown	P87	20	87	1 13/16	6
LCA500-12H-6		1/2	1.54	1.75	.22	3.10	Brown	P87	20	87	1 13/16	6
LCA500-58H-6	600 kcmil	5/8	1.54	1.75	.22	3.31	Brown	P87	20	87	1 13/16	6
LCA500-34H-6		3/4	1.54	1.75	.22	3.45	Brown	P87	20	87	1 13/16	6
LCA500-78H-6		7/8	1.54	1.75	.22	3.70	Brown	P87	20	87	1 13/16	6
LCA500-1H-6		1	1.54	1.75	.22	3.82	Brown	P87	20	87	1 13/16	6
LCA600-12H-6	600 kcmil	1/2	1.70	1.75	.26	3.76	Green	P94	22	94	1 13/16	6
LCA600-58H-6		5/8	1.70	1.75	.26	3.76	Green	P94	22	94	1 13/16	6
LCA600-78H-6		7/8	1.70	1.75	.26	3.76	Green	P94	22	94	1 13/16	6

‡See [pages L8, L9 and L10, L11](#) in Technical Info section for tool and die information.

*Not tested to NEBS Level 3 requirements.

**Consult cable manufacturer for voltage stress relief instructions with applications greater than 2000 volts.

System Overview

Terminals

Disconnects

Splices

Ferrules

Compression Connectors

Crimping Tools

Mechanical Connectors

Grounding Connectors

Support Products

Technical Info

Index

PANDUIT® TERMINATION SOLUTIONS

System Overview



Code Conductor, One-Hole, Standard Barrel with Window Lug, 90° Angle

For Use with Stranded Copper Conductors

Type LCA-F

- Color coded barrels marked with **PANDUIT®** and specified competitor die index numbers for proper crimp die selection
- Inspection window to visually assure full conductor insertion
- Tin plated to inhibit corrosion

- UL Listed for use up to 35KV**, temperature rated 90°C and CSA Certified to 600V when crimped with **PANDUIT®** and specified competitor crimping tools and dies
- UL Listed and CSA Certified for wire range-taking capability when crimped with **PANDUIT® UNI-DIE™** dieless crimping tools ‡
- Tested by Telcordia — meets NEBS Level 3

Disconnects

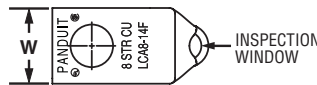

Splices

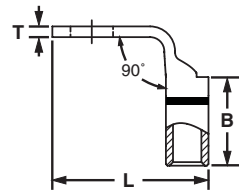

Ferrules

Compression Connectors

Crimping Tools

Mechanical Connectors

Grounding Connectors

Support Products

Technical Info

Index

Part Number	Copper Conductor Size	Stud Hole Size (In.)	Figure Dimensions (In.)				PANDUIT® Color Code	PANDUIT® Die Index No.‡	Burdny Die Index No.‡	T&B Die Index No.‡	Wire Strip Length (In.)	Std. Pkg. Qty.
			W	B	T	L						
LCA10-14F-L*	#14 – #10 AWG STR, #12 – #10 AWG SOL	1/4	.42	.38	.05	.94	—	—	—	—	7/16	50
LCA8-10F-L	#8 AWG	#10	.41	.56	.08	.90	Red	P21	49	21	5/8	50
LCA8-14F-L		1/4	.48	.56	.07	.99	Red	P21	49	21	5/8	50
LCA8-56F-L		5/16	.56	.56	.05	1.11	Red	P21	49	21	5/8	50
LCA8-38F-L		3/8	.60	.56	.05	1.21	Red	P21	49	21	5/8	50
LCA6-10F-L	#6 AWG	#10	.45	.81	.09	.94	Blue	P24	7	24	7/8	50
LCA6-14F-L		1/4	.48	.81	.08	1.03	Blue	P24	7	24	7/8	50
LCA6-56F-L		5/16	.56	.81	.07	1.15	Blue	P24	7	24	7/8	50
LCA6-38F-L		3/8	.62	.81	.06	1.25	Blue	P24	7	24	7/8	50
LCA4-10F-L	#4 – #3 AWG STR, #2 AWG SOL	#10	.55	.81	.09	1.03	Gray	P29	8	29	7/8	50
LCA4-14F-L		1/4	.55	.81	.09	1.12	Gray	P29	8	29	7/8	50
LCA4-56F-L		5/16	.55	.81	.09	1.24	Gray	P29	8	29	7/8	50
LCA4-38F-L		3/8	.62	.81	.07	1.34	Gray	P29	8	29	7/8	50
LCA2-14F-Q	#2 AWG	1/4	.60	.88	.10	1.24	Brown	P33	10	33	15/16	25
LCA2-56F-Q		5/16	.66	.88	.10	1.36	Brown	P33	10	33	15/16	25
LCA2-38F-Q		3/8	.66	.88	.10	1.44	Brown	P33	10	33	15/16	25
LCA2-12F-Q		1/2	.75	.88	.08	1.67	Brown	P33	10	33	15/16	25
LCA1-14F-E	#1 AWG	1/4	.70	.88	.11	1.31	Green	P37	11	37	15/16	20
LCA1-56F-E		5/16	.70	.88	.11	1.44	Green	P37	11	37	15/16	20
LCA1-38F-E		3/8	.70	.88	.11	1.51	Green	P37	11	37	15/16	20
LCA1-12F-E		1/2	.75	.88	.09	1.75	Green	P37	11	37	15/16	20
LCA1/0-14F-X	1/0 AWG	1/4	.76	.94	.12	1.45	Pink	P42	12	42	1	10
LCA1/0-56F-X		5/16	.76	.94	.12	1.51	Pink	P42	12	42	1	10
LCA1/0-38F-X		3/8	.76	.94	.12	1.58	Pink	P42	12	42	1	10
LCA1/0-12F-X		1/2	.80	.94	.12	1.82	Pink	P42	12	42	1	10
LCA2/0-14F-X	2/0 AWG	1/4	.85	.98	.13	1.61	Black	P45	13	45	1 1/16	10
LCA2/0-56F-X		5/16	.85	.98	.13	1.59	Black	P45	13	45	1 1/16	10
LCA2/0-38F-X		3/8	.85	.98	.13	1.66	Black	P45	13	45	1 1/16	10
LCA2/0-12F-X		1/2	.85	.98	.13	1.91	Black	P45	13	45	1 1/16	10

PANDUIT® TERMINATION SOLUTIONS



Code Conductor, One-Hole, Standard Barrel with Window Lug, 90° Angle (continued)

Part Number	Copper Conductor Size	Stud Hole Size (In.)	Figure Dimensions (In.)				PANDUIT® Color Code	PANDUIT® Die Index No.‡	Burndy Die Index No.‡	T&B Die Index No.‡	Wire Strip Length (In.)	Std. Pkg. Qty.
			W	B	T	L						
LCA3/0-14F-X	3/0 AWG	1/4	.96	1.14	.13	1.67	Orange	P50	14	50	1 3/16	10
LCA3/0-56F-X		5/16	.96	1.14	.13	1.67	Orange	P50	14	50	1 3/16	10
LCA3/0-38F-X		3/8	.96	1.14	.13	1.73	Orange	P50	14	50	1 3/16	10
LCA3/0-12F-X		1/2	.96	1.14	.13	1.98	Orange	P50	14	50	1 3/16	10
LCA4/0-14F-X	4/0 AWG	1/4	1.06	1.19	.14	1.75	Purple	P54	15	54	1 1/4	10
LCA4/0-56F-X		5/16	1.06	1.19	.14	1.77	Purple	P54	15	54	1 1/4	10
LCA4/0-38F-X		3/8	1.06	1.19	.14	1.84	Purple	P54	15	54	1 1/4	10
LCA4/0-12F-X		1/2	1.06	1.19	.14	2.07	Purple	P54	15	54	1 1/4	10
LCA250-14F-X	250 kcmil	1/4	1.17	1.25	.14	1.82	Yellow	P62	16	62	1 5/16	10
LCA250-56F-X		5/16	1.17	1.25	.14	1.83	Yellow	P62	16	62	1 5/16	10
LCA250-38F-X		3/8	1.17	1.25	.14	1.90	Yellow	P62	16	62	1 5/16	10
LCA250-12F-X		1/2	1.17	1.25	.14	2.13	Yellow	P62	16	62	1 5/16	10
LCA300-56F-X	300 kcmil	5/16	1.19	1.44	.16	2.07	White	P66	17	66	1 1/2	10
LCA300-38F-X		3/8	1.19	1.44	.16	2.07	White	P66	17	66	1 1/2	10
LCA300-12F-X		1/2	1.19	1.44	.16	2.18	White	P66	17	66	1 1/2	10
LCA300-58F-X		5/8	1.19	1.44	.16	2.39	White	P66	17	66	1 1/2	10
LCA300-78F-X	350 kcmil	7/8	1.19	1.44	.16	2.83	White	P66	17	66	1 1/2	10
LCA350-38F-X		3/8	1.28	1.44	.17	2.13	Red	P71	18	71	1 1/2	10
LCA350-12F-X		1/2	1.28	1.44	.17	2.24	Red	P71	18	71	1 1/2	10
LCA350-58F-X		5/8	1.28	1.44	.17	2.45	Red	P71	18	71	1 1/2	10
LCA350-78F-X	400 kcmil	7/8	1.28	1.44	.17	2.89	Red	P71	18	71	1 1/2	10
LCA400-38F-6		3/8	1.39	1.50	.18	2.37	Blue	P76	19	76	1 9/16	6
LCA400-12F-6		1/2	1.39	1.50	.18	2.37	Blue	P76	19	76	1 9/16	6
LCA400-58F-6		5/8	1.39	1.50	.18	2.58	Blue	P76	19	76	1 9/16	6
LCA400-78F-6	500 kcmil	7/8	1.39	1.50	.18	2.97	Blue	P76	19	76	1 9/16	6
LCA500-38F-6		3/8	1.54	1.75	.22	2.32	Brown	P87	20	87	1 13/16	6
LCA500-12F-6		1/2	1.54	1.75	.22	2.48	Brown	P87	20	87	1 13/16	6
LCA500-58F-6		5/8	1.54	1.75	.22	2.69	Brown	P87	20	87	1 13/16	6
LCA500-34F-6	600 kcmil	3/4	1.54	1.75	.22	2.83	Brown	P87	20	87	1 13/16	6
LCA500-78F-6		7/8	1.54	1.75	.22	3.08	Brown	P87	20	87	1 13/16	6
LCA500-1F-6		1	1.54	1.75	.22	3.20	Brown	P87	20	87	1 13/16	6
LCA600-12F-6	600 kcmil	1/2	1.70	1.75	.26	3.21	Green	P94	22	94	1 13/16	6
LCA600-58F-6		5/8	1.70	1.75	.26	3.21	Green	P94	22	94	1 13/16	6
LCA600-78F-6		7/8	1.70	1.75	.26	3.21	Green	P94	22	94	1 13/16	6

‡See [pages L8, L9 and L10, L11](#) in Technical Info section for tool and die information.

*Not tested to NEBS Level 3 requirements.

**Consult cable manufacturer for voltage stress relief instructions with applications greater than 2000 volts.

System Overview

Terminals

Disconnects

Splices

Ferrules

Compression Connectors

Crimping Tools

Mechanical Connectors

Grounding Connectors

Support Products

Technical Info

Index

System Overview



Code Conductor, One-Hole, Standard Barrel with Window, Narrow Tongue Lug

For Use with Stranded Copper Conductors

Terminals

Type LCAN

- Narrow tongue width for limited space applications
- Color coded barrels marked with **PANDUIT®** and specified competitor die index numbers for proper crimp die selection
- Inspection window to visually assure full conductor insertion
- Tin plated to inhibit corrosion
- UL Listed for use up to 35KV**, temperature rated 90°C and CSA Certified to 600V when crimped with **PANDUIT®** and specified competitor crimping tools and dies
- UL Listed and CSA Certified for wire range-taking capability when crimped with **PANDUIT® UNI-DIE™** dieless crimping tools ‡

Disconnects

Splices

Ferrules

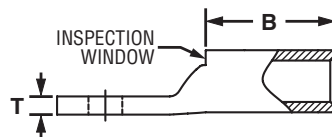
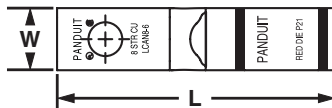

Compression Connectors

Crimping Tools

Mechanical Connectors

Grounding Connectors

Support Products

Technical Info

Index

Part Number	Copper Conductor Size	Stud Hole Size (In.)	Figure Dimensions (In.)				PANDUIT® Color Code	PANDUIT® Die Index No.‡	Burdny Die Index No.‡	T&B Die Index No.‡	Wire Strip Length (In.)	Std. Pkg. Qty.
			W	B	T	L						
LCAN8-6-L	#8 AWG	#6	.27	.56	.08	1.21	Red	P21	49	21	5/8	50
LCAN6-6-L	#6 AWG	#6	.31	.81	.09	1.48	Blue	P24	7	24	7/8	50
LCAN4-10-L	#4 – #3 AWG, #2 AWG SOL	#10	.38	.81	.09	1.54	Gray	P29	8	29	7/8	50
LCAN4-14-L		1/4	.50	.81	.09	1.75	Gray	P29	8	29	7/8	50
LCAN2-10-Q	#2 AWG	#10	.42	.88	.10	1.77	Brown	P33	10	33	15/16	25
LCAN2-14-Q		1/4	.42	.88	.10	1.77	Brown	P33	10	33	15/16	25
LCAN2-56-Q		5/16	.42	.88	.10	1.90	Brown	P33	10	33	15/16	25
LCAN1-10-E	#1 AWG	#10	.47	.88	.11	1.69	Green	P37	11	37	15/16	20
LCAN1-14-E		1/4	.47	.88	.11	1.79	Green	P37	11	37	15/16	20
LCAN1/0-10-X	1/0 AWG	#10	.52	.94	.12	1.78	Pink	P42	12	42	1	10
LCAN1/0-14-X		1/4	.62	.94	.12	2.29	Pink	P42	12	42	1	10
LCAN1/0-56-X		5/16	.52	.94	.12	2.00	Pink	P42	12	42	1	10
LCAN2/0-10-X	2/0 AWG	#10	.58	.98	.13	1.84	Black	P45	13	45	1 1/16	10
LCAN2/0-14-X		1/4	.62	.98	.13	2.55	Black	P45	13	45	1 1/16	10
LCAN2/0-56-X		5/16	.58	.98	.13	2.08	Black	P45	13	45	1 1/16	10
LCAN2/0-38-X		3/8	.58	.98	.13	2.15	Black	P45	13	45	1 1/16	10
LCAN3/0-14-X	3/0 AWG	1/4	.76	1.14	.13	2.74	Orange	P50	14	50	1 3/16	10
LCAN3/0-56-X		5/16	.64	1.14	.13	2.28	Orange	P50	14	50	1 3/16	10
LCAN3/0-38-X		3/8	.64	1.14	.13	2.34	Orange	P50	14	50	1 3/16	10
LCAN4/0-14-X	4/0 AWG	1/4	.76	1.19	.14	2.83	Purple	P54	15	54	1 1/4	10
LCAN4/0-56-X		5/16	.71	1.19	.14	2.38	Purple	P54	15	54	1 1/4	10
LCAN4/0-38-X		3/8	.71	1.19	.14	2.45	Purple	P54	15	54	1 1/4	10



Code Conductor, One-Hole, Standard Barrel with Window, Narrow Tongue Lug (continued)

Part Number	Copper Conductor Size	Stud Hole Size (In.)	Figure Dimensions (In.)				PANDUIT® Color Code	PANDUIT® Die Index No.‡	Burndy Die Index No.‡	T&B Die Index No.‡	Wire Strip Length (In.)	Std. Pkg. Qty.
			W	B	T	L						
LCAN250-14-X	250 kcmil	1/4	.96	1.25	.14	2.99	Yellow	P62	16	62	1 5/16	10
LCAN250-38-X		3/8	.77	1.25	.14	2.55	Yellow	P62	16	62	1 5/16	10
LCAN300-14-X	300 kcmil	1/4	.96	1.44	.16	3.33	White	P66	17	66	1 1/2	10
LCAN300-38-X		3/8	.81	1.44	.16	2.94	White	P66	17	66	1 1/2	10
LCAN350-38-X	350 kcmil	3/8	.88	1.44	.17	2.98	Red	P71	18	71	1 1/2	10
LCAN350-12-X		1/2	1.09	1.44	.17	3.62	Red	P71	18	71	1 1/2	10
LCAN400-38-6	400 kcmil	3/8	.95	1.50	.18	3.06	Blue	P76	19	76	1 9/16	6
LCAN400-12-6		1/2	.95	1.50	.18	3.22	Blue	P76	19	76	1 9/16	6
LCAN500-38-6	500 kcmil	3/8	1.06	1.75	.22	3.39	Brown	P87	20	87	1 13/16	6
LCAN500-12-6		1/2	1.06	1.75	.22	3.55	Brown	P87	20	87	1 13/16	6
LCAN600-38-6	600 kcmil	3/8	1.12	1.75	.26	3.44	Green	P94	22	94	1 13/16	6
LCAN600-12-6		1/2	1.19	1.75	.26	4.20	Green	P94	22	94	1 13/16	6
LCAN750-38-6	750 kcmil	3/8	1.30	1.88	.26	3.84	Black	P106	24	106	1 5/8	6
LCAN750-12-6		1/2	1.30	1.88	.26	4.03	Black	P106	24	106	1 15/16	6
LCAN750-58-6		5/8	1.49	1.63	.28	4.52	Black	P106	24	106	1 5/8	6

‡See [pages L8, L9 and L10, L11](#) in Technical Info section for tool and die information.

**Consult cable manufacturer for voltage stress relief instructions with applications greater than 2000 volts.

System Overview

Terminals

Disconnects

Splices

Ferrules

Compression Connectors

Crimping Tools

Mechanical Connectors

Grounding Connectors

Support Products

Technical Info

Index

PANDUIT® TERMINATION SOLUTIONS

System Overview



Code Conductor, Short Blank Tongue, Standard Barrel with Window Lug

For Use with Stranded Copper Conductors

Type LCA-00

- Color coded barrels marked with **PANDUIT®** and specified competitor die index numbers for proper crimp die selection
- Inspection window to visually assure full conductor insertion
- Tin plated to inhibit corrosion
- UL Recognized for use up to 35KV**, temperature rated 90°C and CSA Certified to 600V when crimped with **PANDUIT®** and specified competitor crimping tools and dies

Disconnects

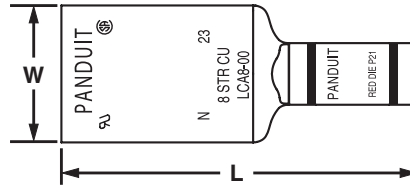

Splices

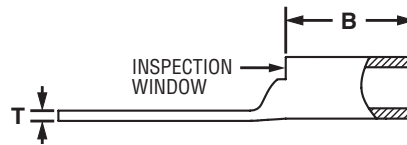

Ferrules

Part Number	Copper Conductor Size	Figure Dimensions (In.)				PANDUIT® Color Code	PANDUIT® Die Index No.‡	Burndy Die Index No.‡	T&B Die Index No.‡	Wire Strip Length (In.)	Std. Pkg. Qty.
		W	B	T	L						
LCA8-00-L	#8 AWG	.60	.56	.05	1.56	Red	P21	49	21	5/8	50
LCA6-00-L	#6 AWG	.62	.81	.06	1.83	Blue	P24	7	24	7/8	50
LCA4-00-L	#4 AWG	.62	.81	.07	1.85	Gray	P29	8	29	7/8	50
LCA2-00-Q	#2 AWG	.75	.88	.08	2.21	Brown	P33	10	33	15/16	25
LCA1-00-E	#1 AWG	.75	.88	.09	2.23	Green	P37	11	37	15/16	20
LCA1/0-00-X	1/0 AWG	.80	.94	.12	2.31	Pink	P42	12	42	1	10
LCA2/0-00-X	2/0 AWG	.85	.98	.13	2.40	Black	P45	13	45	1 1/16	10
LCA3/0-00-X	3/0 AWG	.96	1.14	.13	2.59	Orange	P50	14	50	1 3/16	10
LCA4/0-00-X	4/0 AWG	1.06	1.19	.14	2.68	Purple	P54	15	54	1 1/4	10
LCA300-00-X	300 kcmil	1.19	1.44	.16	3.70	White	P66	17	66	1 1/2	10
LCA350-00-X	350 kcmil	1.28	1.44	.17	3.74	Red	P71	18	71	1 1/2	10
LCA400-00-6	400 kcmil	1.39	1.50	.18	3.82	Blue	P76	19	76	1 9/16	6
LCA500-00-6	500 kcmil	1.54	1.75	.22	4.27	Brown	P87	20	87	1 13/16	6
LCA600-00-6	600 kcmil	1.70	1.75	.26	4.20	Green	P94	22	94	1 13/16	6

‡See pages **L8, L9 and L10, L11** in Technical Info section for tool and die information.

**Consult cable manufacturer for voltage stress relief instructions with applications greater than 2000 volts.

Grounding Connectors

Support Products

Technical Info

Index



Code Conductor, One-Hole, Long Barrel Lug

For Use with Stranded Copper Conductors

Type LCB

- Long barrel maximizes number of crimps and provides premium wire pull-out strength and electrical performance
- Color coded barrels marked with **PANDUIT®** and specified competitor die index numbers for proper crimp die selection
- Enclosed barrel prevents corrosive material from entering barrel when used in harsh environments
- Tin plated to inhibit corrosion
- UL Listed for use up to 35KV**, temperature rated 90°C and CSA Certified to 600V when crimped with **PANDUIT®** and specified competitor crimping tools and dies
- UL Listed and CSA Certified for wire range-taking capability when crimped with **PANDUIT® UNI-DIE™** dieless crimping tools‡
- Tested by Telcordia — meets **NEBS Level 3**

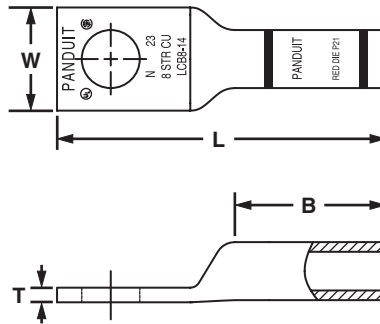

Part Number	Copper Conductor Size	Stud Hole Size (In.)	Figure Dimensions (In.)				PANDUIT® Color Code	PANDUIT® Die Index No.‡	Burndy Die Index No.‡	T&B Die Index No.‡	Wire Strip Length (In.)	Std. Pkg. Qty.
			W	B	T	L						
LCB8-10-L	#8 AWG	#10	.41	.70	.08	1.44	Red	P21	49	21	3/4	50
LCB8-14-L		1/4	.48	.70	.07	1.53	Red	P21	49	21	3/4	50
LCB8-38-L		3/8	.60	.70	.05	1.75	Red	P21	49	21	3/4	50
LCB6-10-L	#6 AWG	#10	.45	1.07	.09	1.84	Blue	P24	7	24	1 1/4	50
LCB6-14-L		1/4	.48	1.07	.08	1.93	Blue	P24	7	24	1 1/4	50
LCB6-38-L		3/8	.62	1.07	.05	2.15	Blue	P24	7	24	1 1/4	50
LCB4-10-L	#4 – #3 AWG STR, #2 AWG SOL	#10	.55	1.05	.09	1.86	Gray	P29	8	29	1 1/8	50
LCB4-14-L		1/4	.55	1.05	.09	1.95	Gray	P29	8	29	1 1/8	50
LCB4-38-L		3/8	.62	1.05	.07	2.17	Gray	P29	8	29	1 1/8	50
LCB2-10-Q	#2 AWG	#10	.60	1.16	.10	2.07	Brown	P33	10	33	1 1/4	25
LCB2-56-Q		5/16	.66	1.16	.10	2.27	Brown	P33	10	33	1 1/4	25
LCB2-38-Q		3/8	.66	1.16	.10	2.34	Brown	P33	10	33	1 1/4	25
LCB1-10-E	#1 AWG	#10	.70	1.36	.11	2.30	Green	P37	11	37	1 7/16	20
LCB1-56-E		5/16	.70	1.36	.11	2.50	Green	P37	11	37	1 7/16	20
LCB1-38-E		3/8	.70	1.36	.11	2.57	Green	P37	11	37	1 7/16	20
LCB1/0-10-X	1/0 AWG	#10	.76	1.44	.12	2.41	Pink	P42	12	42	1 1/2	10
LCB1/0-56-X		5/16	.76	1.44	.12	2.61	Pink	P42	12	42	1 1/2	10
LCB1/0-38-X		3/8	.76	1.44	.12	2.69	Pink	P42	12	42	1 1/2	10
LCB1/0-12-X		1/2	.80	1.44	.12	2.92	Pink	P42	12	42	1 1/2	10

Chart continues on page F22

System Overview



Code Conductor, One-Hole, Long Barrel Lug (continued)

Terminals

Disconnects

Splices

Ferrules

Compression Connectors

Crimping Tools

Mechanical Connectors

Grounding Connectors

Support Products

Technical Info

Index

Part Number	Copper Conductor Size	Stud Hole Size (In.)	Figure Dimensions (In.)				PANDUIT® Color Code	PANDUIT® Die Index No.‡	Burndy Die Index No.‡	T&B Die Index No.‡	Wire Strip Length (In.)	Std. Pkg. Qty.
			W	B	T	L						
LCB2/0-38-X	2/0 AWG	3/8	.85	1.50	.13	2.82	Black	P45	13	45	1 5/8	10
LCB2/0-12-X		1/2	.85	1.50	.13	3.07	Black	P45	13	45	1 5/8	10
LCB3/0-38-X	3/0 AWG	3/8	.96	1.50	.13	2.87	Orange	P50	14	50	1 9/16	10
LCB3/0-12-X		1/2	.96	1.50	.13	3.12	Orange	P50	14	50	1 9/16	10
LCB4/0-38-X	4/0 AWG	3/8	1.06	1.56	.14	3.03	Purple	P54	15	54	1 5/8	10
LCB4/0-12-X		1/2	1.06	1.56	.14	3.22	Purple	P54	15	54	1 5/8	10
LCB250-12-X	250 kcmil	1/2	1.17	1.61	.14	3.32	Yellow	P62	16	62	1 11/16	10
LCB250-78-X		7/8	1.25	1.61	.12	3.85	Yellow	P62	16	62	1 11/16	10
LCB300-56-X	300 kcmil	5/16	1.19	2.24	.16	3.95	White	P66	17	66	2 5/16	10
LCB300-38-X		3/8	1.19	2.24	.16	3.95	White	P66	17	66	2 5/16	10
LCB300-12-X		1/2	1.19	2.24	.16	4.06	White	P66	17	66	2 5/16	10
LCB350-12-X	350 kcmil	1/2	1.28	2.24	.17	4.11	Red	P71	18	71	2 5/16	10
LCB350-78-X		7/8	1.28	2.24	.17	4.78	Red	P71	18	71	2 5/16	10
LCB400-38-6	400 kcmil	3/8	1.39	2.30	.18	4.27	Blue	P76	19	76	2 3/8	6
LCB400-12-6		1/2	1.39	2.30	.18	4.27	Blue	P76	19	76	2 3/8	6
LCB400-58-6		5/8	1.39	2.30	.18	4.48	Blue	P76	19	76	2 3/8	6
LCB400-78-6		7/8	1.39	2.30	.18	4.88	Blue	P76	19	76	2 3/8	6
LCB500-12-6	500 kcmil	1/2	1.54	2.50	.22	4.53	Brown	P87	20	87	2 5/8	6
LCB500-58-6		5/8	1.54	2.50	.22	4.74	Brown	P87	20	87	2 5/8	6
LCB500-78-6		7/8	1.54	2.50	.22	5.13	Brown	P87	20	87	2 5/8	6
LCB600-12-6	600 kcmil	1/2	1.70	2.69	.26	5.40	Green	P94	22	94	2 3/4	6
LCB600-58-6		5/8	1.70	2.69	.26	5.40	Green	P94	22	94	2 3/4	6
LCB750-58-6	750 kcmil	5/8	1.89	2.88	.26	5.98	Black	P106	24	106	2 15/16	6
LCB750-78-6		7/8	1.89	2.88	.26	6.07	Black	P106	24	106	2 15/16	6
LCB800-58-6	800 kcmil	5/8	1.95	2.94	.29	6.06	Orange	P107	25	107	3	6
LCB1000-58-3	1000 kcmil	5/8	2.17	3.00	.32	6.32	White	P125	27	125	3 1/16	3

‡See [pages L12, L13 and L14, L15](#) in Technical Info section for tool and die information.
 **Consult cable manufacturer for voltage stress relief instructions with applications greater than 2000 volts.



Code Conductor, One-Hole, Long Barrel Lug, 45° Angle

For Use with Stranded Copper Conductors

Type LCB-H

- Long barrel maximizes number of crimps and provides premium wire pull-out strength and electrical performance
- Color coded barrels marked with **PANDUIT®** and specified competitor die index numbers for proper crimp die selection
- Enclosed barrel prevents corrosive material from entering barrel when used in harsh environments
- Tin plated to inhibit corrosion

- UL Listed for use up to 35KV**, temperature rated 90°C and CSA Certified to 600V when crimped with **PANDUIT®** and specified competitor crimping tools and dies
- UL Listed and CSA Certified for wire range-taking capability when crimped with **PANDUIT® UNI-DIE™** dieless crimping tools‡
- **Tested by Telcordia — meets NEBS Level 3**

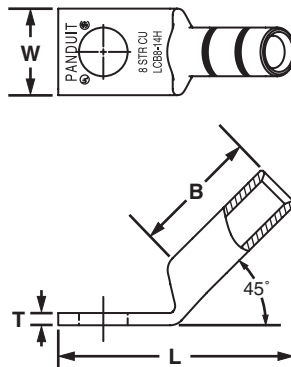

Part Number	Copper Conductor Size	Stud Hole Size (In.)	Figure Dimensions (In.)				PANDUIT® Color Code	PANDUIT® Die Index No.‡	Burndy Die Index No.‡	T&B Die Index No.‡	Wire Strip Length (In.)	Std. Pkg. Qty.
			W	B	T	L						
LCB8-10H-L	#8 AWG	#10	.41	.70	.08	1.23	Red	P21	49	21	3/4	50
LCB8-14H-L		1/4	.48	.70	.07	1.31	Red	P21	49	21	3/4	50
LCB6-10H-L	#6 AWG	#10	.45	1.07	.09	1.52	Blue	P24	7	24	1 1/8	50
LCB6-14H-L		1/4	.48	1.07	.08	1.60	Blue	P24	7	24	1 1/8	50
LCB6-38H-L		3/8	.62	1.07	.05	1.81	Blue	P24	7	24	1 1/8	50
LCB4-10H-L	#4 – #3 AWG STR, #2 AWG SOL	#10	.55	1.05	.09	1.54	Gray	P29	8	29	1 1/8	50
LCB4-14H-L		1/4	.55	1.05	.09	1.63	Gray	P29	8	29	1 1/8	50
LCB2-10H-Q	#2 AWG	#10	.60	1.16	.10	1.68	Brown	P33	10	33	1 1/4	25
LCB2-56H-Q		5/16	.66	1.16	.10	1.87	Brown	P33	10	33	1 1/4	25
LCB1-10H-E	#1 AWG	#10	.70	1.36	.11	1.83	Green	P37	11	37	1 7/16	20
LCB1-56H-E		5/16	.70	1.36	.11	2.03	Green	P37	11	37	1 7/16	20
LCB1/0-10H-X	1/0 AWG	#10	.76	1.44	.12	1.92	Pink	P42	12	42	1 1/2	10
LCB1/0-56H-X		5/16	.76	1.44	.12	2.12	Pink	P42	12	42	1 1/2	10
LCB1/0-38H-X		3/8	.76	1.44	.12	2.19	Pink	P42	12	42	1 1/2	10
LCB1/0-12H-X		1/2	.80	1.44	.11	2.42	Pink	P42	12	42	1 1/2	10
LCB2/0-38H-X	2/0 AWG	3/8	.85	1.50	.13	2.31	Black	P45	13	45	1 9/16	10
LCB2/0-12H-X		1/2	.85	1.50	.13	2.53	Black	P45	13	45	1 9/16	10
LCB3/0-38H-X	3/0 AWG	3/8	.96	1.50	.13	2.33	Orange	P50	14	50	1 9/16	10
LCB3/0-12H-X		1/2	.96	1.50	.13	2.58	Orange	P50	14	50	1 9/16	10
LCB4/0-38H-X	4/0 AWG	3/8	1.06	1.56	.14	2.48	Purple	P54	15	54	1 5/8	10
LCB4/0-12H-X		1/2	1.06	1.56	.14	2.67	Purple	P54	15	54	1 5/8	10
LCB250-12H-X	250 kcmil	1/2	1.17	1.61	.14	2.74	Yellow	P62	16	62	1 11/16	10
LCB250-78H-X		7/8	1.17	1.61	.14	3.27	Yellow	P62	16	62	1 11/16	10
LCB300-56H-X	300 kcmil	5/16	1.19	2.24	.16	3.24	White	P66	17	66	2 5/16	10
LCB300-38H-X		3/8	1.19	2.24	.16	3.24	White	P66	17	66	2 5/16	10
LCB300-12H-X		1/2	1.19	2.24	.16	3.35	White	P66	17	66	2 5/16	10
LCB350-12H-X	350 kcmil	1/2	1.28	2.24	.17	3.39	Red	P71	18	71	2 5/16	10
LCB350-78H-X		7/8	1.28	2.24	.17	4.04	Red	P71	18	71	2 5/16	10

Chart continues on page F24

System Overview



Code Conductor, One-Hole, Long Barrel Lug, 45° Angle (continued)

Terminals

Disconnects

Splices

Ferrules

Compression Connectors

Crimping Tools

Mechanical Connectors

Grounding Connectors

Support Products

Technical Info

Index

Part Number	Copper Conductor Size	Stud Hole Size (In.)	Figure Dimensions (In.)				PANDUIT® Color Code	PANDUIT® Die Index No.‡	Burndy Die Index No.‡	T&B Die Index No.‡	Wire Strip Length (In.)	Std. Pkg. Qty.
			W	B	T	L						
LCB400-12H-6	400 kcmil	1/2	1.39	2.30	.18	3.53	Blue	P76	19	76	2 3/8	6
LCB400-58H-6		5/8	1.39	2.30	.18	3.74	Blue	P76	19	76	2 3/8	6
LCB400-78H-6		7/8	1.39	2.30	.18	4.13	Blue	P76	19	76	2 3/8	6
LCB500-12H-6	500 kcmil	1/2	1.54	2.50	.22	3.74	Brown	P87	20	87	2 9/16	6
LCB500-58H-6		5/8	1.54	2.50	.22	3.95	Brown	P87	20	87	2 9/16	6
LCB500-78H-6		7/8	1.54	2.50	.22	4.34	Brown	P87	20	87	2 9/16	6
LCB600-12H-6	600 kcmil	1/2	1.70	2.69	.26	4.56	Green	P94	22	94	2 3/4	6
LCB600-58H-6		5/8	1.70	2.69	.26	4.56	Green	P94	22	94	2 3/4	6

‡See [pages L12, L13 and L14, L15](#) in Technical Info section for tool and die information.

**Consult cable manufacturer for voltage stress relief instructions with applications greater than 2000 volts.



Code Conductor, One-Hole, Long Barrel Lug, 90° Angle

For Use with Stranded Copper Conductors

Type LCB-F

- Long barrel maximizes number of crimps and provides premium wire pull-out strength and electrical performance
- Color coded barrels marked with *PANDUIT®* and specified competitor die index numbers for proper crimp die selection
- Enclosed barrel prevents corrosive material from entering barrel when used in harsh environments
- Tin plated to inhibit corrosion

- UL Listed for use up to 35KV**, temperature rated 90°C and CSA Certified to 600V when crimped with *PANDUIT®* and specified competitor crimping tools and dies
- UL Listed and CSA Certified for wire range-taking capability when crimped with *PANDUIT® UNI-DIE™* dieless crimping tools‡
- Tested by Telcordia — meets NEBS Level 3

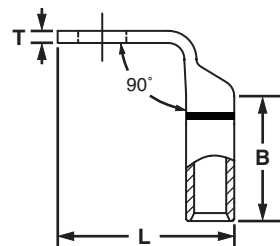

Part Number	Copper Conductor Size	Stud Hole Size (In.)	Figure Dimensions (In.)				PANDUIT® Color Code	PANDUIT® Die Index No.‡	Burndy Die Index No.‡	T&B Die Index No.‡	Wire Strip Length (In.)	Std. Pkg. Qty.
			W	B	T	L						
LCB8-10F-L	#8 AWG	#10	.41	.70	.08	1.08	Red	P21	49	21	3/4	50
LCB8-14F-L		1/4	.48	.70	.07	1.07	Red	P21	49	21	3/4	50
LCB6-10F-L	#6 AWG	#10	.45	1.07	.09	1.49	Blue	P24	7	24	1 1/4	50
LCB6-14F-L		1/4	.48	1.07	.08	1.48	Blue	P24	7	24	1 1/4	50
LCB6-38F-L		3/8	.62	1.07	.05	1.45	Blue	P24	7	24	1 1/4	50
LCB4-10F-L	#4 – #3 AWG STR, #2 AWG SOL	#10	.55	1.05	.09	1.53	Gray	P29	8	29	1 1/8	50
LCB4-14F-L		1/4	.55	1.05	.09	1.53	Gray	P29	8	29	1 1/8	50
LCB2-10F-Q	#2 AWG	#10	.60	1.16	.10	1.75	Brown	P33	10	33	1 1/4	25
LCB2-56F-Q		5/16	.66	1.16	.10	1.74	Brown	P33	10	33	1 1/4	25
LCB1-10F-E	#1 AWG	#10	.70	1.36	.11	2.00	Green	P37	11	37	1 7/16	20
LCB1-56F-E		5/16	.70	1.36	.11	2.00	Green	P37	11	37	1 7/16	20
LCB1/0-10F-X	1/0 AWG	#10	.76	1.44	.12	2.15	Pink	P42	12	42	1 1/2	10
LCB1/0-56F-X		5/16	.76	1.44	.12	2.15	Pink	P42	12	42	1 1/2	10
LCB1/0-38F-X		3/8	.76	1.44	.12	2.15	Pink	P42	12	42	1 1/2	10
LCB1/0-12F-X		1/2	.80	1.44	.12	2.14	Pink	P42	12	42	1 1/2	10
LCB2/0-38F-X	2/0 AWG	3/8	.85	1.50	.13	2.30	Black	P45	13	45	1 9/16	10
LCB2/0-12F-X		1/2	.85	1.50	.13	2.30	Black	P45	13	45	1 9/16	10
LCB3/0-38F-X	3/0 AWG	3/8	.96	1.50	.13	2.35	Orange	P50	14	50	1 9/16	10
LCB3/0-12F-X		1/2	.96	1.50	.13	2.35	Orange	P50	14	50	1 9/16	10
LCB4/0-38F-X	4/0 AWG	3/8	1.06	1.56	.14	2.48	Purple	P54	15	54	1 5/8	10
LCB4/0-12F-X		1/2	1.06	1.56	.14	2.48	Purple	P54	15	54	1 5/8	10

Chart continues on page F26

System Overview



Code Conductor, One-Hole, Long Barrel Lug, 90° Angle (continued)

Terminals

Disconnects

Splices

Ferrules

Part Number	Copper Conductor Size	Stud Hole Size (In.)	Figure Dimensions (In.)				PANDUIT® Color Code	PANDUIT® Die Index No.‡	Burndy Die Index No.‡	T&B Die Index No.‡	Wire Strip Length (In.)	Std. Pkg. Qty.
			W	B	T	L						
LCB250-12F-X	250 kcmil	1/2	1.17	1.61	.14	2.57	Yellow	P62	16	62	1 3/4	10
LCB250-78F-X		7/8	1.25	1.61	.12	2.49	Yellow	P62	16	62	1 3/4	10
LCB300-56F-X		5/16	1.19	2.24	.16	3.29	White	P66	17	66	2 5/16	10
LCB300-38F-X	300 kcmil	3/8	1.19	2.24	.16	3.29	White	P66	17	66	2 5/16	10
LCB300-12F-X		1/2	1.19	2.24	.16	3.29	White	P66	17	66	2 5/16	10
LCB350-12F-X	350 kcmil	1/2	1.28	2.24	.17	3.34	Red	P71	18	71	2 5/16	10
LCB350-78F-X		7/8	1.28	2.24	.17	3.34	Red	P71	18	71	2 5/16	10
LCB400-12F-6	400 kcmil	1/2	1.39	2.30	.18	3.47	Blue	P76	19	76	2 3/8	6
LCB400-58F-6		5/8	1.39	2.30	.18	3.47	Blue	P76	19	76	2 3/8	6
LCB400-78F-6		7/8	1.39	2.30	.18	3.47	Blue	P76	19	76	2 3/8	6
LCB500-12F-6	500 kcmil	1/2	1.54	2.50	.22	3.77	Brown	P87	20	87	2 5/8	6
LCB500-58F-6		5/8	1.54	2.50	.22	3.77	Brown	P87	20	87	2 5/8	6
LCB500-78F-6		7/8	1.54	2.50	.22	3.77	Brown	P87	20	87	2 5/8	6
LCB600-12F-6	600 kcmil	1/2	1.70	2.69	.26	4.08	Green	P94	22	94	2 3/4	6
LCB600-58F-6		5/8	1.70	2.69	.26	4.08	Green	P94	22	94	2 3/4	6

‡See [pages L12, L13 and L14, L15](#) in Technical Info section for tool and die information.

**Consult cable manufacturer for voltage stress relief instructions with applications greater than 2000 volts.

Compression Connectors

Crimping Tools

Mechanical Connectors

Grounding Connectors

Support Products

Technical Info

Index

NEW!



Code Conductor, One-Hole, Long Barrel with Window Lug

For Use with Stranded Copper Conductors

Type LCB-W

- Long barrel maximizes number of crimps and provides premium wire pull-out strength and electrical performance
- Inspection window to visually assure full conductor insertion
- Color coded barrels marked with **PANDUIT®** and specified competitor die index numbers for proper crimp die selection
- Tin plated to inhibit corrosion
- UL Listed for use up to 35KV**, temperature rated 90°C and CSA Certified to 600V when crimped with **PANDUIT®** and specified competitor crimping tools and dies
- UL Listed and CSA Certified for wire range-taking capability when crimped with **PANDUIT® UNI-DIE™** dieless crimping tools‡
- **Tested by Telcordia — meets NEBS Level 3**
- Meets TIA-607 requirements for network systems grounding applications

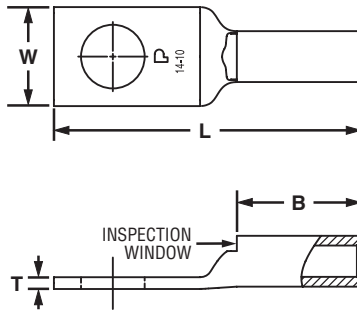

Part Number	Copper Conductor Size	Stud Hole Size (In.)	Figure Dimensions (In.)				PANDUIT® Color Code	PANDUIT® Die Index No.‡	Burndy Die Index No.‡	T&B Die Index No.‡	Wire Strip Length (In.)	Std. Pkg. Qty.
			W	B	T	L						
LCB10-14W-L*	#14 – #10 AWG STR #12 – #10 AWG SOL	1/4	.42	.53	.05	1.31	—	—	—	—	9/16	50
LCB750-38W-6	750 kcmil	3/8	1.89	2.88	.26	4.83	Black	P106	24	106	2 15/16	6
LCB750-12W-6		1/2	1.89	2.88	.26	5.03	Black	P106	24	106	2 15/16	6
LCB750-58W-6		5/8	1.89	2.88	.26	5.58	Black	P106	24	106	2 15/16	6
LCB750-78W-6		7/8	1.89	2.88	.26	5.68	Black	P106	24	106	2 15/16	6
LCB800-12W-6	800 kcmil	1/2	1.95	2.94	.30	5.11	Orange	P107	25	107	3	6
LCB800-58W-6		5/8	1.95	2.94	.30	5.68	Orange	P107	25	107	3	6
LCB1000-38W-3	1000 kcmil	3/8	2.17	3.00	.32	5.08	White	P125	27	125	3 1/16	3
LCB1000-12W-3		1/2	2.17	3.00	.32	5.27	White	P125	27	125	3 1/16	3
LCB1000-58W-3		5/8	2.17	3.00	.32	5.92	White	P125	27	125	3 1/16	3

‡See [pages L12, L13 and L14, L15](#) in Technical Info section for tool and die information.

*Not tested to NEBS Level 3 requirements.

**Consult cable manufacturer for voltage stress relief instructions with applications greater than 2000 volts.

System Overview

Terminals

Disconnects

Splices

Ferrules

Compression Connectors

Crimping Tools

Mechanical Connectors

Grounding Connectors

Support Products

Technical Info

Index

System Overview

NEW!



Code Conductor, One-Hole, Long Barrel with Window Lug, 45° Angle

Terminals

For Use with Stranded Copper Conductors Type LCB-WH

- Long barrel maximizes number of crimps and provides premium wire pull-out strength and electrical performance
- Inspection window to visually assure full conductor insertion
- Tin plated to inhibit corrosion
- UL Listed for use up to 35KV**, temperature rated 90°C and CSA Certified to 600V when crimped with *PANDUIT®* tools and dies
- Meets TIA-607 requirements for network systems grounding applications

Disconnects

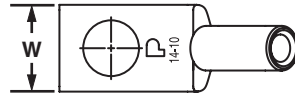

Splices

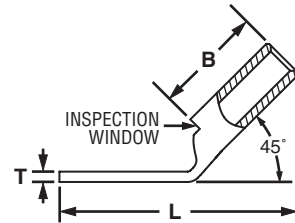

Ferrules

Compression Connectors

Part Number	Copper Conductor Size	Stud Hole Size (In.)	Figure Dimensions (In.)				PANDUIT® Color Code	PANDUIT® Die Index No.‡	Burndy Die Index No.‡	T&B Die Index No.‡	Wire Strip Length (In.)	Std. Pkg. Qty.
			W	B	T	L						
LCB10-14WH-L	#14 – #10 AWG STR #12 – #10 AWG SOL	1/4	.42	.53	.05	1.15	—	—	—	—	9/16	50

‡See [pages L12, L13 and L14, L15](#) in Technical Info section for tool and die information.

**Consult cable manufacturer for voltage stress relief instructions with applications greater than 2000 volts.

Crimping Tools

Mechanical Connectors

Grounding Connectors

Support Products

Technical Info

Index

NEW!



Code Conductor, One-Hole, Long Barrel with Window Lug, 90° Angle

For Use with Stranded Copper Conductors

Type LCB-WF

- Long barrel maximizes number of crimps and provides premium wire pull-out strength and electrical performance
- Inspection window to visually assure full conductor insertion
- Tin plated to inhibit corrosion
- UL Listed for use up to 35KV**, temperature rated 90°C and CSA Certified to 600V when crimped with *PANDUIT®* tools and dies
- Meets TIA-607 requirements for network systems grounding applications

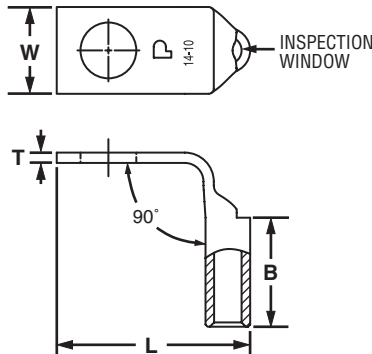

Part Number	Copper Conductor Size	Stud Hole Size (In.)	Figure Dimensions (In.)				PANDUIT® Color Code	PANDUIT® Die Index No.‡	Burdny Die Index No.‡	T&B Die Index No.‡	Wire Strip Length (In.)	Std. Pkg. Qty.
			W	B	T	L						
LCB10-14WF-L	#14 – #10 AWG STR #12 – #10 AWG SOL	1/4	.42	.53	.05	.94	—	—	—	—	9/16	50

‡See [pages L12, L13 and L14, L15](#) in Technical Info section for tool and die information.

**Consult cable manufacturer for voltage stress relief instructions with applications greater than 2000 volts.

System Overview

Terminals

Disconnects

Splices

Ferrules

Compression Connectors

Crimping Tools

Mechanical Connectors

Grounding Connectors

Support Products

Technical Info

Index

System Overview



Code Conductor, One-Hole, Long Barrel with Corona Relief Taper Lug

To Facilitate Use with Stranded Copper Conductors in Applications of 5000V or More

Type LCBH

Terminals

- Externally chamfered barrel end inhibits Corona effect when used in high voltage applications
- Long barrel maximizes number of crimps and provides premium wire pull-out strength and electrical performance
- Color coded barrels marked with **PANDUIT®** and specified competitor die index numbers for proper crimp die selection
- Enclosed barrel prevents corrosive material from entering barrel when used in harsh environments
- Tin plated to inhibit corrosion
- UL Listed for use up to 35KV**, temperature rated 90°C and CSA Certified to 600V when crimped with **PANDUIT®** and specified competitor crimping tools and dies

Disconnects

Splices

Ferrules

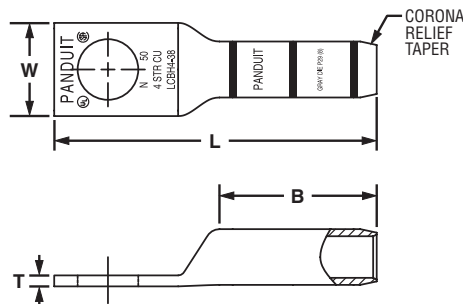

Compression Connectors

Crimping Tools

Mechanical Connectors

Grounding Connectors

Support Products

Technical Info

Index

Part Number	Copper Conductor Size	Stud Hole Size (In.)	Figure Dimensions (In.)				PANDUIT® Color Code	PANDUIT® Die Index No.‡	Burdny Die Index No.‡	T&B Die Index No.‡	Wire Strip Length (In.)	Std. Pkg. Qty.
			W	B	T	L						
LCBH4-38-L	#4 AWG	3/8	.62	1.05	.07	2.16	Gray	P29	8	29	1 1/8	50
LCBH2-38-Q	#2 AWG	3/8	.66	1.16	.10	2.34	Brown	P33	10	33	1 1/4	25
LCBH1-38-E	#1 AWG	3/8	.70	1.36	.10	2.57	Green	P37	11	37	1 7/16	20
LCBH1/0-38-X	1/0 AWG	3/8	.76	1.44	.12	2.69	Pink	P42	12	42	1 1/2	10
LCBH2/0-12-X	2/0 AWG	1/2	.85	1.50	.13	3.07	Black	P45	13	45	1 5/8	10
LCBH3/0-12-X	3/0 AWG	1/2	.96	1.50	.13	3.12	Orange	P50	14	50	1 5/8	10
LCBH4/0-12-X	4/0 AWG	1/2	1.06	1.56	.14	3.22	Purple	P54	15	54	1 5/8	10
LCBH250-12-X	250 kcmil	1/2	1.17	1.61	.14	3.32	Yellow	P62	16	62	1 11/16	10

‡See [pages L16, L17](#) in Technical Info section for tool and die information.

**Consult cable manufacturer for voltage stress relief instructions with applications greater than 2000 volts.



Code Conductor, Two-Hole, Standard Barrel with Window Lug

For Use with Stranded Copper Conductors

Type LCD

- Color coded barrels marked with **PANDUIT®** and specified competitor die index numbers for proper crimp die selection
- Inspection window to visually assure full conductor insertion
- Tin plated to inhibit corrosion
- UL Listed for use up to 35KV**, temperature rated 90°C and CSA Certified to 600V when crimped with **PANDUIT®** and specified competitor crimping tools and dies
- UL Listed and CSA Certified for wire range-taking capability when crimped with **PANDUIT® UNI-DIE™** dieless crimping tools‡
- **Tested by Telcordia — meets NEBS Level 3**
- Available with NEMA hole sizes and spacing

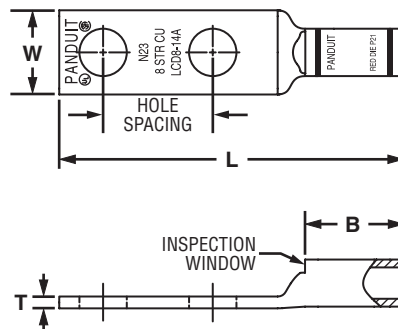

Part Number	Copper Conductor Size	Stud Hole Size (In.)	Stud Hole Spacing (In.)	Figure Dimensions (In.)				PANDUIT® Color Code	PANDUIT® Die Index No.‡	Burndy Die Index No.‡	T&B Die Index No.‡	Wire Strip Length (In.)	Std. Pkg. Qty.
				W	B	T	L						
LCD10-10A-L*	#14 - #10 AWG STR #12 - #10 AWG SOL	#10	.63	.38	.38	.06	1.69	—	—	—	—	7/16	50
LCD10-14A-L*		1/4	.63	.42	.38	.05	1.78	—	—	—	—	7/16	50
LCD10-14B-L*		1/4	.75	.42	.38	.05	1.91	—	—	—	—	7/16	50
LCD10-14D-L*		1/4	1.00	.42	.38	.05	2.16	—	—	—	—	7/16	50
LCD10-38D-L*		3/8	1.00	.56	.38	.04	2.38	—	—	—	—	7/16	50
LCD8-10A-L	#8 AWG	#10	.63	.41	.56	.08	1.88	Red	P21	49	21	5/8	50
LCD8-14A-L		1/4	.63	.48	.56	.07	1.97	Red	P21	49	21	5/8	50
LCD8-14B-L		1/4	.75	.48	.56	.07	2.09	Red	P21	49	21	5/8	50
LCD8-14D-L		1/4	1.00	.48	.56	.07	2.34	Red	P21	49	21	5/8	50
LCD8-38D-L		3/8	1.00	.60	.56	.05	2.56	Red	P21	49	21	5/8	50
LCD6-10A-L	#6 AWG	#10	.63	.46	.81	.08	2.15	Blue	P24	7	24	7/8	50
LCD6-10B-L		#10	.75	.46	.81	.08	2.27	Blue	P24	7	24	7/8	50
LCD6-10D-L		#10	1.00	.46	.81	.08	2.52	Blue	P24	7	24	7/8	50
LCD6-14A-L		1/4	.63	.48	.81	.08	2.24	Blue	P24	7	24	7/8	50
LCD6-14B-L		1/4	.75	.48	.81	.08	2.36	Blue	P24	7	24	7/8	50
LCD6-14D-L		1/4	1.00	.48	.81	.08	2.61	Blue	P24	7	24	7/8	50
LCD6-56D-L		5/16	1.00	.56	.81	.07	2.73	Blue	P24	7	24	7/8	50
LCD6-38D-L	3/8	1.00	.62	.81	.06	2.83	Blue	P24	7	24	7/8	50	
LCD4-10A-L	#4 - #3 AWG STR, #2 AWG SOL	#10	.63	.55	.81	.09	2.17	Gray	P29	8	29	7/8	50
LCD4-10B-L		#10	.75	.55	.81	.09	2.29	Gray	P29	8	29	7/8	50
LCD4-14A-L		1/4	.63	.55	.81	.09	2.26	Gray	P29	8	29	7/8	50
LCD4-14B-L		1/4	.75	.55	.81	.09	2.38	Gray	P29	8	29	7/8	50
LCD4-14D-L		1/4	1.00	.55	.81	.09	2.63	Gray	P29	8	29	7/8	50
LCD4-38D-L		3/8	1.00	.62	.81	.08	2.85	Gray	P29	8	29	7/8	50
LCD2-14A-Q	#2 AWG	1/4	.63	.60	.88	.10	2.40	Brown	P33	10	33	15/16	25
LCD2-14B-Q		1/4	.75	.60	.88	.10	2.52	Brown	P33	10	33	15/16	25
LCD2-14D-Q		1/4	1.00	.60	.88	.10	2.77	Brown	P33	10	33	15/16	25
LCD2-56B-Q		5/16	.75	.66	.88	.10	2.65	Brown	P33	10	33	15/16	25
LCD2-38D-Q		3/8	1.00	.66	.88	.10	3.00	Brown	P33	10	33	15/16	25
LCD2-12-Q		1/2	1.75	.75	.88	.08	4.14	Brown	P33	10	33	15/16	25

Chart continues on page F32

System Overview



Code Conductor, Two-Hole, Standard Barrel with Window Lug (continued)

Terminals

Disconnects

Splices

Ferrules

Compression Connectors

Crimping Tools

Mechanical Connectors

Grounding Connectors

Support Products

Technical Info

Index

Part Number	Copper Conductor Size	Stud Hole Size (In.)	Stud Hole Spacing (In.)	Figure Dimensions (In.)				PANDUIT [®] Color Code	PANDUIT [®] Die Index No.‡	Burndy Die Index No.‡	T&B Die Index No.‡	Wire Strip Length (In.)	Std. Pkg. Qty.
				W	B	T	L						
LCD1-14A-E	#1 AWG	1/4	.63	.70	.88	.11	2.42	Green	P37	11	37	15/16	20
LCD1-14B-E		1/4	.75	.70	.88	.11	2.54	Green	P37	11	37	15/16	20
LCD1-56C-E		5/16	.88	.70	.88	.11	2.79	Green	P37	11	37	15/16	20
LCD1-38D-E		3/8	1.00	.70	.88	.11	2.99	Green	P37	11	37	15/16	20
LCD1-12-E		1/2	1.75	.75	.88	.09	4.16	Green	P37	11	37	15/16	20
LCD1/0-14A-X	1/0 AWG	1/4	.63	.76	.94	.12	2.57	Pink	P42	12	42	1	10
LCD1/0-14B-X		1/4	.75	.76	.94	.12	2.70	Pink	P42	12	42	1	10
LCD1/0-56C-X		5/16	.88	.76	.94	.12	2.88	Pink	P42	12	42	1	10
LCD1/0-38D-X		3/8	1.00	.76	.94	.12	3.08	Pink	P42	12	42	1	10
LCD1/0-12-X		1/2	1.75	.80	.94	.12	4.25	Pink	P42	12	42	1	10
LCD2/0-14A-X	2/0 AWG	1/4	.63	.85	.98	.13	2.70	Black	P45	13	45	1 1/16	10
LCD2/0-14B-X		1/4	.75	.85	.98	.13	2.83	Black	P45	13	45	1 1/16	10
LCD2/0-56C-X		5/16	.88	.85	.98	.13	2.95	Black	P45	13	45	1 1/16	10
LCD2/0-38D-X		3/8	1.00	.85	.98	.13	3.14	Black	P45	13	45	1 1/16	10
LCD2/0-12-X		1/2	1.75	.85	.98	.13	4.30	Black	P45	13	45	1 1/16	10
LCD3/0-14B-X	3/0 AWG	1/4	.75	.96	1.14	.13	3.02	Orange	P50	14	50	1 3/16	10
LCD3/0-56D-X		5/16	1.00	.96	1.14	.13	3.27	Orange	P50	14	50	1 3/16	10
LCD3/0-38D-X		3/8	1.00	.96	1.14	.13	3.33	Orange	P50	14	50	1 3/16	10
LCD3/0-12-X		1/2	1.75	.96	1.14	.13	4.49	Orange	P50	14	50	1 3/16	10
LCD4/0-14B-X	4/0 AWG	1/4	.75	1.06	1.19	.14	3.10	Purple	P54	15	54	1 1/4	10
LCD4/0-38D-X		3/8	1.00	1.06	1.19	.14	3.44	Purple	P54	15	54	1 1/4	10
◆ LCD4/0-12-X		1/2	1.75	1.06	1.19	.14	4.58	Purple	P54	15	54	1 1/4	10
LCD250-38D-X	250 kcmil	3/8	1.00	1.17	1.25	.14	3.54	Yellow	P62	16	62	1 5/16	10
◆ LCD250-12-X		1/2	1.75	1.17	1.25	.14	4.68	Yellow	P62	16	62	1 5/16	10
LCD300-38D-X	300 kcmil	3/8	1.00	1.19	1.44	.16	3.74	White	P66	17	66	1 1/2	10
◆ LCD300-12-X		1/2	1.75	1.19	1.44	.16	4.92	White	P66	17	66	1 1/2	10
LCD350-14B-X	350 kcmil	1/4	.75	1.28	1.44	.17	3.30	Red	P71	18	71	1 1/2	10
LCD350-38D-X		3/8	1.00	1.28	1.44	.17	3.78	Red	P71	18	71	1 1/2	10
LCD350-12E-X		1/2	1.25	1.28	1.44	.17	4.33	Red	P71	18	71	1 1/2	10
◆ LCD350-12-X		1/2	1.75	1.28	1.44	.17	4.96	Red	P71	18	71	1 1/2	10
LCD400-38D-6	400 kcmil	3/8	1.00	1.39	1.50	.18	3.86	Blue	P76	19	76	1 9/16	6
◆ LCD400-12-6		1/2	1.75	1.39	1.50	.18	5.04	Blue	P76	19	76	1 9/16	6
LCD500-14B-6	500 kcmil	1/4	.75	1.54	1.75	.22	3.71	Brown	P87	20	87	1 13/16	6
LCD500-38D-6		3/8	1.00	1.54	1.75	.22	4.19	Brown	P87	20	87	1 13/16	6
LCD500-12E-6		1/2	1.25	1.54	1.75	.22	4.74	Brown	P87	20	87	1 13/16	6
◆ LCD500-12-6		1/2	1.75	1.54	1.75	.22	5.37	Brown	P87	20	87	1 13/16	6
LCD600-38D-6	600 kcmil	3/8	1.00	1.70	1.75	.26	4.24	Green	P94	22	94	1 13/16	6
◆ LCD600-12-6		1/2	1.75	1.70	1.75	.26	5.42	Green	P94	22	94	1 13/16	6
LCD750-38D-6	750 kcmil	3/8	1.00	1.89	1.88	.26	4.71	Black	P106	24	106	1 15/16	6
◆ LCD750-12-6		1/2	1.75	1.89	1.88	.26	5.65	Black	P106	24	106	1 15/16	6
◆ LCD1000-12-3	1000 kcmil	1/2	1.75	2.17	1.88	.32	5.77	White	P125	27	125	1 15/16	3
LCD1000-12E-3	1000 kcmil	1/2	1.25	2.17	1.88	.32	5.27	White	P125	27	125	1 15/16	3

‡See [pages L8, L9 and L10, L11](#) in Technical Info section for tool and die information.
 *Not tested to NEBS Level 3 requirements.
 **Consult cable manufacturer for voltage stress relief instructions with applications greater than 2000 volts.
 ◆NEMA hole sizes and spacing.



Code Conductor, Two-Hole, Standard Barrel with Window Lug, 45° Angle

For Use with Stranded Copper Conductors

Type LCD-H

- Color coded barrels marked with **PANDUIT®** and specified competitor die index numbers for proper crimp die selection
- Inspection window to visually assure full conductor insertion
- Tin plated to inhibit corrosion
- UL Listed for use up to 35KV**, temperature rated 90°C and CSA Certified to 600V when crimped with **PANDUIT®** and specified competitor crimping tools and dies
- UL Listed and CSA Certified for wire range-taking capability when crimped with **PANDUIT® UNI-DIE™** dieless crimping tools‡
- **Tested by Telcordia — meets NEBS Level 3**
- Available with NEMA hole sizes and spacing

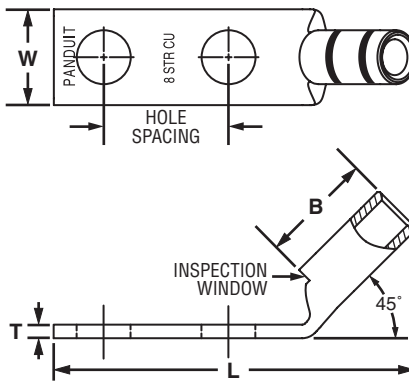

Part Number	Copper Conductor Size	Stud Hole Size (In.)	Stud Hole Spacing (In.)	Figure Dimensions (In.)				PANDUIT® Color Code	PANDUIT® Die Index No.‡	Burndy Die Index No.‡	T&B Die Index No.‡	Wire Strip Length (In.)	Std. Pkg. Qty.
				W	B	T	L						
LCD10-10AH-L*	#14 – #10	#10	.63	.38	.38	.06	1.59	—	—	—	—	7/16	50
LCD10-14AH-L*	AWG STR	1/4	.63	.42	.38	.05	1.67	—	—	—	—	7/16	50
LCD10-38DH-L*	#12 – #10 AWG SOL	3/8	1.00	.56	.38	.04	2.28	—	—	—	—	7/16	50
LCD8-10AH-L	#8 AWG	#10	.63	.41	.56	.08	1.73	Red	P21	49	21	5/8	50
LCD8-14AH-L		1/4	.63	.48	.56	.07	1.81	Red	P21	49	21	5/8	50
LCD8-14BH-L		1/4	.75	.48	.56	.07	1.94	Red	P21	49	21	5/8	50
LCD8-14DH-L		1/4	1.00	.48	.56	.07	2.19	Red	P21	49	21	5/8	50
LCD8-38DH-L		3/8	1.00	.63	.56	.05	2.40	Red	P21	49	21	5/8	50
LCD6-10AH-L	#6 AWG	#10	.63	.46	.81	.08	1.92	Blue	P24	7	24	7/8	50
LCD6-10BH-L		#10	.75	.46	.81	.08	2.04	Blue	P24	7	24	7/8	50
LCD6-10DH-L		#10	1.00	.46	.81	.08	2.29	Blue	P24	7	24	7/8	50
LCD6-14AH-L		1/4	.63	.48	.81	.08	2.00	Blue	P24	7	24	7/8	50
LCD6-14BH-L		1/4	.75	.48	.81	.08	2.13	Blue	P24	7	24	7/8	50
LCD6-14DH-L		1/4	1.00	.48	.81	.08	2.38	Blue	P24	7	24	7/8	50
LCD6-56DH-L		5/16	1.00	.56	.81	.07	2.49	Blue	P24	7	24	7/8	50
LCD6-38DH-L		3/8	1.00	.62	.81	.06	2.59	Blue	P24	7	24	7/8	50
LCD4-10AH-L	#4 – #3 AWG STR, #2 AWG SOL	#10	.63	.55	.81	.09	1.94	Gray	P29	8	29	7/8	50
LCD4-10BH-L		#10	.75	.55	.81	.09	2.06	Gray	P29	8	29	7/8	50
LCD4-14AH-L		1/4	.63	.55	.81	.09	2.03	Gray	P29	8	29	7/8	50
LCD4-14BH-L		1/4	.75	.55	.81	.09	2.15	Gray	P29	8	29	7/8	50
LCD4-14DH-L		1/4	1.00	.55	.81	.09	2.40	Gray	P29	8	29	7/8	50
LCD4-38DH-L			3/8	1.00	.62	.81	.08	2.62	Gray	P29	8	29	7/8

Chart continues on page F34

System Overview



Code Conductor, Two-Hole, Standard Barrel with Window Lug, 45° Angle (continued)

Terminals

Disconnects

Splices

Ferrules

Compression Connectors

Crimping Tools

Mechanical Connectors

Grounding Connectors

Support Products

Technical Info

Index

Part Number	Copper Conductor Size	Stud Hole Size (In.)	Stud Hole Spacing (In.)	Figure Dimensions (In.)				PANDUIT® Color Code	PANDUIT® Die Index No.‡	Burdny Die Index No.‡	T&B Die Index No.‡	Wire Strip Length (In.)	Std. Pkg. Qty.
				W	B	T	L						
LCD2-14AH-Q	#2 AWG	1/4	.63	.60	.88	.10	2.11	Brown	P33	10	33	15/16	25
LCD2-14BH-Q		1/4	.75	.60	.88	.10	2.24	Brown	P33	10	33	15/16	25
LCD2-14DH-Q		1/4	1.00	.60	.88	.10	2.49	Brown	P33	10	33	15/16	25
LCD2-56BH-Q		5/16	.75	.66	.88	.10	2.36	Brown	P33	10	33	15/16	25
LCD2-38DH-Q		3/8	1.00	.66	.88	.10	2.71	Brown	P33	10	33	15/16	25
LCD2-12H-Q		1/2	1.75	.75	.88	.08	3.84	Brown	P33	10	33	15/16	25
LCD1-14AH-E	#1 AWG	1/4	.63	.70	.88	.11	2.12	Green	P37	11	37	15/16	20
LCD1-14BH-E		1/4	.75	.70	.88	.11	2.25	Green	P37	11	37	15/16	20
LCD1-56CH-E		5/16	.88	.70	.88	.11	2.50	Green	P37	11	37	15/16	20
LCD1-38DH-E		3/8	1.00	.70	.88	.11	2.70	Green	P37	11	37	15/16	20
LCD1-12H-E		1/2	1.75	.75	.88	.09	3.87	Green	P37	11	37	15/16	20
LCD1/0-14AH-X	1/0 AWG	1/4	.63	.76	.94	.12	2.26	Pink	P42	12	42	1	10
LCD1/0-14BH-X		1/4	.75	.76	.94	.12	2.38	Pink	P42	12	42	1	10
LCD1/0-56CH-X		5/16	.88	.76	.94	.12	2.56	Pink	P42	12	42	1	10
LCD1/0-38DH-X		3/8	1.00	.76	.94	.12	2.76	Pink	P42	12	42	1	10
LCD1/0-12H-X		1/2	1.75	.80	.94	.12	3.93	Pink	P42	12	42	1	10
LCD2/0-14AH-X	2/0 AWG	1/4	.63	.85	.98	.13	2.39	Black	P45	13	45	1 1/16	10
LCD2/0-14BH-X		1/4	.75	.85	.98	.13	2.52	Black	P45	13	45	1 1/16	10
LCD2/0-56CH-X		5/16	.88	.85	.98	.13	2.64	Black	P45	13	45	1 1/16	10
LCD2/0-38DH-X		3/8	1.00	.85	.98	.13	2.83	Black	P45	13	45	1 1/16	10
LCD2/0-12H-X		1/2	1.75	.85	.98	.13	3.99	Black	P45	13	45	1 1/16	10
LCD3/0-14BH-X	3/0 AWG	1/4	.75	.96	1.14	.13	2.65	Orange	P50	14	50	1 3/16	10
LCD3/0-56DH-X		5/16	1.00	.96	1.14	.13	2.90	Orange	P50	14	50	1 3/16	10
LCD3/0-38DH-X		3/8	1.00	.96	1.14	.13	2.96	Orange	P50	14	50	1 3/16	10
LCD3/0-12H-X		1/2	1.75	.96	1.14	.13	4.12	Orange	P50	14	50	1 3/16	10
LCD4/0-14BH-X	4/0 AWG	1/4	.75	1.06	1.19	.14	2.72	Purple	P54	15	54	1 1/4	10
LCD4/0-38DH-X		3/8	1.00	1.06	1.19	.14	3.05	Purple	P54	15	54	1 1/4	10
LCD4/0-12H-X		1/2	1.75	1.06	1.19	.14	4.19	Purple	P54	15	54	1 1/4	10
LCD250-38DH-X	250 kcmil	3/8	1.00	1.17	1.25	.14	3.13	Yellow	P62	16	62	1 5/16	10
LCD250-12H-X		1/2	1.75	1.17	1.25	.14	4.27	Yellow	P62	16	62	1 5/16	10
LCD300-38DH-X	300 kcmil	3/8	1.00	1.17	1.44	.14	3.36	White	P66	17	66	1 1/2	10
LCD300-12H-X		1/2	1.75	1.17	1.44	.14	4.54	White	P66	17	66	1 1/2	10
LCD350-14BH-X	350 kcmil	1/4	.75	1.28	1.44	.17	2.92	Red	P71	18	71	1 1/2	10
LCD350-38DH-X		3/8	1.00	1.28	1.44	.17	3.40	Red	P71	18	71	1 1/2	10
LCD350-12EH-X		1/2	1.25	1.28	1.44	.17	3.95	Red	P71	18	71	1 1/2	10
LCD350-12H-X		1/2	1.75	1.28	1.44	.17	4.58	Red	P71	18	71	1 1/2	10
LCD400-38DH-6	400 kcmil	3/8	1.00	1.39	1.50	.18	3.50	Blue	P76	19	76	1 9/16	6
LCD400-12H-6		1/2	1.75	1.39	1.50	.18	4.68	Blue	P76	19	76	1 9/16	6
LCD500-14BH-6	500 kcmil	1/4	.75	1.54	1.75	.22	3.27	Brown	P87	20	87	1 13/16	6
LCD500-38DH-6		3/8	1.00	1.54	1.75	.22	3.75	Brown	P87	20	87	1 13/16	6
LCD500-12EH-6		1/2	1.25	1.54	1.75	.22	4.30	Brown	P87	20	87	1 13/16	6
LCD500-12H-6		1/2	1.75	1.54	1.75	.22	4.93	Brown	P87	20	87	1 13/16	6
LCD600-38DH-6	600 kcmil	3/8	1.00	1.70	1.75	.26	3.81	Green	P94	22	94	1 13/16	6
LCD600-12H-6		1/2	1.75	1.70	1.75	.26	4.99	Green	P94	22	94	1 13/16	6

‡See [pages L8, L9 and L10, L11](#) in Technical Info section for tool and die information.
 *Not tested to NEBS Level 3 requirements.
 **Consult cable manufacturer for voltage stress relief instructions with applications greater than 2000 volts.
 ◆NEMA hole sizes and spacing.



Code Conductor, Two-Hole, Standard Barrel with Window Lug, 90° Angle

For Use with Stranded Copper Conductors

Type LCD-F

- Color coded barrels marked with **PANDUIT®** and specified competitor die index numbers for proper crimp die selection
- Inspection window to visually assure full conductor insertion
- Tin plated to inhibit corrosion
- UL Listed for use up to 35KV**, temperature rated 90°C and CSA Certified to 600V when crimped with **PANDUIT®** and specified competitor crimping tools and dies
- UL Listed and CSA Certified for wire range-taking capability when crimped with **PANDUIT® UNI-DIE™** dieless crimping tools‡
- **Tested by Telcordia — meets NEBS Level 3**
- Available with NEMA hole sizes and spacing

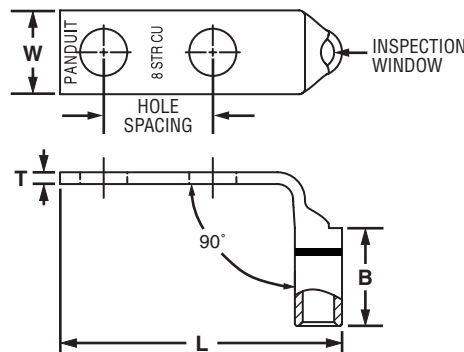

Part Number	Copper Conductor Size	Stud Hole Size (In.)	Stud Hole Spacing (In.)	Figure Dimensions (In.)				PANDUIT® Color Code	PANDUIT® Die Index No.‡	Burdny Die Index No.‡	T&B Die Index No.‡	Wire Strip Length (In.)	Std. Pkg. Qty.
				W	B	T	L						
LCD10-10AF-L*	#14 – #10	#10	.63	.38	.38	.06	1.47	—	—	—	—	7/16	50
LCD10-14AF-L*	AWG STR	1/4	.63	.42	.38	.05	1.56	—	—	—	—	7/16	50
LCD10-38DF-L*	#12 – #10 AWG SOL	3/8	1.00	.56	.38	.04	2.16	—	—	—	—	7/16	50
LCD8-10AF-L	#8 AWG	#10	.63	.41	.56	.08	1.53	Red	P21	49	21	5/8	50
LCD8-14AF-L		1/4	.63	.48	.56	.07	1.62	Red	P21	49	21	5/8	50
LCD8-14BF-L		1/4	.75	.48	.56	.07	1.74	Red	P21	49	21	5/8	50
LCD8-14DF-L		1/4	1.00	.48	.56	.07	1.99	Red	P21	49	21	5/8	50
LCD8-38DF-L		3/8	1.00	.63	.56	.05	2.21	Red	P21	49	21	5/8	50
LCD6-10AF-L	#6 AWG	#10	.63	.46	.81	.08	1.57	Blue	P24	7	24	7/8	50
LCD6-10BF-L		#10	.75	.46	.81	.08	1.69	Blue	P24	7	24	7/8	50
LCD6-10DF-L		#10	1.00	.46	.81	.08	1.94	Blue	P24	7	24	7/8	50
LCD6-14AF-L		1/4	.63	.48	.81	.08	1.66	Blue	P24	7	24	7/8	50
LCD6-14BF-L		1/4	.75	.48	.81	.08	1.78	Blue	P24	7	24	7/8	50
LCD6-14DF-L		1/4	1.00	.48	.81	.08	2.03	Blue	P24	7	24	7/8	50
LCD6-56DF-L		5/16	1.00	.56	.81	.07	2.15	Blue	P24	7	24	7/8	50
LCD6-38DF-L	3/8	1.00	.62	.81	.06	2.25	Blue	P24	7	24	7/8	50	
LCD4-10AF-L	#4 – #3 AWG STR, #2 AWG SOL	#10	.63	.55	.81	.09	1.65	Gray	P29	8	29	7/8	50
LCD4-10BF-L		#10	.75	.55	.81	.09	1.78	Gray	P29	8	29	7/8	50
LCD4-14AF-L		1/4	.63	.55	.81	.09	1.74	Gray	P29	8	29	7/8	50
LCD4-14BF-L		1/4	.75	.55	.81	.09	1.87	Gray	P29	8	29	7/8	50
LCD4-14DF-L		1/4	1.00	.55	.81	.09	2.12	Gray	P29	8	29	7/8	50
LCD4-38DF-L		3/8	1.00	.62	.81	.08	2.34	Gray	P29	8	29	7/8	50

Chart continues on page F36

System Overview



Code Conductor, Two-Hole, Standard Barrel with Window Lug, 90° Angle (continued)

Terminals

Disconnects

Splices

Ferrules

Compression Connectors

Crimping Tools

Mechanical Connectors

Grounding Connectors

Support Products

Technical Info

Index

Part Number	Copper Conductor Size	Stud Hole Size (In.)	Stud Hole Spacing (In.)	Figure Dimensions (In.)				PANDUIT® Color Code	PANDUIT® Die Index No.‡	Burdny Die Index No.‡	T&B Die Index No.‡	Wire Strip Length (In.)	Std. Pkg. Qty.
				W	B	T	L						
LCD2-14AF-Q	#2 AWG	1/4	.63	.60	.88	.10	1.86	Brown	P33	10	33	15/16	25
LCD2-14BF-Q		1/4	.75	.60	.88	.10	1.99	Brown	P33	10	33	15/16	25
LCD2-14DF-Q		1/4	1.00	.60	.88	.10	2.24	Brown	P33	10	33	15/16	25
LCD2-56BF-Q		5/16	.75	.66	.88	.10	2.11	Brown	P33	10	33	15/16	25
LCD2-38DF-Q		3/8	1.00	.66	.88	.10	2.47	Brown	P33	10	33	15/16	25
LCD2-12F-Q		1/2	1.75	.75	.88	.08	3.61	Brown	P33	10	33	15/16	25
LCD1-14AF-E	#1 AWG	1/4	.63	.70	.88	.11	1.94	Green	P37	11	37	15/16	20
LCD1-14BF-E		1/4	.75	.70	.88	.11	2.06	Green	P37	11	37	15/16	20
LCD1-56CF-E		5/16	.88	.70	.88	.11	2.31	Green	P37	11	37	15/16	20
LCD1-38DF-E		3/8	1.00	.70	.88	.11	2.51	Green	P37	11	37	15/16	20
LCD1-12F-E		1/2	1.75	.75	.88	.09	3.68	Green	P37	11	37	15/16	20
LCD1/0-14AF-X	1/0 AWG	1/4	.63	.76	.94	.12	2.08	Pink	P42	12	42	1	10
LCD1/0-14BF-X		1/4	.75	.76	.94	.12	2.20	Pink	P42	12	42	1	10
LCD1/0-56CF-X		5/16	.88	.76	.94	.12	2.38	Pink	P42	12	42	1	10
LCD1/0-38DF-X		3/8	1.00	.76	.94	.12	2.58	Pink	P42	12	42	1	10
LCD1/0-12F-X		1/2	1.75	.80	.94	.12	3.75	Pink	P42	12	42	1	10
LCD2/0-14AF-X	2/0 AWG	1/4	.63	.85	.98	.13	2.22	Black	P45	13	45	1 1/16	10
LCD2/0-14BF-X		1/4	.75	.85	.98	.13	2.34	Black	P45	13	45	1 1/16	10
LCD2/0-56CF-X		5/16	.88	.85	.98	.13	2.47	Black	P45	13	45	1 1/16	10
LCD2/0-38DF-X		3/8	1.00	.85	.98	.13	2.66	Black	P45	13	45	1 1/16	10
LCD2/0-12F-X		1/2	1.75	.85	.98	.13	3.82	Black	P45	13	45	1 1/16	10
LCD3/0-14BF-X	3/0 AWG	1/4	.75	.96	1.14	.13	2.42	Orange	P50	14	50	1 3/16	10
LCD3/0-56DF-X		5/16	1.00	.96	1.14	.13	2.67	Orange	P50	14	50	1 3/16	10
LCD3/0-38DF-X		3/8	1.00	.96	1.14	.13	2.73	Orange	P50	14	50	1 3/16	10
LCD3/0-12F-X		1/2	1.75	.96	1.14	.13	3.89	Orange	P50	14	50	1 3/16	10
LCD4/0-14BF-X	4/0 AWG	1/4	.75	1.06	1.19	.14	2.50	Purple	P54	15	54	1 1/4	10
LCD4/0-38DF-X		3/8	1.00	1.06	1.19	.14	2.84	Purple	P54	15	54	1 1/4	10
LCD4/0-12F-X		1/2	1.75	1.06	1.19	.14	3.98	Purple	P54	15	54	1 1/4	10
LCD250-38DF-X	250 kcmil	3/8	1.00	1.17	1.25	.14	2.90	Yellow	P62	16	62	1 5/16	10
LCD250-12F-X		1/2	1.75	1.17	1.25	.14	4.04	Yellow	P62	16	62	1 5/16	10
LCD300-38DF-X	300 kcmil	3/8	1.00	1.19	1.44	.16	2.88	White	P66	17	66	1 1/2	10
LCD300-12F-X		1/2	1.75	1.19	1.44	.16	4.06	White	P66	17	66	1 1/2	10
LCD350-14BF-X	350 kcmil	1/4	.75	1.28	1.44	.17	2.46	Red	P71	18	71	1 1/2	10
LCD350-38DF-X		3/8	1.00	.28	1.44	.17	2.94	Red	P71	18	71	1 1/2	10
LCD350-12EF-X		1/2	1.25	1.28	1.44	.17	3.49	Red	P71	18	71	1 1/2	10
LCD350-12F-X		1/2	1.75	1.28	1.44	.17	4.12	Red	P71	18	71	1 1/2	10
LCD400-38DF-6	400 kcmil	3/8	1.00	1.39	1.50	.18	3.02	Blue	P76	19	76	1 9/16	6
LCD400-12F-6		1/2	1.75	1.39	1.50	.18	4.20	Blue	P76	19	76	1 9/16	6
LCD500-14BF-6	500 kcmil	1/4	.75	1.54	1.75	.22	2.65	Brown	P87	20	87	1 13/16	6
LCD500-38DF-6		3/8	1.00	1.54	1.75	.22	3.13	Brown	P87	20	87	1 13/16	6
LCD500-12EF-6		1/2	1.25	1.54	1.75	.22	3.68	Brown	P87	20	87	1 13/16	6
LCD500-12F-6		1/2	1.75	1.54	1.75	.22	4.31	Brown	P87	20	87	1 13/16	6
LCD600-38DF-6	600 kcmil	3/8	1.00	1.70	1.75	.26	3.26	Green	P94	22	94	1 13/16	6
LCD600-12F-6		1/2	1.75	1.70	1.75	.26	4.44	Green	P94	22	94	1 13/16	6

‡See [pages L8, L9 and L10, L11](#) in Technical Info section for tool and die information.

*Not tested to NEBS Level 3 requirements.

**Consult cable manufacturer for voltage stress relief instructions with applications greater than 2000 volts.

◆NEMA hole sizes and spacing.

NEW!



Code Conductor, Two-Hole, Standard Barrel with Window, Narrow Tongue Lug

For Use with Stranded Copper Conductors

Type LCDN

- Narrow tongue width for limited space applications
- Color coded barrels marked with **PANDUIT®** and specified competitor die index numbers for proper crimp die selection
- Inspection window to visually assure full conductor insertion
- Tin plated to inhibit corrosion
- UL Listed for use up to 35KV**, temperature rated 90°C and CSA Certified to 600V when crimped with **PANDUIT®** and specified competitor crimping tools and dies
- UL Listed and CSA Certified for wire range-taking capability when crimped with **PANDUIT® UNI-DIE™** dieless crimping tools‡

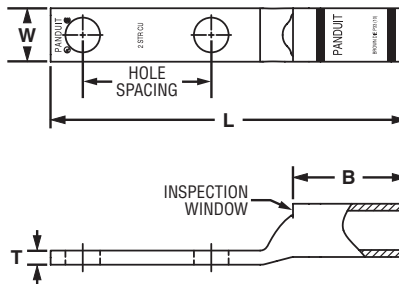

Part Number	Copper Conductor Size	Stud Hole Size (In.)	Stud Hole Spacing (In.)	Figure Dimensions (In.)				PANDUIT® Color Code	PANDUIT® Die Index No.‡	Burdny Die Index No.‡	T&B Die Index No.‡	Wire Strip Length (In.)	Std. Pkg. Qty.
				W	B	T	L						
LCDN2-14A-Q	#2 AWG	1/4	.63	.42	.88	.10	2.40	Brown	P33	10	33	15/16	25
LCDN2-14B-Q		1/4	.75	.42	.88	.10	2.52	Brown	P33	10	33	15/16	25
LCDN2-14D-Q		1/4	1.00	.42	.88	.11	2.77	Brown	P33	10	33	15/16	25
LCDN1-14B-E	#1 AWG	1/4	.75	.47	.88	.11	2.54	Green	P37	11	37	15/16	20
LCDN1/0-14D-X	1/0 AWG	1/4	1.00	.52	.94	.12	2.95	Pink	P42	12	42	1	10
LCDN1/0-56D-X		5/16	1.00	.52	.94	.12	3.00	Pink	P42	12	42	1	10
LCDN2/0-14A-X	2/0 AWG	1/4	.63	.58	.98	.13	2.71	Black	P45	13	45	1 1/16	10
LCDN2/0-14D-X		1/4	1.00	.58	.98	.13	3.09	Black	P45	13	45	1 1/16	10
LCDN2/0-56A-X		5/16	.63	.58	.98	.13	2.71	Black	P45	13	45	1 1/16	10
LCDN2/0-56D-X		5/16	1.00	.58	.98	.13	3.09	Black	P45	13	45	1 1/16	10
LCDN350-38D-X	350 kcmil	3/8	1.00	.88	1.44	.17	3.79	Red	P71	18	71	1 1/2	10
LCDN500-38D-6	500 kcmil	3/8	1.00	1.06	1.75	.22	4.20	Brown	P87	20	87	1 13/16	6
LCDN500-12D-6		1/2	1.00	1.06	1.75	.22	4.63	Brown	P87	20	87	1 13/16	6
LCDN750-38D-6	750 kcmil	3/8	1.00	1.30	1.88	.26	4.72	Black	P106	24	106	1 15/16	6
LCDN750-12D-6		1/2	1.00	1.30	1.88	.26	4.91	Black	P106	24	106	1 15/16	6

‡See [pages L8, L9 and L10, L11](#) in Technical Info section for tool and die information.

**Consult cable manufacturer for voltage stress relief instructions with applications greater than 2000 volts.

System Overview

Terminals

Disconnects

Splices

Ferrules

Compression Connectors

Crimping Tools

Mechanical Connectors

Grounding Connectors

Support Products

Technical Info

Index

System Overview

NEW!



Code, Two-Hole, Standard Barrel with Window, Narrow Tongue Lug, 45°

For Use with Stranded Copper Conductors

Type LCDN-H

- Narrow tongue width for limited space applications
- Color coded barrels marked with **PANDUIT®** and specified competitor die index numbers for proper crimp die selection
- Inspection window to visually assure full conductor insertion
- Tin plated to inhibit corrosion

- UL Listed for use up to 35KV**, temperature rated 90°C and CSA Certified to 600V when crimped with **PANDUIT®** and specified competitor crimping tools and dies
- UL Listed and CSA Certified for wire range-taking capability when crimped with **PANDUIT® UNI-DIE™** dieless crimping tools‡

Disconnects

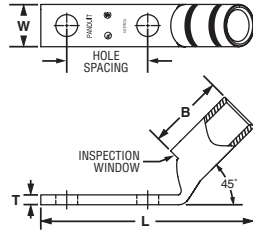

Splices

Ferrules

Part Number	Copper Conductor Size	Stud Hole Size (In.)	Stud Hole Spacing (In.)	Figure Dimensions (In.)				PANDUIT® Color Code	PANDUIT® Die Index No.‡	Burdny Die Index No.‡	T&B Die Index No.‡	Wire Strip Length (In.)	Std. Pkg. Qty.
				W	B	T	L						
LCDN2-14AH-Q	#2 AWG	1/4	.63	.42	.88	.10	2.11	Brown	P33	10	33	15/16	25
LCDN2-14DH-Q	#2 AWG	1/4	1.00	.42	.88	.10	2.49	Brown	P33	10	33	15/16	25
LCDN1/0-14DH-X	1/0 AWG	1/4	1.00	.52	.94	.12	2.63	Pink	P42	12	42	1	10
LCDN1/0-56DH-X	1/0 AWG	5/16	1.00	.52	.94	.12	2.69	Pink	P42	12	42	1	10
LCDN750-38DH-6	750 kcmil	3/8	1.00	1.30	1.88	.26	4.25	Black	P106	24	106	1 15/16	6
LCDN750-12DH-6	750 kcmil	1/2	1.00	1.30	1.88	.26	4.43	Black	P106	24	106	1 15/16	6

‡ See [pages L8, L9 and L10, L11](#) in Technical Info section for tool and die information.

**Consult cable manufacturer for voltage stress relief instructions with applications greater than 2000 volts.

Crimping Tools

NEW!



Code, Two-Hole, Standard Barrel with Window, Narrow Tongue Lug, 90°

For Use with Stranded Copper Conductors

Type LCDN-F

- Narrow tongue width for limited space applications
- Color coded barrels marked with **PANDUIT®** and specified competitor die index numbers for proper crimp die selection
- Inspection window to visually assure full conductor insertion
- Tin plated to inhibit corrosion

- UL Listed for use up to 35KV**, temperature rated 90°C and CSA Certified to 600V when crimped with **PANDUIT®** and specified competitor crimping tools and dies
- UL Listed and CSA Certified for wire range-taking capability when crimped with **PANDUIT® UNI-DIE™** dieless crimping tools‡

Grounding Connectors

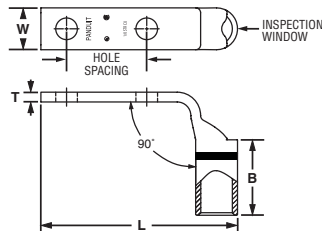

Support Products

Technical Info

Part Number	Copper Conductor Size	Stud Hole Size (In.)	Stud Hole Spacing (In.)	Figure Dimensions (In.)				PANDUIT® Color Code	PANDUIT® Die Index No.‡	Burdny Die Index No.‡	T&B Die Index No.‡	Wire Strip Length (In.)	Std. Pkg. Qty.
				W	B	T	L						
LCDN2-14AF-Q	#2 AWG	1/4	.63	.42	.88	.10	1.86	Brown	P33	10	33	15/16	25
LCDN2-14DF-Q	#2 AWG	1/4	1.00	.42	.88	.10	2.24	Brown	P33	10	33	15/16	25
LCDN1/0-14DF-X	1/0 AWG	1/4	1.00	.52	.94	.12	2.45	Pink	P42	12	42	1	10
LCDN1/0-56DF-X	1/0 AWG	5/16	1.00	.52	.94	.12	2.51	Pink	P42	12	42	1	10
LCDN750-38DF-6	750 kcmil	3/8	1.00	1.30	1.88	.26	3.56	Black	P106	24	106	1 15/16	6
LCDN750-12DF-6	750 kcmil	1/2	1.00	1.30	1.88	.26	3.75	Black	P106	24	106	1 15/16	6

‡ See [pages L8, L9 and L10, L11](#) in Technical Info section for tool and die information.

**Consult cable manufacturer for voltage stress relief instructions with applications greater than 2000 volts.



Code Conductor, Long Blank Tongue, Standard Barrel with Window Lug

For Use with Stranded Copper Conductors

Type LCD-00

- Color coded barrels marked with **PANDUIT®** and specified competitor die index numbers for proper crimp die selection
- Inspection window to visually assure full conductor insertion
- Tin plated to inhibit corrosion
- UL Recognized for use up to 35KV**, temperature rated 90°C and CSA Certified to 600V when crimped with **PANDUIT®** and specified competitor crimping tools and dies

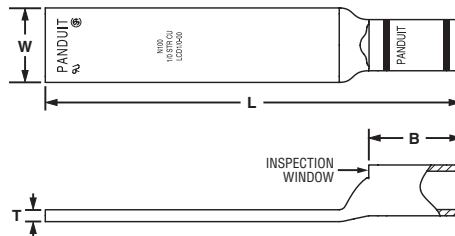

Part Number	Copper Conductor Size	Figure Dimensions (In.)				PANDUIT® Color Code	PANDUIT® Die Index No.‡	Burndy Die Index No.‡	T&B Die Index No.‡	Wire Strip Length (In.)	Std. Pkg. Qty.
		W	B	T	L						
LCD1/0-00-X	1/0 AWG	.76	.94	.12	4.25	Pink	P42	12	42	1	10
LCD2/0-00-X	2/0 AWG	.85	.98	.13	4.30	Black	P45	13	45	1 1/16	10
LCD3/0-00-X	3/0 AWG	.96	1.14	.13	4.50	Orange	P50	14	50	1 3/16	10
LCD4/0-00-X	4/0 AWG	1.06	1.19	.14	4.58	Purple	P54	15	54	1 1/4	10
LCD250-00-X	250 kcmil	1.17	1.25	.14	4.69	Yellow	P62	16	62	1 5/16	10
LCD300-00-X	300 kcmil	1.19	1.44	.16	4.93	White	P66	17	66	1 1/2	10
LCD350-00-X	350 kcmil	1.28	1.44	.17	4.97	Red	P71	18	71	1 1/2	10
LCD400-00-6	400 kcmil	1.39	1.50	.18	5.05	Blue	P76	19	76	1 9/16	6
LCD500-00-6	500 kcmil	1.54	1.75	.22	5.38	Brown	P87	20	87	1 13/16	6
LCD600-00-6	600 kcmil	1.70	1.75	.26	5.43	Green	P94	22	94	1 13/16	6
LCD750-00-6	750 kcmil	1.89	1.88	.26	5.65	Black	P106	24	106	1 15/16	6
LCD1000-00-3	1000 kcmil	2.17	1.88	.32	5.77	White	P125	27	125	1 15/16	3

‡See [pages L8, L9 and L10, L11](#) in Technical Info section for tool and die information.

**Consult cable manufacturer for voltage stress relief instructions with applications greater than 2000 volts.

System Overview

Terminals

Disconnects

Splices

Ferrules

Compression Connectors

Crimping Tools

Mechanical Connectors

Grounding Connectors

Support Products

Technical Info

Index

System Overview



Code Conductor, Two-Hole, Long Barrel Lug

For Use with Stranded Copper Conductors

Type LCC

Terminals

- Long barrel maximizes number of crimps and provides premium wire pull-out strength and electrical performance
- Color coded barrels marked with **PANDUIT®** and specified competitor die index numbers for proper crimp die selection
- Enclosed barrel prevents corrosive material from entering barrel when used in harsh environments
- Tin plated to inhibit corrosion

- UL Listed for use up to 35KV**, temperature rated 90°C and CSA Certified to 600V when crimped with **PANDUIT®** and specified competitor crimping tools and dies
- UL Listed and CSA Certified for wire range-taking capability when crimped with **PANDUIT® UNI-DIE™** dieless crimping tools‡
- **Tested by Telcordia — meets NEBS Level 3**
- Available with NEMA hole sizes and spacing

Disconnects

Splices

Ferrules

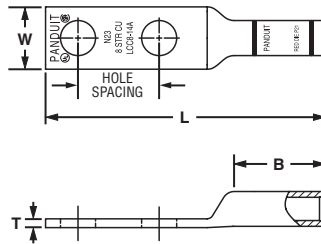

Figure 1

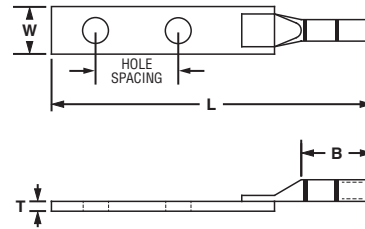

Figure 2: Two Piece Brazed Tongue Construction

Part Number	Figure No.	Copper Conductor Size	Stud Hole Size (In.)	Stud Hole Spacing (In.)	Figure Dimensions (In.)				PANDUIT® Color Code	PANDUIT® Die Index No.‡	Burdny Die Index No.‡	T&B Die Index No.‡	Wire Strip Length (In.)	Std. Pkg. Qty.
					W	B	T	L						
LCC8-10A-L	1	#8 AWG	#10	.63	.41	.70	.08	2.07	Red	P21	49	21	3/4	50
LCC8-14A-L	1		1/4	.63	.48	.70	.07	2.16	Red	P21	49	21	3/4	50
LCC8-14B-L	1		1/4	.75	.48	.70	.07	2.28	Red	P21	49	21	3/4	50
LCC8-14D-L	1		1/4	1.00	.48	.70	.07	2.53	Red	P21	49	21	3/4	50
LCC8-38D-L	1		3/8	1.00	.60	.70	.05	2.75	Red	P21	49	21	3/4	50
LCC6-10A-L	1	#6 AWG	#10	.63	.46	1.07	.08	2.47	Blue	P24	7	24	1 1/8	50
LCC6-14A-L	1		1/4	.63	.48	1.07	.08	2.56	Blue	P24	7	24	1 1/8	50
LCC6-14B-L	1		1/4	.75	.48	1.07	.08	2.68	Blue	P24	7	24	1 1/8	50
LCC6-14D-L	1		1/4	1.00	.48	1.07	.08	2.93	Blue	P24	7	24	1 1/8	50
LCC6-38D-L	1		3/8	1.00	.62	1.07	.06	3.15	Blue	P24	7	24	1 1/8	50
LCC6-12-L	2		1/2	1.75	.81	1.13	.16	4.48	Blue	P24	7	24	1 3/16	50
LCC4-14A-L	1	#4 – #3 AWG STR, #2 AWG SOL	1/4	.63	.55	1.05	.09	2.58	Gray	P29	8	29	1 1/8	50
LCC4-14B-L	1		1/4	.75	.55	1.05	.09	2.70	Gray	P29	8	29	1 1/8	50
LCC4-38D-L	1		3/8	1.00	.62	1.05	.08	3.17	Gray	P29	8	29	1 1/8	50
LCC4-12-L	2		1/2	1.75	.84	1.13	.16	4.50	Gray	P29	8	29	1 1/16	50
LCC2-14A-Q	1	#2 AWG	1/4	.63	.60	1.16	.10	2.77	Brown	P33	10	33	1 1/4	25
LCC2-14B-Q	1		1/4	.75	.60	1.16	.10	2.89	Brown	P33	10	33	1 1/4	25
LCC2-56B-Q	1		5/16	.75	.66	1.16	.10	3.02	Brown	P33	10	33	1 1/4	25
LCC2-56C-Q	1		5/16	.88	.66	1.16	.10	3.14	Brown	P33	10	33	1 1/4	25
LCC2-38D-Q	1		3/8	1.00	.66	1.16	.10	3.34	Brown	P33	10	33	1 1/4	25
LCC2-38-Q	1		3/8	1.75	.66	1.16	.10	4.09	Brown	P33	10	33	1 1/4	25
LCC2-12-Q	1		1/2	1.75	.75	1.16	.08	4.51	Brown	P33	10	33	1 1/4	25
LCC1-14A-E	1	#1 AWG	1/4	.63	.70	1.36	.11	3.00	Green	P37	11	37	1 7/16	20
LCC1-14B-E	1		1/4	.75	.70	1.36	.11	3.12	Green	P37	11	37	1 7/16	20
LCC1-56B-E	1		5/16	.75	.70	1.36	.11	3.25	Green	P37	11	37	1 7/16	20
LCC1-56C-E	1		5/16	.88	.70	1.36	.11	3.37	Green	P37	11	37	1 7/16	20
LCC1-38D-E	1		3/8	1.00	.70	1.36	.11	3.57	Green	P37	11	37	1 7/16	20
LCC1-12-E	1		1/2	1.75	.75	1.36	.09	4.74	Green	P37	11	37	1 7/16	20

PANDUIT® TERMINATION SOLUTIONS



Code Conductor, Two-Hole, Long Barrel Lug (continued)

Part Number	Figure No.	Copper Conductor Size	Stud Hole Size (In.)	Stud Hole Spacing (In.)	Figure Dimensions (In.)				PANDUIT® Color Code	PANDUIT® Die Index No.‡	Burdny Die Index No.‡	T&B Die Index No.‡	Wire Strip Length (In.)	Std. Pkg. Qty.
					W	B	T	L						
LCC1/0-14A-X	1	1/0 AWG	1/4	.63	.76	1.44	.12	3.18	Pink	P42	12	42	1 1/2	10
LCC1/0-14B-X	1		1/4	.75	.76	1.44	.12	3.31	Pink	P42	12	42	1 1/2	10
LCC1/0-56C-X	1		5/16	.88	.76	1.44	.12	3.49	Pink	P42	12	42	1 1/2	10
LCC1/0-56D-X	1		5/16	1.00	.76	1.44	.12	3.61	Pink	P42	12	42	1 1/2	10
LCC1/0-38D-X	1		3/8	1.00	.76	1.44	.12	3.69	Pink	P42	12	42	1 1/2	10
LCC1/0-12D-X	1		1/2	1.00	.80	1.44	.12	3.95	Pink	P42	12	42	1 1/2	10
LCC1/0-12-X	1		1/2	1.75	.80	1.44	.12	4.86	Pink	P42	12	42	1 1/2	10
LCC2/0-14A-X	1	2/0 AWG	1/4	.63	.85	1.50	.13	3.38	Black	P45	13	45	1 9/16	10
LCC2/0-14B-X	1		1/4	.75	.85	1.50	.13	3.51	Black	P45	13	45	1 9/16	10
LCC2/0-56D-X	1		5/16	1.00	.85	1.50	.13	3.76	Black	P45	13	45	1 9/16	10
LCC2/0-38D-X	1		3/8	1.00	.85	1.50	.13	3.82	Black	P45	13	45	1 9/16	10
LCC2/0-12D-X	1		1/2	1.00	.85	1.50	.13	4.07	Black	P45	13	45	1 9/16	10
LCC2/0-12-X	1		1/2	1.75	.85	1.50	.13	4.98	Black	P45	13	45	1 9/16	10
LCC3/0-14B-X	1	3/0 AWG	1/4	.75	.96	1.50	.13	3.56	Orange	P50	14	50	1 9/16	10
LCC3/0-38D-X	1		3/8	1.00	.96	1.50	.13	3.87	Orange	P50	14	50	1 9/16	10
LCC3/0-12D-X	1		1/2	1.00	.96	1.50	.13	4.12	Orange	P50	14	50	1 9/16	10
LCC3/0-12-X	1		1/2	1.75	.96	1.50	.13	5.03	Orange	P50	14	50	1 9/16	10
LCC4/0-14B-X	1	4/0 AWG	1/4	.75	1.06	1.56	.14	3.66	Purple	P54	15	54	1 5/8	10
LCC4/0-56D-X	1		5/16	1.00	1.06	1.56	.14	3.92	Purple	P54	15	54	1 5/8	10
LCC4/0-38D-X	1		3/8	1.00	1.06	1.56	.14	3.99	Purple	P54	15	54	1 5/8	10
LCC4/0-38-X	1		3/8	1.75	1.06	1.56	.14	4.74	Purple	P54	15	54	1 5/8	10
LCC4/0-12D-X	1		1/2	1.00	1.06	1.56	.14	4.22	Purple	P54	15	54	1 5/8	10
LCC4/0-12-X	1		1/2	1.75	1.06	1.56	.14	5.13	Purple	P54	15	54	1 5/8	10
LCC250-38D-X	1	250 kcmil	3/8	1.00	1.17	1.60	.14	4.09	Yellow	P62	16	62	1 11/16	10
LCC250-12D-X	1		1/2	1.00	1.17	1.60	.14	4.32	Yellow	P62	16	62	1 11/16	10
LCC250-12-X	1	1/2	1.75	1.17	1.60	.14	5.23	Yellow	P62	16	62	1 11/16	10	
LCC300-38D-X	1	300 kcmil	3/8	1.00	1.19	2.24	.16	4.76	White	P66	17	66	2 5/16	10
LCC300-12-X	1		1/2	1.75	1.19	2.24	.16	5.94	White	P66	17	66	2 5/16	10
LCC350-14B-X	1	350 kcmil	1/4	.75	1.28	2.24	.17	4.33	Red	P71	18	71	2 5/16	10
LCC350-38D-X	1		3/8	1.00	1.28	2.24	.17	4.81	Red	P71	18	71	2 5/16	10
LCC350-12-X	1		1/2	1.75	1.28	2.24	.17	5.99	Red	P71	18	71	2 5/16	10
LCC400-14B-6	1	400 kcmil	1/4	.75	1.39	2.30	.18	4.44	Blue	P76	19	76	2 3/8	6
LCC400-38D-6	1		3/8	1.00	1.39	2.30	.18	4.92	Blue	P76	19	76	2 3/8	6
LCC400-12-6	1		1/2	1.75	1.39	2.30	.18	6.10	Blue	P76	19	76	2 3/8	6
LCC500-14B-6	1	500 kcmil	1/4	.75	1.54	2.50	.22	4.70	Brown	P87	20	87	2 9/16	6
LCC500-38D-6	1		3/8	1.00	1.54	2.50	.22	5.18	Brown	P87	20	87	2 9/16	6
LCC500-12-6	1		1/2	1.75	1.54	2.50	.22	6.36	Brown	P87	20	87	2 9/16	6
LCC600-38D-6	1	600 kcmil	3/8	1.00	1.70	2.69	.26	5.45	Green	P94	22	94	2 3/4	6
LCC600-12-6	1		1/2	1.75	1.70	2.69	.26	6.63	Green	P94	22	94	2 3/4	6
LCC750-38D-6	1	750 kcmil	3/8	1.00	1.89	2.87	.26	6.10	Black	P106	24	106	2 15/16	6
LCC750-12-6	1		1/2	1.75	1.89	2.87	.26	7.04	Black	P106	24	106	2 15/16	6
LCC800-12-6	1	800 kcmil	1/2	1.75	1.95	2.94	.29	7.13	Orange	P107	25	—	3	6
LCC1000-38D-3	1	1000 kcmil	3/8	1.00	2.17	3.00	.32	6.35	White	P125	27	125	3 1/16	3
LCC1000-12-3	1		1/2	1.75	2.17	3.00	.32	7.29	White	P125	27	125	3 1/16	3

‡See pages L12, L13 and L14, L15 in Technical Info section for tool and die information.

**Consult cable manufacturer for voltage stress relief instructions with applications greater than 2000 volts.

◆NEMA hole sizes and spacing

System Overview

Terminals

Disconnects

Splices

Ferrules

Compression Connectors

Crimping Tools

Mechanical Connectors

Grounding Connectors

Support Products

Technical Info

Index

System Overview



Code Conductor, Two-Hole, Long Barrel Lug, 45° Angle

For Use with Stranded Copper Conductors

Type LCC-H

Terminals

- Long barrel maximizes number of crimps and provides premium wire pull-out strength and electrical performance
- Color coded barrels marked with **PANDUIT®** and specified competitor die index numbers for proper crimp die selection
- Enclosed barrel prevents corrosive material from entering barrel when used in harsh environments
- Tin plated to inhibit corrosion

Disconnects

- UL Listed for use up to 35KV**, temperature rated 90°C and CSA Certified to 600V when crimped with **PANDUIT®** and specified competitor crimping tools and dies
- UL Listed and CSA Certified for wire range-taking capability when crimped with **PANDUIT® UNI-DIE™** dieless crimping tools‡
- **Tested by Telcordia — meets NEBS Level 3**
- Available with NEMA hole sizes and spacing

Splices



Ferrules

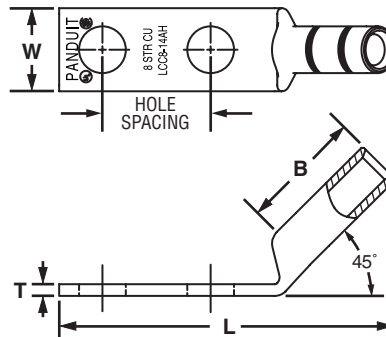

Compression Connectors

Crimping Tools

Mechanical Connectors

Grounding Connectors

Support Products

Technical Info

Index

Part Number	Copper Conductor Size	Stud Hole Size (In.)	Stud Hole Spacing (In.)	Figure Dimensions (In.)				PANDUIT® Color Code	PANDUIT® Die Index No.‡	Burndy Die Index No.‡	T&B Die Index No.‡	Wire Strip Length (In.)	Std. Pkg. Qty.
				W	B	T	L						
LCC8-10AH-L	#8 AWG	#10	.63	.41	.70	.08	1.86	Red	P21	49	21	3/4	50
LCC8-14AH-L		1/4	.63	.48	.70	.07	1.94	Red	P21	49	21	3/4	50
LCC8-14BH-L		1/4	.75	.48	.70	.07	2.06	Red	P21	49	21	3/4	50
LCC8-14DH-L		1/4	1.00	.48	.70	.07	2.31	Red	P21	49	21	3/4	50
LCC8-38DH-L		3/8	1.00	.60	.70	.05	2.52	Red	P21	49	21	3/4	50
LCC6-10AH-L	#6 AWG	#10	.63	.46	1.07	.08	2.14	Blue	P24	7	24	1 1/8	50
LCC6-14AH-L		1/4	.63	.48	1.07	.08	2.23	Blue	P24	7	24	1 1/8	50
LCC6-14BH-L		1/4	.75	.48	1.07	.08	2.35	Blue	P24	7	24	1 1/8	50
LCC6-14DH-L		1/4	1.00	.48	1.07	.08	2.60	Blue	P24	7	24	1 1/8	50
LCC6-38DH-L		3/8	1.00	.62	1.07	.06	2.81	Blue	P24	7	24	1 1/8	50
LCC4-14AH-L	#4 – #3 AWG STR, #2 AWG SOL	1/4	.63	.55	1.05	.09	2.26	Gray	P29	8	29	1 1/8	50
LCC4-14BH-L		1/4	.75	.55	1.05	.09	2.38	Gray	P29	8	29	1 1/8	50
LCC4-38DH-L		3/8	1.00	.62	1.05	.08	2.84	Gray	P29	8	29	1 1/8	50
LCC2-14AH-Q	#2 AWG	1/4	.63	.60	1.16	.10	2.38	Brown	P33	10	33	1 1/4	25
LCC2-14BH-Q		1/4	.75	.60	1.16	.10	2.50	Brown	P33	10	33	1 1/4	25
LCC2-56BH-Q		5/16	.75	.66	1.16	.10	2.62	Brown	P33	10	33	1 1/4	25
LCC2-56CH-Q		5/16	.88	.66	1.16	.10	2.75	Brown	P33	10	33	1 1/4	25
LCC2-38DH-Q		3/8	1.00	.66	1.16	.10	2.95	Brown	P33	10	33	1 1/4	25
LCC2-38H-Q		3/8	1.75	.66	1.16	.10	3.70	Brown	P33	10	33	1 1/4	25
LCC2-12H-Q		1/2	1.75	.75	1.16	.08	4.10	Brown	P33	10	33	1 1/4	25

PANDUIT® TERMINATION SOLUTIONS



Code Conductor, Two-Hole, Long Barrel Lug, 45° Angle (continued)

Part Number	Copper Conductor Size	Stud Hole Size (In.)	Stud Hole Spacing (In.)	Figure Dimensions (In.)				PANDUIT® Color Code	PANDUIT® Die Index No.‡	Burndy Die Index No.‡	T&B Die Index No.‡	Wire Strip Length (In.)	Std. Pkg. Qty.
				W	B	T	L						
LCC1-14AH-E	#1 AWG	1/4	.63	.70	1.36	.11	2.53	Green	P37	11	37	1 7/16	20
LCC1-14BH-E		1/4	.75	.70	1.36	.11	2.66	Green	P37	11	37	1 7/16	20
LCC1-56BH-E		5/16	.75	.70	1.36	.11	2.78	Green	P37	11	37	1 7/16	20
LCC1-56CH-E		5/16	.88	.70	1.36	.11	2.91	Green	P37	11	37	1 7/16	20
LCC1-38DH-E		3/8	1.00	.70	1.36	.11	3.11	Green	P37	11	37	1 7/16	20
LCC1-12H-E		1/2	1.75	.75	1.36	.09	4.27	Green	P37	11	37	1 7/16	20
LCC1/0-14AH-X	1/0 AWG	1/4	.63	.76	1.44	.12	2.69	Pink	P42	12	42	1 1/2	10
LCC1/0-14BH-X		1/4	.75	.76	1.44	.12	2.81	Pink	P42	12	42	1 1/2	10
LCC1/0-56CH-X		5/16	.88	.76	1.44	.12	2.99	Pink	P42	12	42	1 1/2	10
LCC1/0-56DH-X		5/16	1.00	.76	1.44	.12	3.12	Pink	P42	12	42	1 1/2	10
LCC1/0-38DH-X		3/8	1.00	.76	1.44	.12	3.19	Pink	P42	12	42	1 1/2	10
LCC1/0-12DH-X		1/2	1.00	.80	1.44	.12	3.46	Pink	P42	12	42	1 1/2	10
LCC1/0-12H-X	1/2	1.75	.80	1.44	.12	4.36	Pink	P42	12	42	1 1/2	10	
LCC2/0-14AH-X	2/0 AWG	1/4	.63	.85	1.50	.13	2.87	Black	P45	13	45	1 9/16	10
LCC2/0-14BH-X		1/4	.75	.85	1.50	.13	2.99	Black	P45	13	45	1 9/16	10
LCC2/0-56DH-X		5/16	1.00	.85	1.50	.13	3.24	Black	P45	13	45	1 9/16	10
LCC2/0-38DH-X		3/8	1.00	.85	1.50	.13	3.31	Black	P45	13	45	1 9/16	10
LCC2/0-12DH-X		1/2	1.00	.85	1.50	.13	3.56	Black	P45	13	45	1 9/16	10
LCC2/0-12H-X		1/2	1.75	.85	1.50	.13	4.47	Black	P45	13	45	1 9/16	10
LCC3/0-14BH-X	3/0 AWG	1/4	.75	.96	1.50	.13	3.02	Orange	P50	14	50	1 9/16	10
LCC3/0-38DH-X		3/8	1.00	.96	1.50	.13	3.33	Orange	P50	14	50	1 9/16	10
LCC3/0-12DH-X		1/2	1.00	.96	1.50	.13	3.58	Orange	P50	14	50	1 9/16	10
LCC3/0-12H-X		1/2	1.75	.96	1.50	.13	4.50	Orange	P50	14	50	1 9/16	10
LCC4/0-14BH-X	4/0 AWG	1/4	.75	1.06	1.56	.14	3.11	Purple	P54	15	54	1 5/8	10
LCC4/0-56DH-X		5/16	1.00	1.06	1.56	.14	3.37	Purple	P54	15	54	1 5/8	10
LCC4/0-38DH-X		3/8	1.00	1.06	1.56	.14	3.44	Purple	P54	15	54	1 5/8	10
LCC4/0-38H-X		3/8	1.75	1.06	1.56	.14	4.19	Purple	P54	15	54	1 5/8	10
LCC4/0-12DH-X		1/2	1.00	1.06	1.56	.14	3.67	Purple	P54	15	54	1 5/8	10
LCC4/0-12H-X		1/2	1.75	1.06	1.56	.14	4.58	Purple	P54	15	54	1 5/8	10
LCC250-38DH-X	250 kcmil	3/8	1.00	1.17	1.61	.14	3.51	Yellow	P62	16	62	1 11/16	10
LCC250-12DH-X		1/2	1.00	1.17	1.61	.14	3.74	Yellow	P62	16	62	1 11/16	10
LCC250-12H-X		1/2	1.75	1.17	1.61	.14	4.65	Yellow	P62	16	62	1 11/16	10
LCC300-38DH-X	300 kcmil	3/8	1.00	1.19	2.24	.16	4.05	White	P66	17	66	2 5/16	10
LCC300-12H-X		1/2	1.75	1.19	2.24	.16	5.23	White	P66	17	66	2 5/16	10
LCC350-14BH-X	350 kcmil	1/4	.75	1.28	2.24	.17	3.61	Red	P71	18	71	2 5/16	10
LCC350-38DH-X		3/8	1.00	1.28	2.24	.17	4.09	Red	P71	18	71	2 5/16	10
LCC350-12H-X		1/2	1.75	1.28	2.24	.17	5.27	Red	P71	18	71	2 5/16	10
LCC400-14BH-6	400 kcmil	1/4	.75	1.39	2.30	.18	3.70	Blue	P76	19	76	2 3/8	6
LCC400-38DH-6		3/8	1.00	1.39	2.30	.18	4.18	Blue	P76	19	76	2 3/8	6
LCC400-12H-6		1/2	1.75	1.39	2.30	.18	5.36	Blue	P76	19	76	2 3/8	6
LCC500-14BH-6	500 kcmil	1/4	.75	1.54	2.50	.22	3.91	Brown	P87	20	87	2 5/8	6
LCC500-38DH-6		3/8	1.00	1.54	2.50	.22	4.39	Brown	P87	20	87	2 5/8	6
LCC500-12H-6		1/2	1.75	1.54	2.50	.22	5.57	Brown	P87	20	87	2 5/8	6
LCC600-38DH-6	600 kcmil	3/8	1.00	1.70	2.69	.26	4.61	Green	P94	22	94	2 3/4	6
LCC600-12H-6		1/2	1.75	1.70	2.69	.26	5.79	Green	P94	22	94	2 3/4	6

‡See pages L12, L13 and L14, L15 in Technical Info section for tool and die information.

**Consult cable manufacturer for voltage stress relief instructions with applications greater than 2000 volts.

◆NEMA hole sizes and spacing.

System Overview

Terminals

Disconnects

Splices

Ferrules

Compression Connectors

Crimping Tools

Mechanical Connectors

Grounding Connectors

Support Products

Technical Info

Index

System Overview  **Code Conductor, Two-Hole, Long Barrel Lug, 90° Angle**

For Use with Stranded Copper Conductors

Type LCC-F

- Long barrel maximizes number of crimps and provides premium wire pull-out strength and electrical performance
- Color coded barrels marked with **PANDUIT®** and specified competitor die index numbers for proper crimp die selection
- Enclosed barrel prevents corrosive material from entering barrel when used in harsh environments
- Tin plated to inhibit corrosion
- UL Listed for use up to 35KV**, temperature rated 90°C and CSA Certified to 600V when crimped with **PANDUIT®** and specified competitor crimping tools and dies
- UL Listed and CSA Certified for wire range-taking capability when crimped with **PANDUIT® UNI-DIE™** dieless crimping tools‡
- **Tested by Telcordia — meets NEBS Level 3**
- Available with NEMA hole sizes and spacing

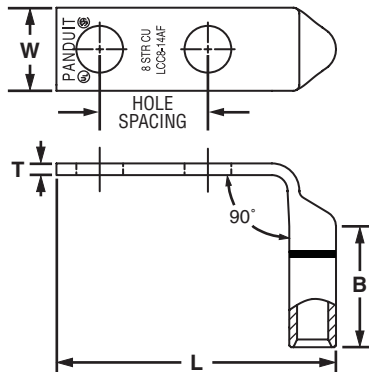

Part Number	Copper Conductor Size	Stud Hole Size (In.)	Stud Hole Spacing (In.)	Figure Dimensions (In.)				PANDUIT® Color Code	PANDUIT® Die Index No.‡	Burdny Die Index No.‡	T&B Die Index No.‡	Wire Strip Length (In.)	Std. Pkg. Qty.
				W	B	T	L						
LCC8-10AF-L	#8 AWG	#10	.63	.41	.70	.08	1.53	Red	P21	49	21	3/4	50
LCC8-14BF-L		1/4	.75	.48	.70	.07	1.74	Red	P21	49	21	3/4	50
LCC8-14AF-L		1/4	.63	.48	.70	.07	1.62	Red	P21	49	21	3/4	50
LCC8-14DF-L		1/4	1.00	.48	.70	.07	1.99	Red	P21	49	21	3/4	50
LCC8-38DF-L		3/8	1.00	.60	.70	.05	2.21	Red	P21	49	21	3/4	50
LCC6-10AF-L	#6 AWG	#10	.63	.46	1.07	.08	1.57	Blue	P24	7	24	1 1/8	50
LCC6-14AF-L		1/4	.63	.48	1.07	.08	1.66	Blue	P24	7	24	1 1/8	50
LCC6-14BF-L		1/4	.75	.48	1.07	.08	1.78	Blue	P24	7	24	1 1/8	50
LCC6-14DF-L		1/4	1.00	.48	1.07	.08	2.03	Blue	P24	7	24	1 1/8	50
LCC6-38DF-L		3/8	1.00	.62	1.07	.05	2.25	Blue	P24	7	24	1 1/8	50
LCC4-14AF-L	#4 – #3 AWG STR, #2 AWG SOL	1/4	.63	.55	1.05	.09	1.74	Gray	P29	8	29	1 1/8	50
LCC4-14BF-L		1/4	.75	.55	1.05	.09	1.87	Gray	P29	8	29	1 1/8	50
LCC4-38DF-L		3/8	1.00	.62	1.05	.08	2.34	Gray	P29	8	29	1 1/8	50
LCC2-14AF-Q	#2 AWG	1/4	.63	.60	1.16	.10	1.86	Brown	P33	10	33	1 1/4	25
LCC2-14BF-Q		1/4	.75	.60	1.16	.10	1.99	Brown	P33	10	33	1 1/4	25
LCC2-56BF-Q		5/16	.75	.66	1.16	.10	2.11	Brown	P33	10	33	1 1/4	25
LCC2-56CF-Q		5/16	.88	.66	1.16	.10	2.24	Brown	P33	10	33	1 1/4	25
LCC2-38DF-Q		3/8	1.00	.66	1.16	.10	2.44	Brown	P33	10	33	1 1/4	25
LCC2-38F-Q		3/8	1.75	.66	1.16	.10	3.19	Brown	P33	10	33	1 1/4	25
LCC2-12F-Q		1/2	1.75	.75	1.16	.08	3.61	Brown	P33	10	33	1 1/4	25

PANDUIT® TERMINATION SOLUTIONS



Code Conductor, Two-Hole, Long Barrel Lug, 90° Angle (continued)

Part Number	Copper Conductor Size	Stud Hole Size (In.)	Stud Hole Spacing (In.)	Figure Dimensions (In.)				PANDUIT® Color Code	PANDUIT® Die Index No.‡	Burndy Die Index No.‡	T&B Die Index No.‡	Wire Strip Length (In.)	Std. Pkg. Qty.
				W	B	T	L						
LCC1-14AF-E	#1 AWG	1/4	.63	.70	1.36	.11	1.94	Green	P37	11	37	1 7/16	20
LCC1-14BF-E		1/4	.75	.70	1.36	.11	2.06	Green	P37	11	37	1 7/16	20
LCC1-56BF-E		5/16	.75	.70	1.36	.11	2.19	Green	P37	11	37	1 7/16	20
LCC1-56CF-E		5/16	.88	.70	1.36	.11	2.31	Green	P37	11	37	1 7/16	20
LCC1-38DF-E		3/8	1.00	.70	1.36	.11	2.51	Green	P37	11	37	1 7/16	20
LCC1-12F-E		1/2	1.75	.75	1.36	.09	3.68	Green	P37	11	37	1 7/16	20
LCC1/0-14AF-X	1/0 AWG	1/4	.63	.76	1.44	.12	2.08	Pink	P42	12	42	1 1/2	10
LCC1/0-14BF-X		1/4	.75	.76	1.44	.12	2.20	Pink	P42	12	42	1 1/2	10
LCC1/0-56CF-X		5/16	.88	.76	1.44	.12	2.38	Pink	P42	12	42	1 1/2	10
LCC1/0-56DF-X		5/16	1.00	.76	1.44	.12	2.51	Pink	P42	12	42	1 1/2	10
LCC1/0-38DF-X		3/8	1.00	.76	1.44	.12	2.58	Pink	P42	12	42	1 1/2	10
LCC1/0-12DF-X		1/2	1.00	.80	1.44	.12	2.85	Pink	P42	12	42	1 1/2	10
LCC1/0-12F-X	1/2	1.75	.80	1.44	.12	3.75	Pink	P42	12	42	1 1/2	10	
LCC2/0-14AF-X	2/0 AWG	1/4	.63	.85	1.50	.13	2.22	Black	P45	13	45	1 9/16	10
LCC2/0-14BF-X		1/4	.75	.85	1.50	.13	2.34	Black	P45	13	45	1 9/16	10
LCC2/0-56DF-X		5/16	1.00	.85	1.50	.13	2.59	Black	P45	13	45	1 9/16	10
LCC2/0-38DF-X		3/8	1.00	.85	1.50	.13	2.66	Black	P45	13	45	1 9/16	10
LCC2/0-12DF-X		1/2	1.00	.85	1.50	.13	2.85	Black	P45	13	45	1 9/16	10
LCC2/0-12F-X		1/2	1.75	.85	1.50	.13	3.82	Black	P45	13	45	1 9/16	10
LCC3/0-14BF-X	3/0 AWG	1/4	.75	.96	1.50	.13	2.42	Orange	P50	14	50	1 9/16	10
LCC3/0-38DF-X		3/8	1.00	.96	1.50	.13	2.73	Orange	P50	14	50	1 9/16	10
LCC3/0-12DF-X		1/2	1.00	.96	1.50	.13	2.98	Orange	P50	14	50	1 9/16	10
LCC3/0-12F-X		1/2	1.75	.96	1.50	.13	3.89	Orange	P50	14	50	1 9/16	10
LCC4/0-14BF-X	4/0 AWG	1/4	.75	1.06	1.56	.14	2.50	Purple	P54	15	54	1 5/8	10
LCC4/0-56DF-X		5/16	1.00	1.06	1.56	.14	2.77	Purple	P54	15	54	1 5/8	10
LCC4/0-38DF-X		3/8	1.00	1.06	1.56	.14	2.84	Purple	P54	15	54	1 5/8	10
LCC4/0-38F-X		3/8	1.75	1.06	1.56	.14	3.59	Purple	P54	15	54	1 5/8	10
LCC4/0-12DF-X		1/2	1.00	1.06	1.56	.14	3.07	Purple	P54	15	54	1 5/8	10
◆ LCC4/0-12F-X	1/2	1.75	1.06	1.56	.14	3.98	Purple	P54	15	54	1 5/8	10	
LCC250-38DF-X	250 kcmil	3/8	1.00	1.17	1.61	.14	2.90	Yellow	P62	16	62	1 11/16	10
LCC250-12DF-X		1/2	1.00	1.17	1.61	.14	3.13	Yellow	P62	16	62	1 11/16	10
◆ LCC250-12F-X	1/2	1.75	1.17	1.61	.14	4.04	Yellow	P62	16	62	1 11/16	10	
LCC300-38DF-X	300 kcmil	3/8	1.00	1.19	2.24	.16	2.88	White	P66	17	66	2 5/16	10
◆ LCC300-12F-X		1/2	1.75	1.19	2.24	.16	4.06	White	P66	17	66	2 5/16	10
LCC350-14BF-X	350 kcmil	1/4	.75	1.28	2.24	.17	2.46	Red	P71	18	71	2 5/16	10
LCC350-38DF-X		3/8	1.00	1.28	2.24	.17	2.94	Red	P71	18	71	2 5/16	10
◆ LCC350-12F-X		1/2	1.75	1.28	2.24	.17	4.12	Red	P71	18	71	2 5/16	10
LCC400-14BF-6	400 kcmil	1/4	.75	1.39	2.30	.18	2.54	Blue	P76	19	76	2 3/8	6
LCC400-38DF-6		3/8	1.00	1.39	2.30	.18	3.02	Blue	P76	19	76	2 3/8	6
◆ LCC400-12F-6		1/2	1.75	1.39	2.30	.18	4.20	Blue	P76	19	76	2 3/8	6
LCC500-14BF-6	500 kcmil	1/4	.75	1.54	2.50	.22	2.65	Brown	P87	20	87	2 9/16	6
LCC500-38DF-6		3/8	1.00	1.54	2.50	.22	3.13	Brown	P87	20	87	2 9/16	6
◆ LCC500-12F-6		1/2	1.75	1.54	2.50	.22	4.31	Brown	P87	20	87	2 9/16	6
LCC600-38DF-6	600 kcmil	3/8	1.00	1.70	2.69	.26	3.26	Green	P94	22	94	2 3/4	6
◆ LCC600-12F-6		1/2	1.75	1.70	2.69	.26	4.44	Green	P94	22	94	2 3/4	6

‡See pages L12, L13 and L14, L15 in Technical Info section for tool and die information.

**Consult cable manufacturer for voltage stress relief instructions with applications greater than 2000 volts.

◆NEMA hole sizes and spacing.

System Overview

Terminals

Disconnects

Splices

Ferrules

Compression Connectors

Crimping Tools

Mechanical Connectors

Grounding Connectors

Support Products

Technical Info

Index

PANDUIT® TERMINATION SOLUTIONS

System Overview

NEW!



Code Conductor, Two-Hole, Long Barrel with Window Lug

For Use with Stranded Copper Conductors

Type LCC-W

- Long barrel maximizes number of crimps and provides premium wire pull-out strength and electrical performance
- Inspection window to visually assure full conductor insertion
- Color coded barrels marked with **PANDUIT®** and specified competitor die index numbers for proper crimp die selection
- Tin plated to inhibit corrosion
- UL Listed for use up to 35KV**, temperature rated 90°C and CSA Certified to 600V when crimped with **PANDUIT®** and specified competitor crimping tools and dies
- UL Listed and CSA Certified for wire range-taking capability when crimped with **PANDUIT® UNI-DIE™** dieless crimping tools‡
- **Tested by Telcordia — meets NEBS Level 3**
- Meets TIA-607 requirements for network systems grounding applications
- Available with NEMA hole sizes and spacing

Terminals

Disconnects

Splices

Ferrules

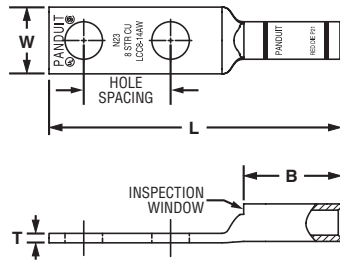

Figure 1

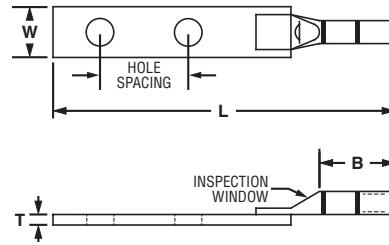

Figure 2: Two Piece Brazed Tongue Construction

Compression Connectors

Crimping Tools

Mechanical Connectors

Grounding Connectors

Support Products

Technical Info

Index

Part Number	Figure No.	Copper Conductor Size	Stud Hole Size (In.)	Stud Hole Spacing (In.)	Figure Dimensions (In.)				PANDUIT® Color Code	PANDUIT® Die Index No.‡	Burndy Die Index No.‡	T&B Die Index No.‡	Wire Strip Length (In.)	Std. Pkg. Qty.
					W	B	T	L						
LCC10-14AW-L*	1	#14 – #10 AWG STR	1/4	.63	.42	.53	.05	1.93	—	—	—	—	9/16	50
LCC10-14BW-L*	1	#12 – #10 AWG SOL	1/4	.75	.42	.53	.05	2.06	—	—	—	—	9/16	50
LCC8-10AW-L	1	#8 AWG	#10	.63	.41	.70	.08	2.01	Red	P21	49	21	3/4	50
LCC8-10BW-L	1		#10	.75	.41	.70	.08	2.14	Red	P21	49	21	3/4	50
LCC8-14AW-L	1		1/4	.63	.48	.70	.07	2.10	Red	P21	49	21	3/4	50
LCC8-14BW-L	1		1/4	.75	.48	.70	.07	2.23	Red	P21	49	21	3/4	50
LCC8-14DW-L	1		1/4	1.00	.48	.70	.07	2.48	Red	P21	49	21	3/4	50
LCC8-38DW-L	1		3/8	1.00	.60	.70	.05	2.70	Red	P21	49	21	3/4	50
LCC6-10AW-L	1	#6 AWG	#10	.63	.46	1.07	.08	2.40	Blue	P24	7	24	1 1/8	50
LCC6-10BW-L	1		#10	.75	.46	1.07	.08	2.52	Blue	P24	7	24	1 1/8	50
LCC6-14JW-L	1		1/4	.50	.48	1.07	.08	2.36	Blue	P24	7	24	1 1/8	50
LCC6-14AW-L	1		1/4	.63	.48	1.07	.08	2.49	Blue	P24	7	24	1 1/8	50
LCC6-14BW-L	1		1/4	.75	.48	1.07	.08	2.61	Blue	P24	7	24	1 1/8	50
LCC6-14DW-L	1		1/4	1.00	.48	1.07	.08	2.86	Blue	P24	7	24	1 1/8	50
LCC6-14EW-L	1		1/4	1.25	.48	1.07	.08	3.11	Blue	P24	7	24	1 1/8	50
LCC6-14W-L	1		1/4	1.75	.48	1.07	.08	3.61	Blue	P24	7	24	1 1/8	50
LCC6-56BW-L	1		5/16	.75	.56	1.07	.07	2.73	Blue	P24	7	24	1 1/8	50
LCC6-38BW-L	1		3/8	.75	.62	1.07	.06	2.83	Blue	P24	7	24	1 1/8	50
LCC6-38CW-L	1	3/8	.88	.62	1.07	.06	2.96	Blue	P24	7	24	1 1/8	50	
LCC6-38DW-L	1	3/8	1.00	.62	1.07	.06	3.08	Blue	P24	7	24	1 1/8	50	
LCC6-12W-L	2		1/2	1.75	.75	1.13	.16	5.00	Blue	P24	7	24	1 3/16	50
LCC4-10AW-L	1	#4 – #3 AWG STR, #2 AWG SOL	#10	.63	.55	1.05	.09	2.40	Gray	P29	8	29	1 1/8	50
LCC4-10BW-L	1		#10	.75	.55	1.05	.09	2.53	Gray	P29	8	29	1 1/8	50
LCC4-14AW-L	1		1/4	.63	.55	1.05	.09	2.50	Gray	P29	8	29	1 1/8	50
LCC4-14BW-L	1		1/4	.75	.55	1.05	.09	2.63	Gray	P29	8	29	1 1/8	50
LCC4-14DW-L	1		1/4	1.00	.55	1.05	.09	2.63	Gray	P29	8	29	1 1/8	50
LCC4-38DW-L	1		3/8	1.00	.62	1.05	.08	3.09	Gray	P29	8	29	1 1/8	50
LCC4-12W-L	2		1/2	1.75	.75	1.13	.16	5.06	Gray	P29	8	29	1 3/16	50

PANDUIT® TERMINATION SOLUTIONS



Code Conductor, Two-Hole, Long Barrel with Window Lug (continued)

Part Number	Figure No.	Copper Conductor Size	Stud Hole Size (In.)	Stud Hole Spacing (In.)	Figure Dimensions (In.)				PANDUIT® Color Code	PANDUIT® Die Index No.‡	Burndy Die Index No.‡	T&B Die Index No.‡	Wire Strip Length (In.)	Std. Pkg. Qty.
					W	B	T	L						
LCC2-10AW-Q	1	#2 AWG	#10	.63	.60	1.16	.10	2.57	Brown	P33	10	33	1 1/4	25
LCC2-10BW-Q	1		#10	.75	.60	1.16	.10	2.69	Brown	P33	10	33	1 1/4	25
LCC2-14AW-Q	1		1/4	.63	.60	1.16	.10	2.67	Brown	P33	10	33	1 1/4	25
LCC2-14BW-Q	1		1/4	.75	.60	1.16	.10	2.79	Brown	P33	10	33	1 1/4	25
LCC2-14DW-Q	1		1/4	1.00	.60	1.16	.10	3.04	Brown	P33	10	33	1 1/4	25
LCC2-56BW-Q	1		5/16	.75	.66	1.16	.10	2.92	Brown	P33	10	33	1 1/4	25
LCC2-56CW-Q	1		5/16	.88	.66	1.16	.10	3.04	Brown	P33	10	33	1 1/4	25
LCC2-38BW-Q	1		3/8	.75	.66	1.16	.10	2.99	Brown	P33	10	33	1 1/4	25
LCC2-38CW-Q	1		3/8	.88	.66	1.16	.10	3.12	Brown	P33	10	33	1 1/4	25
LCC2-38DW-Q	1		3/8	1.00	.66	1.16	.10	3.24	Brown	P33	10	33	1 1/4	25
LCC2-38W-Q	1		3/8	1.75	.66	1.16	.10	3.99	Brown	P33	10	33	1 1/4	25
LCC2-12W-Q	1		1/2	1.75	.75	1.16	.08	4.41	Brown	P33	10	33	1 1/4	25
LCC1-14AW-E	1		#1 AWG	1/4	.63	.70	1.36	.11	2.89	Green	P37	11	37	1 7/16
LCC1-14BW-E	1	1/4		.75	.70	1.36	.11	3.01	Green	P37	11	37	1 7/16	20
LCC1-56BW-E	1	5/16		.75	.70	1.36	.11	3.14	Green	P37	11	37	1 7/16	20
LCC1-56CW-E	1	5/16		.88	.70	1.36	.11	3.26	Green	P37	11	37	1 7/16	20
LCC1-38DW-E	1	3/8		1.00	.70	1.36	.11	3.46	Green	P37	11	37	1 7/16	20
LCC1-12W-E	1	1/2		1.75	.75	1.36	.09	4.63	Green	P37	11	37	1 7/16	20
LCC1/0-14AW-X	1	1/0 AWG		1/4	.63	.76	1.44	.12	3.07	Pink	P42	12	42	1 1/2
LCC1/0-14BW-X	1		1/4	.75	.76	1.44	.12	3.19	Pink	P42	12	42	1 1/2	10
LCC1/0-14DW-X	1		1/4	1.00	.76	1.44	.12	3.44	Pink	P42	12	42	1 1/2	10
LCC1/0-38DW-X	1		3/8	1.00	.76	1.44	.12	3.57	Pink	P42	12	42	1 1/2	10
LCC1/0-38W-X	1		3/8	1.75	.76	1.44	.12	4.32	Pink	P42	12	42	1 1/2	10
LCC1/0-12DW-X	1		1/2	1.00	.80	1.44	.12	3.84	Pink	P42	12	42	1 1/2	10
LCC1/0-12W-X	1		1/2	1.75	.80	1.44	.12	4.74	Pink	P42	12	42	1 1/2	10
LCC2/0-14AW-X	1	2/0 AWG	1/4	.63	.85	1.50	.13	3.23	Black	P45	13	45	1 9/16	10
LCC2/0-14BW-X	1		1/4	.75	.85	1.50	.13	3.36	Black	P45	13	45	1 9/16	10
LCC2/0-56DW-X	1		5/16	1.00	.85	1.50	.13	3.61	Black	P45	13	45	1 9/16	10
LCC2/0-38DW-X	1		3/8	1.00	.85	1.50	.13	3.67	Black	P45	13	45	1 9/16	10
LCC2/0-12DW-X	1		1/2	1.00	.85	1.50	.13	3.92	Black	P45	13	45	1 9/16	10
LCC2/0-12W-X	1	1/2	1.75	.85	1.50	.13	4.83	Black	P45	13	45	1 9/16	10	
LCC3/0-14BW-X	1	3/0 AWG	1/4	.75	.96	1.50	.13	3.39	Orange	P50	14	50	1 9/16	10
LCC3/0-56DW-X	1		5/16	1.00	.96	1.50	.13	3.64	Orange	P50	14	50	1 9/16	10
LCC3/0-38DW-X	1		3/8	1.00	.96	1.50	.13	3.70	Orange	P50	14	50	1 9/16	10
LCC3/0-12DW-X	1		1/2	1.00	.96	1.50	.13	3.95	Orange	P50	14	50	1 9/16	10
LCC3/0-12W-X	1		1/2	1.75	.96	1.50	.13	4.87	Orange	P50	14	50	1 9/16	10
LCC4/0-14AW-X	1	4/0 AWG	1/4	.63	1.06	1.56	.14	3.35	Purple	P54	15	54	1 5/8	10
LCC4/0-14BW-X	1		1/4	.75	1.06	1.56	.14	3.48	Purple	P54	15	54	1 5/8	10
LCC4/0-56DW-X	1		5/16	1.00	1.06	1.56	.14	3.74	Purple	P54	15	54	1 5/8	10
LCC4/0-38DW-X	1		3/8	1.00	1.06	1.56	.14	3.81	Purple	P54	15	54	1 5/8	10
LCC4/0-38W-X	1		3/8	1.75	1.06	1.56	.14	4.56	Purple	P54	15	54	1 5/8	10
LCC4/0-12DW-X	1		1/2	1.00	1.06	1.56	.14	4.04	Purple	P54	15	54	1 5/8	10
LCC4/0-12W-X	1		1/2	1.75	1.06	1.56	.14	4.95	Purple	P54	15	54	1 5/8	10
LCC250-56DW-X	1	250 kcmil	5/16	1.00	1.17	1.61	.14	3.82	Yellow	P62	16	62	1 11/16	10
LCC250-38DW-X	1		3/8	1.00	1.17	1.61	.14	3.89	Yellow	P62	16	62	1 11/16	10
LCC250-12DW-X	1		1/2	1.00	1.17	1.61	.14	4.12	Yellow	P62	16	62	1 11/16	10
LCC250-12W-X	1	300 kcmil	1/2	1.75	1.17	1.61	.14	5.03	Yellow	P62	16	62	1 11/16	10
LCC300-38DW-X	1		3/8	1.00	1.19	2.24	.16	4.54	White	P66	17	66	2 5/16	10
LCC300-12W-X	1		1/2	1.75	1.19	2.24	.16	5.72	White	P66	17	66	2 5/16	10

Chart continues on page F48

System Overview

Terminals

Disconnects

Splices

Ferrules

Compression Connectors

Crimping Tools

Mechanical Connectors

Grounding Connectors

Support Products

Technical Info

Index

System Overview



Code Conductor, Two-Hole, Long Barrel with Window Lug (continued)

Terminals

Disconnects

Splices

Ferrules

Compression Connectors

Crimping Tools

Mechanical Connectors

Grounding Connectors

Support Products

Technical Info

Index

Part Number	Figure No.	Copper Conductor Size	Stud Hole Size (In.)	Stud Hole Spacing (In.)	Figure Dimensions (In.)				PANDUIT® Color Code	PANDUIT® Die Index No.‡	Burndy Die Index No.‡	T&B Die Index No.‡	Wire Strip Length (In.)	Std. Pkg. Qty.
					W	B	T	L						
LCC350-14BW-X	1	350 kcmil	1/4	.75	1.28	2.24	.17	4.10	Red	P71	18	71	2 5/16	10
LCC350-38DW-X	1		3/8	1.00	1.28	2.24	.17	4.58	Red	P71	18	71	2 5/16	10
LCC350-12W-X	1		1/2	1.75	1.28	2.24	.17	5.76	Red	P71	18	71	2 5/16	10
LCC400-14BW-6	1	400 kcmil	1/4	.75	1.39	2.30	.18	4.18	Blue	P76	19	76	2 3/8	6
LCC400-38DW-6	1		3/8	1.00	1.39	2.30	.18	4.66	Blue	P76	19	76	2 3/8	6
LCC400-12W-6	1		1/2	1.75	1.28	2.30	.17	5.84	Blue	P76	19	76	2 3/8	6
LCC500-14BW-6	1	500 kcmil	1/4	.75	1.54	2.50	.22	4.46	Brown	P87	20	87	2 9/16	6
LCC500-38DW-6	1		3/8	1.00	1.54	2.50	.22	4.94	Brown	P87	20	87	2 9/16	6
LCC500-12W-6	1		1/2	1.75	1.54	2.50	.22	6.12	Brown	P87	20	87	2 9/16	6
LCC600-38DW-6	1	600 kcmil	3/8	1.00	1.70	2.69	.26	5.18	Green	P94	22	94	2 3/4	6
LCC600-12W-6	1		1/2	1.75	1.70	2.69	.26	6.36	Green	P94	22	94	2 3/4	6
LCC750-38DW-6	1	750 kcmil	3/8	1.00	1.89	2.88	.26	5.71	Black	P106	24	106	2 15/16	6
LCC750-12W-6	1		1/2	1.75	1.89	2.88	.26	6.65	Black	P106	24	106	2 15/16	6
LCC800-12W-6	1	800 kcmil	1/2	1.75	1.95	2.94	.30	6.74	Orange	P107	25	107	3	6
LCC1000-38DW-3	1	1000 kcmil	3/8	1.00	2.17	3.00	.32	5.95	White	P125	27	125	3 1/16	3
LCC1000-12W-3	1		1/2	1.75	2.17	3.00	.32	6.89	White	P125	27	125	3 1/16	3

‡See [pages L12, L13 and L14, L15](#) in Technical Info section for tool and die information.

*Not tested to NEBS Level 3 requirements.

**Consult cable manufacturer for voltage stress relief instructions with applications greater than 2000 volts.

◆NEMA hole sizes and spacing.

NEW!



Code Conductor, Two-Hole, Long Barrel with Window Lug, 45° Angle

For Use with Stranded Copper Conductors

Type LCC-WH

- Long barrel maximizes number of crimps and provides premium wire pull-out strength and electrical performance
- Inspection window to visually assure full conductor insertion
- Color coded barrels marked with **PANDUIT®** and specified competitor die index numbers for proper crimp die selection
- Tin plated to inhibit corrosion
- UL Listed for use up to 35KV**, temperature rated 90°C and CSA Certified to 600V when crimped with **PANDUIT®** and specified competitor crimping tools and dies
- UL Listed and CSA Certified for wire range-taking capability when crimped with **PANDUIT® UNI-DIE™** dieless crimping tools‡
- **Tested by Telcordia — meets NEBS Level 3**
- Meets TIA-607 requirements for network systems grounding applications
- Available with NEMA hole sizes and spacing

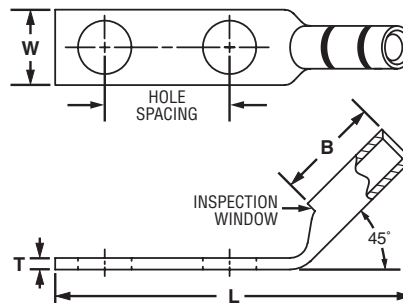

Part Number	Copper Conductor Size	Stud Hole Size (In.)	Stud Hole Spacing (In.)	Figure Dimensions (In.)				PANDUIT® Color Code	PANDUIT® Die Index No.‡	Burndy Die Index No.‡	T&B Die Index No.‡	Wire Strip Length (In.)	Std. Pkg. Qty.
				W	B	T	L						
LCC10-14AWH-L*	#14 – #10 AWG STR #12 – #10 AWG SOL	1/4	.63	.42	.53	.05	1.78	—	—	—	—	9/16	50
LCC10-14BWH-L*		1/4	.75	.42	.53	.05	1.90	—	—	—	—	9/16	50
LCC8-10AWH-L	#8 AWG	#10	.63	.41	.70	.08	1.82	Red	P21	49	21	3/4	50
LCC8-10BWH-L		#10	.75	.41	.70	.08	1.95	Red	P21	49	21	3/4	50
LCC8-14AWH-L		1/4	.63	.48	.70	.07	1.91	Red	P21	49	21	3/4	50
LCC8-14BWH-L		1/4	.75	.48	.70	.07	2.03	Red	P21	49	21	3/4	50
LCC8-14DWH-L		1/4	1.00	.48	.70	.07	2.28	Red	P21	49	21	3/4	50
LCC8-38DWH-L		3/8	1.00	.60	.70	.05	2.49	Red	P21	49	21	3/4	50
LCC6-10AWH-L	#6 AWG	#10	.63	.46	1.07	.08	2.09	Blue	P24	7	24	1 1/8	50
LCC6-10BWH-L		#10	.75	.46	1.07	.08	2.22	Blue	P24	7	24	1 1/8	50
LCC6-14JWH-L		1/4	.50	.48	1.07	.08	2.06	Blue	P24	7	24	1 1/8	50
LCC6-14AWH-L		1/4	.63	.48	1.07	.08	2.18	Blue	P24	7	24	1 1/8	50
LCC6-14BWH-L		1/4	.75	.48	1.07	.08	2.31	Blue	P24	7	24	1 1/8	50
LCC6-14DWH-L		1/4	1.00	.48	1.07	.08	2.56	Blue	P24	7	24	1 1/8	50
LCC6-14EWH-L		1/4	1.25	.48	1.07	.08	2.81	Blue	P24	7	24	1 1/8	50
LCC6-56BWH-L		5/16	.75	.56	1.07	.07	2.42	Blue	P24	7	24	1 1/8	50
LCC6-38BWH-L		3/8	.75	.62	1.07	.06	2.52	Blue	P24	7	24	1 1/8	50
LCC6-38CWH-L		3/8	.88	.62	1.07	.06	2.64	Blue	P24	7	24	1 1/8	50
LCC6-38DWH-L	3/8	1.00	.62	1.07	.06	2.77	Blue	P24	7	24	1 1/8	50	

Chart continues on page F50

PANDUIT® TERMINATION SOLUTIONS

System Overview



Code Conductor, Two-Hole, Long Barrel with Window Lug, 45° Angle (continued)

Terminals

Disconnects

Splices

Ferrules

Compression Connectors

Crimping Tools

Mechanical Connectors

Grounding Connectors

Support Products

Technical Info

Index

Part Number	Copper Conductor Size	Stud Hole Size (In.)	Stud Hole Spacing (In.)	Figure Dimensions (In.)				PANDUIT® Color Code	PANDUIT® Die Index No.‡	Burndy Die Index No.‡	T&B Die Index No.‡	Wire Strip Length (In.)	Std. Pkg. Qty.	
				W	B	T	L							
LCC4-10AWH-L	#4 – #3 AWG STR, #2 AWG SOL	#10	.63	.55	1.05	.09	2.11	Gray	P29	8	29	1 1/8	50	
LCC4-10BWH-L		#10	.75	.55	1.05	.09	2.23	Gray	P29	8	29	1 1/8	50	
LCC4-14AWH-L		1/4	.63	.55	1.05	.09	2.20	Gray	P29	8	29	1 1/8	50	
LCC4-14BWH-L		1/4	.75	.55	1.05	.09	2.32	Gray	P29	8	29	1 1/8	50	
LCC4-38DWH-L		3/8	1.00	.62	1.05	.08	2.79	Gray	P29	8	29	1 1/8	50	
LCC2-10AWH-Q	#2 AWG	#10	.63	.60	1.16	.10	2.21	Brown	P33	10	33	1 1/4	25	
LCC2-10BWH-Q		#10	.75	.60	1.16	.10	2.33	Brown	P33	10	33	1 1/4	25	
LCC2-14AWH-Q		1/4	.63	.60	1.16	.10	2.31	Brown	P33	10	33	1 1/4	25	
LCC2-14BWH-Q		1/4	.75	.60	1.16	.10	2.43	Brown	P33	10	33	1 1/4	25	
LCC2-14DWH-Q		1/4	1.00	.60	1.16	.10	2.68	Brown	P33	10	33	1 1/4	25	
LCC2-56BWH-Q	#2 AWG	5/16	.75	.66	1.16	.10	2.55	Brown	P33	10	33	1 1/4	25	
LCC2-56CWH-Q		5/16	.88	.66	1.16	.10	2.68	Brown	P33	10	33	1 1/4	25	
LCC2-38BWH-Q		3/8	.75	.66	1.16	.10	2.63	Brown	P33	10	33	1 1/4	25	
LCC2-38CWH-Q		3/8	.88	.66	1.16	.10	2.75	Brown	P33	10	33	1 1/4	25	
LCC2-38DWH-Q		3/8	1.00	.66	1.16	.10	2.88	Brown	P33	10	33	1 1/4	25	
LCC2-38WH-Q	#1 AWG	3/8	1.75	.66	1.16	.10	3.63	Brown	P33	10	33	1 1/4	25	
LCC2-12WH-Q		1/2	1.75	.75	1.16	.08	4.03	Brown	P33	10	33	1 1/4	25	
LCC1-14AWH-E		1/4	.63	.70	1.36	.11	2.46	Green	P37	11	37	1 7/16	20	
LCC1-14BWH-E		1/4	.75	.70	1.36	.11	2.58	Green	P37	11	37	1 7/16	20	
LCC1-56BWH-E		5/16	.75	.70	1.36	.11	2.71	Green	P37	11	37	1 7/16	20	
LCC1-56CWH-E	#1 AWG	5/16	.88	.70	1.36	.11	2.83	Green	P37	11	37	1 7/16	20	
LCC1-38DWH-E		3/8	1.00	.70	1.36	.11	3.04	Green	P37	11	37	1 7/16	20	
LCC1-12WH-E		1/2	1.75	.75	1.36	.09	4.20	Green	P37	11	37	1 7/16	20	
LCC1/0-14AWH-X		1/0 AWG	1/4	.63	.76	1.44	.12	2.61	Pink	P42	12	42	1 1/2	10
LCC1/0-14BWH-X			1/4	.75	.76	1.44	.12	2.73	Pink	P42	12	42	1 1/2	10
LCC1/0-14DWH-X	1/4		1.00	.76	1.44	.12	2.98	Pink	P42	12	42	1 1/2	10	
LCC1/0-38DWH-X	3/8		1.00	.76	1.44	.12	3.11	Pink	P42	12	42	1 1/2	10	
LCC1/0-38WH-X	3/8		1.75	.76	1.44	.12	3.86	Pink	P42	12	42	1 1/2	10	
LCC1/0-12DWH-X	2/0 AWG	1/2	1.00	.80	1.44	.12	3.37	Pink	P42	12	42	1 1/2	10	
LCC1/0-12WH-X		1/2	1.75	.80	1.44	.12	4.28	Pink	P42	12	42	1 1/2	10	
LCC2/0-14AWH-X		1/4	.63	.85	1.50	.13	2.76	Black	P45	13	45	1 9/16	10	
LCC2/0-14BWH-X		1/4	.75	.85	1.50	.13	2.88	Black	P45	13	45	1 9/16	10	
LCC2/0-56DWH-X		5/16	1.00	.85	1.50	.13	3.13	Black	P45	13	45	1 9/16	10	
LCC2/0-38DWH-X	3/0 AWG	3/8	1.00	.85	1.50	.13	3.20	Black	P45	13	45	1 9/16	10	
LCC2/0-12DWH-X		1/2	1.00	.85	1.50	.13	3.45	Black	P45	13	45	1 9/16	10	
LCC2/0-12WH-X		1/2	1.75	.85	1.50	.13	4.36	Black	P45	13	45	1 9/16	10	
LCC3/0-14BWH-X		1/4	.75	.96	1.50	.13	2.91	Orange	P50	14	50	1 9/16	10	
LCC3/0-56DWH-X		5/16	1.00	.96	1.50	.13	3.16	Orange	P50	14	50	1 9/16	10	
LCC3/0-38DWH-X	4/0 AWG	3/8	1.00	.96	1.50	.13	3.22	Orange	P50	14	50	1 9/16	10	
LCC3/0-12DWH-X		1/2	1.00	.96	1.50	.13	3.47	Orange	P50	14	50	1 9/16	10	
LCC3/0-12WH-X		1/2	1.75	.96	1.50	.13	4.38	Orange	P50	14	50	1 9/16	10	
LCC4/0-14AWH-X		1/4	.63	1.06	1.56	.14	2.85	Purple	P54	15	54	1 5/8	10	
LCC4/0-14BWH-X		1/4	.75	1.06	1.56	.14	2.98	Purple	P54	15	54	1 5/8	10	
LCC4/0-56DWH-X	4/0 AWG	5/16	1.00	1.06	1.56	.14	3.24	Purple	P54	15	54	1 5/8	10	
LCC4/0-38DWH-X		3/8	1.00	1.06	1.56	.14	3.31	Purple	P54	15	54	1 5/8	10	
LCC4/0-38WH-X		3/8	1.75	1.06	1.56	.14	4.06	Purple	P54	15	54	1 5/8	10	
LCC4/0-12DWH-X		1/2	1.00	1.06	1.56	.14	3.54	Purple	P54	15	54	1 5/8	10	
LCC4/0-12WH-X		1/2	1.75	1.06	1.56	.14	4.45	Purple	P54	15	54	1 5/8	10	



Code Conductor, Two-Hole, Long Barrel with Window Lug, 45° Angle (continued)

Part Number	Copper Conductor Size	Stud Hole Size (In.)	Stud Hole Spacing (In.)	Figure Dimensions (In.)				PANDUIT® Color Code	PANDUIT® Die Index No.‡	Burdby Die Index No.‡	T&B Die Index No.‡	Wire Strip Length (In.)	Std. Pkg. Qty.
				W	B	T	L						
LCC250-56DWH-X	250 kcmil	5/16	1.00	1.17	1.61	.14	3.31	Yellow	P62	16	62	1 11/16	10
LCC250-38DWH-X		3/8	1.00	1.17	1.61	.14	3.38	Yellow	P62	16	62	1 11/16	10
LCC250-12DWH-X		1/2	1.00	1.17	1.61	.14	3.61	Yellow	P62	16	62	1 11/16	10
◆ LCC250-12WH-X	300 kcmil	1/2	1.75	1.17	1.61	.14	4.52	Yellow	P62	16	62	1 11/16	10
LCC300-38DWH-X		3/8	1.00	1.19	2.24	.16	3.93	White	P66	17	66	2 5/16	10
◆ LCC300-12WH-X		1/2	1.75	1.19	2.24	.16	5.11	White	P66	17	66	2 5/16	10
LCC350-14BWH-X	350 kcmil	1/4	.75	1.28	2.24	.17	3.48	Red	P71	18	71	2 5/16	10
LCC350-38DWH-X		3/8	1.00	1.28	2.24	.17	3.96	Red	P71	18	71	2 5/16	10
◆ LCC350-12WH-X		1/2	1.75	1.28	2.24	.17	5.14	Red	P71	18	71	2 5/16	10
LCC400-14BWH-6	400 kcmil	1/4	.75	1.39	2.30	.18	3.59	Blue	P76	19	76	2 3/8	6
LCC400-38DWH-6		3/8	1.00	1.39	2.30	.18	4.07	Blue	P76	19	76	2 3/8	6
◆ LCC400-12WH-6		1/2	1.75	1.28	2.30	.17	5.24	Blue	P76	19	76	2 3/8	6
LCC500-14BWH-6	500 kcmil	1/4	.75	1.54	2.50	.22	3.80	Brown	P87	20	87	2 5/8	6
LCC500-38DWH-6		3/8	1.00	1.54	2.50	.22	4.29	Brown	P87	20	87	2 5/8	6
◆ LCC500-12WH-6		1/2	1.75	1.54	2.50	.22	5.46	Brown	P87	20	87	2 5/8	6
LCC600-38DWH-6	600 kcmil	3/8	1.00	1.70	2.69	.26	4.47	Green	P94	22	94	2 3/4	6
◆ LCC600-12WH-6		1/2	1.75	1.70	2.69	.26	5.65	Green	P94	22	94	2 3/4	6

‡See [pages L12, L13 and L14, L15](#) in Technical Info section for tool and die information.

*Not tested to NEBS Level 3 requirements.

**Consult cable manufacturer for voltage stress relief instructions with applications greater than 2000 volts.

◆NEMA hole sizes and spacing

System Overview

Terminals

Disconnects

Splices

Ferrules

Compression Connectors

Crimping Tools

Mechanical Connectors

Grounding Connectors

Support Products

Technical Info

Index

System Overview

NEW!



Code Conductor, Two-Hole, Long Barrel with Window Lug, 90° Angle

Terminals

For Use with Stranded Copper Conductors

Type LCC-WF

- Long barrel maximizes number of crimps and provides premium wire pull-out strength and electrical performance
- Inspection window to visually assure full conductor insertion
- Color coded barrels marked with **PANDUIT®** and specified competitor die index numbers for proper crimp die selection
- Tin plated to inhibit corrosion
- UL Listed for use up to 35KV**, temperature rated 90°C and CSA Certified to 600V when crimped with **PANDUIT®** and specified competitor crimping tools and dies
- UL Listed and CSA Certified for wire range-taking capability when crimped with **PANDUIT® UNI-DIE™** dieless crimping tools‡
- **Tested by Telcordia — meets NEBS Level 3**
- Meets TIA-607 requirements for network systems grounding applications
- Available with NEMA hole sizes and spacing

Disconnects

Splices

Ferrules

Compression Connectors

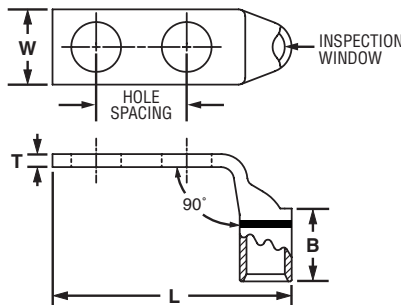

Crimping Tools

Mechanical Connectors

Grounding Connectors

Support Products

Technical Info

Index

Part Number	Copper Conductor Size	Stud Hole Size (In.)	Stud Hole Spacing (In.)	Figure Dimensions (In.)				PANDUIT® Color Code	PANDUIT® Die Index No.‡	Burndy Die Index No.‡	T&B Die Index No.‡	Wire Strip Length (In.)	Std. Pkg. Qty.
				W	B	T	L						
LCC10-14AWF-L*	#14 – #10 AWG STR #12 – #10 AWG SOL	1/4	.63	.42	.53	.05	1.56	—	—	—	—	9/16	50
LCC10-14BWF-L*		1/4	.75	.42	.53	.05	1.69	—	—	—	—	9/16	50
LCC8-10AWF-L	#8 AWG	#10	.63	.41	.70	.08	1.53	Red	P21	49	21	3/4	50
LCC8-10BWF-L		#10	.75	.41	.70	.08	1.65	Red	P21	49	21	3/4	50
LCC8-14AWF-L		1/4	.63	.48	.70	.07	1.61	Red	P21	49	21	3/4	50
LCC8-14BWF-L		1/4	.75	.48	.70	.07	1.74	Red	P21	49	21	3/4	50
LCC8-14DWF-L		1/4	1.00	.48	.70	.07	1.99	Red	P21	49	21	3/4	50
LCC8-38DWF-L	#8 AWG	3/8	1.00	.60	.70	.05	2.21	Red	P21	49	21	3/4	50
LCC6-10AWF-L	#6 AWG	#10	.63	.46	1.07	.08	1.57	Blue	P24	7	24	1 1/8	50
LCC6-10BWF-L		#10	.75	.46	1.07	.08	1.69	Blue	P24	7	24	1 1/8	50
LCC6-14JWF-L		1/4	.50	.48	1.07	.08	1.53	Blue	P24	7	24	1 1/8	50
LCC6-14AWF-L		1/4	.63	.48	1.07	.08	1.66	Blue	P24	7	24	1 1/8	50
LCC6-14BWF-L		1/4	.75	.48	1.07	.08	1.78	Blue	P24	7	24	1 1/8	50
LCC6-14DWF-L		1/4	1.00	.48	1.07	.08	2.03	Blue	P24	7	24	1 1/8	50
LCC6-14EWF-L		1/4	1.25	.48	1.07	.08	2.28	Blue	P24	7	24	1 1/8	50
LCC6-56BWF-L		5/16	.75	.56	1.07	.07	1.90	Blue	P24	7	24	1 1/8	50
LCC6-38BWF-L		3/8	.75	.62	1.07	.06	2.00	Blue	P24	7	24	1 1/8	50
LCC6-38CWF-L		3/8	.88	.62	1.07	.06	2.13	Blue	P24	7	24	1 1/8	50
LCC6-38DWF-L	3/8	1.00	.62	1.07	.06	2.25	Blue	P24	7	24	1 1/8	50	

PANDUIT® TERMINATION SOLUTIONS



Code Conductor, Two-Hole, Long Barrel with Window Lug, 90° Angle (continued)

Part Number	Copper Conductor Size	Stud Hole Size (In.)	Stud Hole Spacing (In.)	Figure Dimensions (In.)				PANDUIT® Color Code	PANDUIT® Die Index No.‡	Burndy Die Index No.‡	T&B Die Index No.‡	Wire Strip Length (In.)	Std. Pkg. Qty.	
				W	B	T	L							
LCC4-10AWF-L	#4 AWG – #3 AWG STR, #2 AWG SOL	#10	.63	.55	1.05	.09	1.65	Gray	P29	8	29	1 1/8	50	
LCC4-10BWF-L		#10	.75	.55	1.05	.09	1.78	Gray	P29	8	29	1 1/8	50	
LCC4-14AWF-L		1/4	.63	.55	1.05	.09	1.74	Gray	P29	8	29	1 1/8	50	
LCC4-14BWF-L		1/4	.75	.55	1.05	.09	1.87	Gray	P29	8	29	1 1/8	50	
LCC4-38DWF-L		3/8	1.00	.62	1.05	.08	2.34	Gray	P29	8	29	1 1/8	50	
LCC2-10AWF-Q	#2 AWG	#10	.63	.60	1.16	.10	1.76	Brown	P33	10	33	1 1/4	25	
LCC2-10BWF-Q		#10	.75	.60	1.16	.10	1.89	Brown	P33	10	33	1 1/4	25	
LCC2-14AWF-Q		1/4	.63	.60	1.16	.10	1.86	Brown	P33	10	33	1 1/4	25	
LCC2-14BWF-Q		1/4	.75	.60	1.16	.10	1.99	Brown	P33	10	33	1 1/4	25	
LCC2-14DWF-Q		1/4	1.00	.60	1.16	.10	2.24	Brown	P33	10	33	1 1/4	25	
LCC2-56BWF-Q		5/16	.75	.66	1.16	.10	2.11	Brown	P33	10	33	1 1/4	25	
LCC2-56CWF-Q		5/16	.88	.66	1.16	.10	2.24	Brown	P33	10	33	1 1/4	25	
LCC2-38BWF-Q		3/8	.75	.66	1.16	.10	2.19	Brown	P33	10	33	1 1/4	25	
LCC2-38CWF-Q		3/8	.88	.66	1.16	.10	2.31	Brown	P33	10	33	1 1/4	25	
LCC2-38DWF-Q		3/8	1.00	.66	1.16	.10	2.44	Brown	P33	10	33	1 1/4	25	
LCC2-38WF-Q		3/8	1.75	.66	1.16	.10	3.19	Brown	P33	10	33	1 1/4	25	
LCC2-12WF-Q		1/2	1.75	.75	1.16	.08	3.61	Brown	P33	10	33	1 1/4	25	
LCC1-14AWF-E		#1 AWG	1/4	.63	.70	1.36	.11	1.94	Green	P37	11	37	1 7/16	20
LCC1-14BWF-E			1/4	.75	.70	1.36	.11	2.06	Green	P37	11	37	1 7/16	20
LCC1-56BWF-E			5/16	.75	.70	1.36	.11	2.19	Green	P37	11	37	1 7/16	20
LCC1-56CWF-E	5/16		.88	.70	1.36	.11	2.31	Green	P37	11	37	1 7/16	20	
LCC1-38DWF-E	3/8		1.00	.70	1.36	.11	2.51	Green	P37	11	37	1 7/16	20	
LCC1-12WF-E	1/2		1.75	.75	1.36	.09	3.68	Green	P37	11	37	1 7/16	20	
LCC1/0-14AWF-X	1/0 AWG	1/4	.63	.76	1.44	.12	2.08	Pink	P42	12	42	1 1/2	10	
LCC1/0-14BWF-X		1/4	.75	.76	1.44	.12	2.20	Pink	P42	12	42	1 1/2	10	
LCC1/0-14DWF-X		1/4	1.00	.76	1.44	.12	2.45	Pink	P42	12	42	1 1/2	10	
LCC1/0-38DWF-X		3/8	1.00	.76	1.44	.12	2.58	Pink	P42	12	42	1 1/2	10	
LCC1/0-38WF-X		3/8	1.75	.76	1.44	.12	3.33	Pink	P42	12	42	1 1/2	10	
LCC1/0-12DWF-X		1/2	1.00	.80	1.44	.12	2.85	Pink	P42	12	42	1 1/2	10	
LCC2/0-14AWF-X	2/0 AWG	1/4	.63	.85	1.50	.13	2.22	Black	P45	13	45	1 9/16	10	
LCC2/0-14BWF-X		1/4	.75	.85	1.50	.13	2.34	Black	P45	13	45	1 9/16	10	
LCC2/0-56DWF-X		5/16	1.00	.85	1.50	.13	2.59	Black	P45	13	45	1 9/16	10	
LCC2/0-38DWF-X		3/8	1.00	.85	1.50	.13	2.66	Black	P45	13	45	1 9/16	10	
LCC2/0-12DWF-X		1/2	1.00	.85	1.50	.13	2.91	Black	P45	13	45	1 9/16	10	
LCC2/0-12WF-X		1/2	1.75	.85	1.50	.13	3.82	Black	P45	13	45	1 9/16	10	
LCC3/0-14BWF-X	3/0 AWG	1/4	.75	.96	1.50	.13	2.42	Orange	P50	14	50	1 9/16	10	
LCC3/0-56DWF-X		5/16	1.00	.96	1.50	.13	2.67	Orange	P50	14	50	1 9/16	10	
LCC3/0-38DWF-X		3/8	1.00	.96	1.50	.13	2.73	Orange	P50	14	50	1 9/16	10	
LCC3/0-12DWF-X		1/2	1.00	.96	1.50	.13	2.98	Orange	P50	14	50	1 9/16	10	
LCC3/0-12WF-X		1/2	1.75	.96	1.50	.13	3.89	Orange	P50	14	50	1 9/16	10	
LCC4/0-14AWF-X	4/0 AWG	1/4	.63	1.06	1.56	.14	2.38	Purple	P54	15	54	1 5/8	10	
LCC4/0-14BWF-X		1/4	.75	1.06	1.56	.14	2.50	Purple	P54	15	54	1 5/8	10	
LCC4/0-56DWF-X		5/16	1.00	1.06	1.56	.14	2.77	Purple	P54	15	54	1 5/8	10	
LCC4/0-38DWF-X		3/8	1.00	1.06	1.56	.14	2.84	Purple	P54	15	54	1 5/8	10	
LCC4/0-38WF-X		3/8	1.75	1.06	1.56	.14	3.59	Purple	P54	15	54	1 5/8	10	
LCC4/0-12DWF-X		1/2	1.00	1.06	1.56	.14	3.07	Purple	P54	15	54	1 5/8	10	
LCC4/0-12WF-X		1/2	1.75	1.06	1.56	.14	3.98	Purple	P54	15	54	1 5/8	10	

Chart continues on page F54

System Overview

Terminals

Disconnects

Splices

Ferrules

Compression Connectors

Crimping Tools

Mechanical Connectors

Grounding Connectors

Support Products

Technical Info

Index

System Overview



Code Conductor, Two-Hole, Long Barrel with Window Lug, 90° Angle (continued)

Terminals

Disconnects

Splices

Ferrules

Compression Connectors

Crimping Tools

Mechanical Connectors

Grounding Connectors

Support Products

Technical Info

Index

Part Number	Copper Conductor Size	Stud Hole Size (In.)	Stud Hole Spacing (In.)	Figure Dimensions (In.)				PANDUIT® Color Code	PANDUIT® Die Index No.‡	Burndy Die Index No.‡	T&B Die Index No.‡	Wire Strip Length (In.)	Std. Pkg. Qty.
				W	B	T	L						
LCC250-56DWF-X	250 kcmil	5/16	1.00	1.17	1.61	.14	2.83	Yellow	P62	16	62	1 11/16	10
LCC250-38DWF-X		3/8	1.00	1.17	1.61	.14	2.90	Yellow	P62	16	62	1 11/16	10
LCC250-12DWF-X		1/2	1.00	1.17	1.61	.14	3.13	Yellow	P62	16	62	1 11/16	10
◆ LCC250-12WF-X		1/2	1.75	1.17	1.61	.14	4.04	Yellow	P62	16	62	1 11/16	10
LCC300-38DWF-X	300 kcmil	3/8	1.00	1.19	2.24	.16	2.88	White	P66	17	66	2 5/16	10
◆ LCC300-12WF-X		1/2	1.75	1.19	2.24	.16	4.06	White	P66	17	66	2 5/16	10
LCC350-14BWF-X	350 kcmil	1/4	.75	1.28	2.24	.17	2.46	Red	P71	18	71	2 5/16	10
LCC350-38DWF-X		3/8	1.00	1.28	2.24	.17	2.94	Red	P71	18	71	2 5/16	10
◆ LCC350-12WF-X		1/2	1.75	1.28	2.24	.17	4.12	Red	P71	18	71	2 5/16	10
LCC400-14BWF-6	400 kcmil	1/4	.75	1.39	2.30	.18	2.54	Blue	P76	19	76	2 3/8	6
LCC400-38DWF-6		3/8	1.00	1.39	2.30	.18	3.02	Blue	P76	19	76	2 3/8	6
◆ LCC400-12WF-6		1/2	1.75	1.39	2.30	.18	4.20	Blue	P76	19	76	2 3/8	6
LCC500-14BWF-6	500 kcmil	1/4	.75	1.54	2.50	.22	2.65	Brown	P87	20	87	2 9/16	6
LCC500-38DWF-6		3/8	1.00	1.54	2.50	.22	3.13	Brown	P87	20	87	2 9/16	6
◆ LCC500-12WF-6		1/2	1.75	1.54	2.50	.22	4.31	Brown	P87	20	87	2 9/16	6
LCC600-38DWF-6	600 kcmil	3/8	1.00	1.70	2.69	.26	3.26	Green	P94	22	94	2 3/4	6
◆ LCC600-12WF-6		1/2	1.75	1.70	2.69	.26	4.44	Green	P94	22	94	2 3/4	6

‡See pages L12, L13 and L14, L15 in Technical Info section for tool and die information.

*Not tested to NEBS Level 3 requirements.

**Consult cable manufacturer for voltage stress relief instructions with applications greater than 2000 volts.

◆NEMA hole sizes and spacing

NEW!



Code Conductor, Two-Hole, Long Barrel with Window, Narrow Tongue Lug

For Use with Stranded Copper Conductors

Type LCCN-W

- Narrow tongue width for limited space applications
- Long barrel maximizes number of crimps and provides premium wire pull-out strength and electrical performance
- Inspection window to visually assure full conductor insertion
- Color coded barrels marked with PANDUIT® and specified competitor die index numbers for proper crimp die selection
- Tin plated to inhibit corrosion
- UL Listed for use up to 35KV**, temperature rated 90°C and CSA Certified to 600V when crimped with PANDUIT® and specified competitor crimping tools and dies
- UL Listed and CSA Certified for wire range-taking capability when crimped with PANDUIT® UNI-DIE™ dieless crimping tools‡
- Tested by Telcordia — meets NEBS Level 3**
- Meets TIA-607 requirements for network systems grounding applications
- Available with NEMA hole sizes and spacing

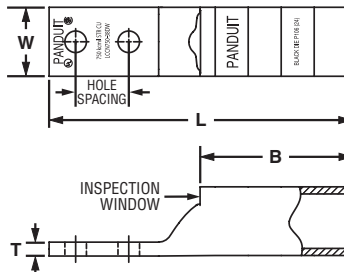

Part Number	Copper Conductor Size	Stud Hole Size (In.)	Stud Hole Spacing (In.)	Figure Dimensions (In.)				PANDUIT® Color Code	PANDUIT® Die Index No.‡	Burndy Die Index No.‡	T&B Die Index No.‡	Wire Strip Length (In.)	Std. Pkg. Qty.
				W	B	T	L						
LCCN750-38DW-6	750 kcmil	3/8	1.00	1.30	2.88	.26	5.72	Black	P106	24	106	2 15/16	6
◆ LCCN750-12W-6	750 kcmil	1/2	1.75	1.30	2.88	.26	6.66	Black	P106	24	106	2 15/16	6

‡See pages L12, L13 and L14, L15 in Technical Info section for tool and die information.

**Consult cable manufacturer for voltage stress relief instructions with applications greater than 2000 volts.

◆NEMA hole sizes and spacing



Code Conductor, Two-Hole, Long Barrel with Corona Relief Taper Lug

To Facilitate Use with Stranded Copper Conductors in Applications of 5000V or More

Type LCCH

- Externally chamfered barrel end inhibits Corona effect when used in high voltage applications
- Long barrel maximizes number of crimps and provides premium wire pull-out strength and electrical performance
- Color coded barrels marked with **PANDUIT®** and specified competitor die index numbers for proper crimp die selection
- Enclosed barrel prevents corrosive material from entering barrel when used in harsh environments
- Tin plated to inhibit corrosion
- UL Listed for use up to 35KV**, temperature rated 90°C and CSA Certified to 600V when crimped with **PANDUIT®** and specified competitor crimping tools and dies
- Available with NEMA hole sizes and spacing

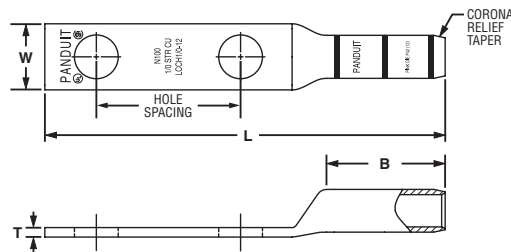

Part Number	Copper Conductor Size	Stud Hole Size (In.)	Stud Hole Spacing (In.)	Figure Dimensions (In.)				PANDUIT® Color Code	PANDUIT® Die Index No.‡	Burdny Die Index No.‡	T&B Die Index No.‡	Wire Strip Length (In.)	Std. Pkg. Qty.
				W	B	T	L						
LCCH1/0-12-X	1/0 AWG	1/2	1.75	.80	1.44	.12	4.86	Pink	P42	12	42	1 1/2	10
LCCH2/0-12-X	2/0 AWG	1/2	1.75	.85	1.50	.13	4.98	Black	P45	13	45	1 9/16	10
LCCH3/0-12-X	3/0 AWG	1/2	1.75	.96	1.50	.13	5.03	Orange	P50	14	50	1 9/16	10
◆ LCCH4/0-12-X	4/0 AWG	1/2	1.75	1.06	1.56	.14	5.13	Purple	P54	15	54	1 5/8	10
◆ LCCH250-12-X	250 kcmil	1/2	1.75	1.17	1.61	.14	5.23	Yellow	P62	16	62	1 1/16	10
◆ LCCH300-12-X	300 kcmil	1/2	1.75	1.19	2.24	.16	5.94	White	P66	17	66	2 5/16	10
◆ LCCH350-12-X	350 kcmil	1/2	1.75	1.28	2.24	.17	5.99	Red	P71	18	71	2 5/16	10
◆ LCCH400-12-6	400 kcmil	1/2	1.75	1.39	2.30	.18	6.10	Blue	P76	19	76	2 3/8	6
◆ LCCH500-12-6	500 kcmil	1/2	1.75	1.54	2.50	.22	6.36	Brown	P87	20	87	2 9/16	6
◆ LCCH600-12-6	600 kcmil	1/2	1.75	1.70	2.69	.26	6.63	Green	P94	22	94	2 3/4	6
◆ LCCH750-12-6	750 kcmil	1/2	1.75	1.89	2.88	.26	7.04	Black	P106	24	106	2 15/16	6
◆ LCCH1000-12-3	1000 kcmil	1/2	1.75	2.17	3.00	.32	7.29	White	P125	27	125	3 1/16	3

‡See [pages L16, L17](#) in Technical Info section for tool and die information.

**Consult cable manufacturer for voltage stress relief instructions with applications greater than 2000 volts.

◆NEMA hole sizes and spacing

System Overview

Terminals

Disconnects

Splices

Ferrules

Compression Connectors

Crimping Tools

Mechanical Connectors

Grounding Connectors

Support Products

Technical Info

Index

System Overview

Code Conductor, Blank Tongue, Long Barrel Lug



For Use with Stranded Copper Conductors

Terminals

Type LCC-00

- Long barrel maximizes number of crimps and provides premium wire pull-out strength and electrical performance
- Color coded barrels marked with **PANDUIT®** and specified competitor die index numbers for proper crimp die selection
- Enclosed barrel prevents corrosive material from entering barrel when used in harsh environments
- Tin plated to inhibit corrosion
- UL Recognized for use up to 35KV**, temperature rated 90°C and CSA Certified to 600V when crimped with **PANDUIT®** and specified competitor crimping tools and dies

Disconnects

Splices

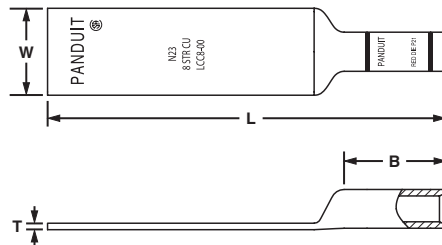

Figure 1

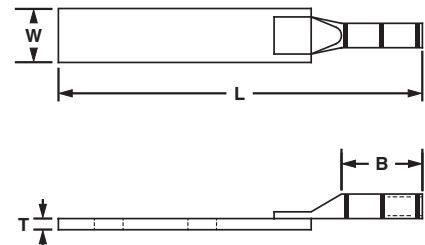

Figure 2: Two Piece Brazed Tongue Construction

Ferrules

Compression Connectors

Part Number	Figure No.	Copper Conductor Size	Figure Dimensions (In.)				PANDUIT® Color Code	PANDUIT® Die Index No.‡	Burndy Die Index No.‡	T&B Die Index No.‡	Wire Strip Length (In.)	Std. Pkg. Qty.
			W	B	T	L						
LCC8-00-L	1	#8 AWG	.60	.70	.05	2.75	Red	P21	49	21	3/4	50
LCC6-00-L	2	#6	.75	1.13	.16	5.00	Blue	P24	7	24	1 1/8	50
LCC4-00-L	2	#4 AWG – #3 AWG STR, #2 AWG SOL	.75	1.13	.16	5.06	Gray	P29	8	29	1 1/8	50
LCC2-00-Q	1	#2 AWG	.75	1.16	.08	4.51	Brown	P33	10	33	1 1/4	25
LCC1-00-E	1	#1 AWG	.75	1.36	.09	4.74	Green	P37	11	37	1 7/16	20
LCC1/0-00-X	1	1/0 AWG	.80	1.44	.12	4.86	Pink	P42	12	42	1 1/2	10
LCC2/0-00-X	1	2/0 AWG	.85	1.50	.13	4.98	Black	P45	13	45	1 9/16	10
LCC3/0-00-X	1	3/0 AWG	.96	1.50	.13	5.03	Orange	P50	14	50	1 9/16	10
LCC4/0-00-X	1	4/0 AWG	1.06	1.56	.14	5.13	Purple	P54	15	54	1 5/8	10
LCC250-00-X	1	250 kcmil	1.17	1.60	.14	5.23	Yellow	P62	16	62	1 11/16	10
LCC300-00-X	1	300 kcmil	1.19	2.23	.16	5.94	White	P66	17	66	2 5/16	10
LCC350-00-X	1	350 kcmil	1.28	2.23	.17	5.99	Red	P71	18	71	2 5/16	10
LCC400-00-6	1	400 kcmil	1.39	2.29	.18	6.10	Blue	P76	19	76	2 3/8	6
LCC500-00-6	1	500 kcmil	1.54	2.49	.22	6.36	Brown	P87	20	87	2 9/16	6
LCC600-00-6	1	600 kcmil	1.70	2.68	.26	6.63	Green	P94	22	94	2 3/4	6
LCC750-00-6	1	750 kcmil	1.89	2.87	.26	7.04	Black	P106	24	106	2 15/16	6
LCC1000-00-3	1	1000 kcmil	2.17	2.99	.32	7.29	White	P125	27	125	3 1/16	3

‡See [pages L12, L13 and L14, L15](#) in Technical Info section for tool and die information.
 **Consult cable manufacturer for voltage stress relief instructions with applications greater than 2000 volts.

Support Products

Technical Info

Index

NEW!



Code Conductor, Blank Tongue, Long Barrel with Window Lug

For Use with Stranded Copper Conductors

Type LCC-00W

- Long barrel maximizes number of crimps and provides premium wire pull-out strength and electrical performance
- Inspection window to visually assure full conductor insertion
- Color coded barrels marked with **PANDUIT®** and specified competitor die index numbers for proper crimp die selection
- Enclosed barrel prevents corrosive material from entering barrel when used in harsh environments
- Tin plated to inhibit corrosion
- UL Recognized for use up to 35KV**, temperature rated 90°C and CSA Certified to 600V when crimped with **PANDUIT®** and specified competitor crimping tools and dies

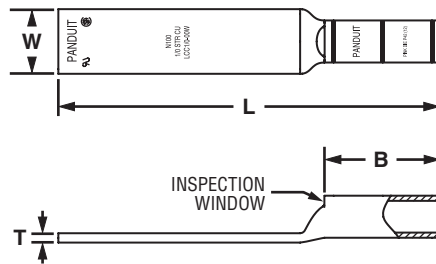

Part Number	Copper Conductor Size	Figure Dimensions (In.)				PANDUIT® Color Code	PANDUIT® Die Index No.‡	Burndy Die Index No.‡	T&B Die Index No.‡	Wire Strip Length (In.)	Std. Pkg. Qty.
		W	B	T	L						
LCC8-00W-L	#8 AWG	.60	.70	.05	2.70	Red	P21	49	21	3/4	50
LCC6-00W-L	#6 AWG	.62	1.07	.06	3.08	Blue	P24	7	24	1 1/8	50
LCC4-00W-L	#4 AWG	.62	1.05	.08	3.09	Gray	P29	8	29	1 1/8	50
LCC2-00W-Q	#2 AWG	.75	1.16	.08	4.41	Brown	P33	10	33	1 1/4	25
LCC1-00W-E	#1 AWG	.75	1.36	.09	4.63	Green	P37	11	37	1 7/16	20
LCC1/0-00W-X	1/0 AWG	.80	1.44	.12	4.74	Pink	P42	12	42	1 1/2	10
LCC2/0-00W-X	2/0 AWG	.85	1.50	.13	4.83	Black	P45	13	45	1 9/16	10
LCC3/0-00W-X	3/0 AWG	.96	1.50	.13	4.87	Orange	P50	14	50	1 9/16	10
LCC4/0-00W-X	4/0 AWG	1.06	1.56	.14	4.95	Purple	P54	15	54	1 5/8	10
LCC250-00W-X	250 kcmil	1.17	1.61	.14	5.04	Yellow	P62	16	62	1 11/16	10
LCC300-00W-X	300 kcmil	1.19	2.24	.16	5.73	White	P66	17	66	2 5/16	10
LCC350-00W-X	350 kcmil	1.28	2.24	.17	5.77	Red	P71	18	71	2 5/16	10
LCC400-00W-6	400 kcmil	1.28	2.30	.17	5.85	Blue	P76	19	76	2 3/8	6
LCC500-00W-6	500 kcmil	1.54	2.50	.22	6.13	Brown	P87	20	87	2 9/16	6
LCC600-00W-6	600 kcmil	1.70	2.69	.26	6.37	Green	P94	22	94	2 3/4	6

‡See pages L12, L13 and L14, L15 in Technical Info section for tool and die information.

**Consult cable manufacturer for voltage stress relief instructions with applications greater than 2000 volts.

System Overview

Terminals

Disconnects

Splices

Ferrules

Compression Connectors

Crimping Tools

Mechanical Connectors

Grounding Connectors

Support Products

Technical Info

Index

System Overview



Code Conductor, Short Barrel, Butt Splice

For Use with Stranded Copper Conductors

Terminals

Type SCSS

- Short barrel for limited space applications
- Color coded barrels marked with **PANDUIT®** and specified competitor die index numbers for proper crimp die selection
- Internal wire stops to prevent over-insertion of conductor
- Tin plated to inhibit corrosion
- UL Listed for use up to 35KV**, temperature rated 90°C and CSA Certified to 600V when crimped with **PANDUIT®** and specified competitor crimping tools and dies
- **Tested by Telcordia — meets NEBS Level 3**

Disconnects

Splices

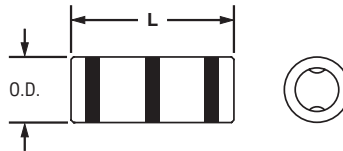

Ferrules

Compression Connectors

Part Number	Copper Conductor Size	Figure Dimensions (In.)		PANDUIT® Color Code	PANDUIT® Die Index No.‡	Burdny Die Index No.‡	T&B Die Index No.‡	Wire Strip Length (In.)	Std. Pkg. Qty.
		Barrel O.D.	L						
SCSS8-L	#8 AWG	.27	1.00	Red	P21	49	21	7/16	50
SCSS6-L	#6 AWG	.31	1.00	Blue	P24	7	24	7/16	50
SCSS4-L	#4 AWG	.38	1.00	Gray	P29	8	29	7/16	50
SCSS2-Q	#2 AWG	.42	1.25	Brown	P33	10	33	9/16	25
SCSS1-Q	#1 AWG	.46	1.44	Green	P37	11	37	11/16	25
SCSS1/0-X	1/0 AWG	.52	1.44	Pink	P42	12	42	11/16	10
SCSS2/0-X	2/0 AWG	.58	1.56	Black	P45	13	45	3/4	10
SCSS3/0-X	3/0 AWG	.64	1.69	Orange	P50	14	50	3/4	10
SCSS4/0-X	4/0 AWG	.71	1.81	Purple	P54	15	54	13/16	10
SCSS250-X	250 kcmil	.77	2.19	Yellow	P62	16	62	1 1/16	10

Crimping Tools

Mechanical Connectors

‡See [pages L6, L7](#) in Technical Info section for tool and die information.
 **Consult cable manufacturer for voltage stress relief instructions with applications greater than 2000 volts.

Grounding Connectors

Support Products

Technical Info

Index



Code Conductor, Standard Barrel, Butt Splice

For Use with Stranded Copper Conductors

Type SCS

- Color coded barrels marked with **PANDUIT®** and specified competitor die index numbers for proper crimp die selection
- Internal wire stops to prevent over-insertion of conductor
- Tin plated to inhibit corrosion
- UL Listed for use up to 35KV**, temperature rated 90°C and CSA Certified to 600V when crimped with **PANDUIT®** and specified competitor crimping tools and dies

- UL Listed and CSA Certified for wire range-taking capability when crimped with **PANDUIT® UNI-DIE™** dieless crimping tool‡
- **Tested by Telcordia — meets NEBS Level 3**

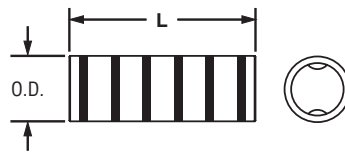

Part Number	Copper Conductor Size	Figure Dimensions (In.)		PANDUIT® Color Code	PANDUIT® Die Index No.‡	Burdny Die Index No.‡	T&B Die Index No.‡	Wire Strip Length (In.)	Std. Pkg. Qty.
		Barrel O.D.	L						
SCS8-L	#8 AWG	.27	1.50	Red	P21	49	21	11/16	50
SCS6-L	#6 AWG	.31	1.75	Blue	P24	7	24	13/16	50
SCS4-L	#4 AWG – #3 AWG STR, #2 AWG SOL	.38	1.75	Gray	P29	8	29	13/16	50
SCS2-Q	#2 AWG	.42	1.87	Brown	P33	10	33	7/8	25
SCS1-E	#1 AWG	.47	1.87	Green	P37	11	37	7/8	20
SCS1/0-X	1/0 AWG	.52	1.87	Pink	P42	12	42	7/8	10
SCS2/0-X	2/0 AWG	.58	2.00	Black	P45	13	45	15/16	10
SCS3/0-X	3/0 AWG	.64	2.12	Orange	P50	14	50	1	10
SCS4/0-X	4/0 AWG	.71	2.12	Purple	P54	15	54	1	10
SCS250-X	250 kcmil	.77	2.25	Yellow	P62	16	62	1 1/16	10
SCS300-X	300 kcmil	.81	2.25	White	P66	17	66	1 1/16	10
SCS350-X	350 kcmil	.87	2.37	Red	P71	18	71	1 1/8	10
SCS400-6	400 kcmil	.95	2.50	Blue	P76	19	76	1 3/16	6
SCS500-6	500 kcmil	1.05	2.87	Brown	P87	20	87	1 3/8	6
SCS600-6	600 kcmil	1.18	2.87	Green	P94	22	94	1 3/8	6
SCS750-6	750 kcmil	1.29	3.37	Black	P106	24	106	1 5/8	6
SCS1000-3	1000 kcmil	1.50	3.87	White	P125	27	125	1 7/8	3

‡See [pages L8, L9 and L10, L11](#) in Technical Info section for tool and die information.

**Consult cable manufacturer for voltage stress relief instructions with applications greater than 2000 volts.

System Overview

Terminals

Disconnects

Splices

Ferrules

Compression Connectors

Crimping Tools

Mechanical Connectors

Grounding Connectors

Support Products

Technical Info

Index

System Overview



Code Conductor, Long Barrel, Butt Splice

For Use with Stranded Copper Conductors

Type SCL

Terminals

- Long barrel maximizes the number of crimps and provides premium wire pull-out strength and electrical performance
- Color coded barrels marked with **PANDUIT®** and specified competitor die index numbers for proper crimp die selection
- Internal wire stops to prevent over-insertion of conductor
- Tin plated to inhibit corrosion

- UL Listed for use up to 35KV**, temperature rated 90°C and CSA Certified to 600V when crimped with **PANDUIT®** and specified competitor crimping tools and dies
- UL Listed and CSA Certified for wire range-taking capability when crimped with **PANDUIT® UNI-DIE™** dieless crimping tools‡
- **Tested by Telcordia — meets NEBS Level 3**

Disconnects

Splices

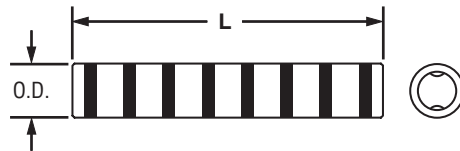

Ferrules

Part Number	Copper Conductor Size	Figure Dimensions (In.)		PANDUIT® Color Code	PANDUIT® Die Index No.‡	Burndy Die Index No.‡	T&B Die Index No.‡	Wire Strip Length (In.)	Std. Pkg. Qty.
		Barrel O.D.	L						
SCL8-L	#8 AWG	.27	2.25	Red	P21	49	21	1 1/16	50
SCL6-L	#6 AWG	.31	2.38	Blue	P24	7	24	1 1/8	50
SCL4-L	#4 AWG – #3 AWG STR, #2 AWG SOL	.38	2.38	Gray	P29	8	29	1 1/8	50
SCL2-Q	#2 AWG	.42	2.62	Brown	P33	10	33	1 1/4	25
SCL1-E	#1 AWG	.47	2.87	Green	P37	11	37	1 3/8	20
SCL1/0-X	1/0 AWG	.52	2.87	Pink	P42	12	42	1 3/8	10
SCL2/0-X	2/0 AWG	.58	3.13	Black	P45	13	45	1 1/2	10
SCL3/0-X	3/0 AWG	.64	3.12	Orange	P50	14	54	1 1/2	10
SCL4/0-X	4/0 AWG	.71	3.37	Purple	P54	15	54	1 5/8	10
SCL250-X	250 kcmil	.77	3.38	Yellow	P62	16	62	1 5/8	10
SCL300-X	300 kcmil	.81	4.12	White	P66	17	66	2	10
SCL350-X	350 kcmil	.88	4.12	Red	P71	18	71	2	10
SCL400-6	400 kcmil	.95	4.37	Blue	P76	19	76	2 1/8	6
SCL500-6	500 kcmil	1.06	4.62	Brown	P87	20	87	2 1/4	6
SCL600-6	600 kcmil	1.19	5.50	Green	P94	22	94	2 11/16	6
SCL750-6	750 kcmil	1.30	5.87	Black	P106	24	106	2 7/8	6
SCL1000-3	1000 kcmil	1.50	6.12	White	P125	27	125	3	3

Compression Connectors

Crimping Tools

Mechanical Connectors

Grounding Connectors

‡See [pages L12, L13 and L14, L15](#) in Technical Info section for tool and die information.

**Consult cable manufacturer for voltage stress relief instructions with applications greater than 2000 volts.

Support Products

Technical Info

Index



Code Conductor, Long Barrel with Corona Relief Taper Splice

To Facilitate Use with Stranded Copper Conductors in Applications of 5000V or More

Type SCH

- Externally chamfered barrel end inhibits Corona effect when used in high voltage applications
- Color coded barrels marked with **PANDUIT®** and specified competitor die index numbers for proper crimp die selection
- Internal wire stops to prevent over-insertion of conductor
- Tin plated to inhibit corrosion
- UL Listed for use up to 35KV**, temperature rated 90°C and CSA Certified to 600V when crimped with **PANDUIT®** and specified competitor crimping tools and dies

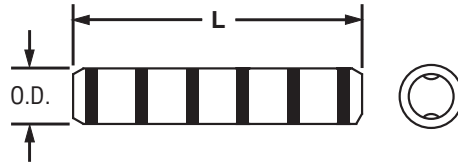

Part Number	Copper Conductor Size	Figure Dimensions (In.)		PANDUIT® Color Code	PANDUIT® Die Index No.‡	Burndy Die Index No.‡	T&B Die Index No.‡	Wire Strip Length (In.)	Std. Pkg. Qty.
		Barrel O.D.	L						
SCH6-L	#6	.31	1.97	Blue	P24	7	24	15/16	50
SCH4-L	#4 AWG	.38	1.97	Gray	P29	8	29	15/16	50
SCH2-Q	#2 AWG	.42	2.13	Brown	P33	10	33	1	25
SCH1-E	#1 AWG	.47	2.13	Green	P37	11	37	1	20
SCH1/0-X	1/0 AWG	.52	2.13	Pink	P42	12	42	1	10
SCH2/0-X	2/0 AWG	.58	2.28	Black	P45	13	45	1 1/16	10
SCH3/0-X	3/0 AWG	.64	2.47	Orange	P50	14	50	1 3/16	10
SCH4/0-X	4/0 AWG	.71	2.54	Purple	P54	15	54	1 3/16	10
SCH250-X	250 kcmil	.77	2.63	Yellow	P62	16	62	1 1/4	10
SCH300-X	300 kcmil	.82	2.69	White	P66	17	66	2	10
SCH350-X	350 kcmil	.88	2.84	Red	P71	18	71	2	10
SCH500-6	500 kcmil	1.06	3.53	Brown	P87	20	87	2 1/4	6
SCH750-6	750 kcmil	1.30	4.28	Black	P106	24	106	2 7/8	6
SCH1000-3	1000 kcmil	1.50	5.06	White	P125	27	125	3	3

‡See [pages L16, L17](#) in Technical Info section for tool and die information.

**Consult cable manufacturer for voltage stress relief instructions with applications greater than 2000 volts.

System Overview

Terminals

Disconnects

Splices

Ferrules

Compression Connectors

Crimping Tools

Mechanical Connectors

Grounding Connectors

Support Products

Technical Info

Index

System Overview

Code Conductor, Long Barrel, T Splice

For Copper-To-Copper Stranded Conductors

Terminals

Type SCT

- Provides a means of connecting the run conductor and taking off a perpendicular tap
- Long barrel maximizes number of crimps and provides premium wire pull-out strength and electrical performance
- Run conductor size and tap conductor size marked on each barrel
- 90°C temperature rated and for use up to 600V when crimped with *PANDUIT®* and specified competitor crimping tools and dies

Disconnects



Splices

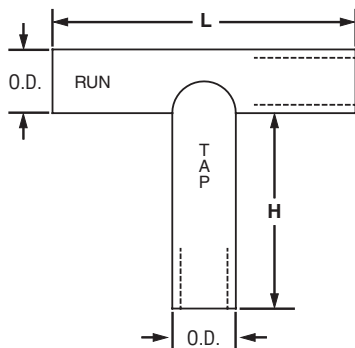

Ferrules

Part Number	Copper Conductor Size		Run O.D.	Tap O.D.	Figure Dimensions (In.)		PANDUIT® Color Code & Die Index No.‡		Burndy Die Index No.‡	T&B Die Index No.‡	Wire Strip Length (In.)		Std. Pkg. Qty.
	Run	Tap			H	L	Run	Tap			Run	Tap	
SCT2-2	#2 AWG	#2 AWG	.42	.42	1.50	3.88	Brown P33	Brown P33	10	33	2	1 9/16	1
SCT1/0-1/0	1/0 AWG	1/0 AWG	.51	.51	1.50	4.00	Pink P42	Pink P42	12	42	2 1/16	1 9/16	1
SCT2/0-2/0	2/0 AWG	2/0 AWG	.56	.56	1.50	4.00	Black P45	Black P45	13	45	2 1/16	1 9/16	1
SCT4/0-1/0	4/0 AWG	1/0 AWG	.69	.51	1.50	4.00	Orange P50	Pink P42	14, 12	50, 42	2 1/16	1 9/16	1
SCT4/0-4/0	4/0 AWG	4/0 AWG	.69	.69	1.63	4.19	Purple P54	Purple P54	15	54	2 1/8	1 11/16	1
SCT250-250	250 kcmil	250 kcmil	.75	.75	1.63	4.25	Yellow P62	Yellow P62	16	62	2 3/16	1 11/16	1
SCT300-300	300 kcmil	300 kcmil	.81	.81	2.00	5.44	White P66	White P66	17	66	2 13/16	2 1/16	1
SCT350-350	350 kcmil	350 kcmil	.88	.88	2.00	5.50	Red P71	Red P71	18	71	2 13/16	2 1/16	1
SCT500-4/0	500 kcmil	4/0 AWG	1.06	.69	2.25	5.81	Brown P87	Purple P54	20, 15	87, 54	2 15/16	2 5/16	1
SCT500-500	500 kcmil	500 kcmil	1.06	1.06	2.50	6.06	Brown P87	Brown P87	20	87	3 1/8	2 9/16	1

‡See [pages L18, L19](#) in Technical Info section for tool and die information.

Mechanical Connectors

Grounding Connectors

Support Products

Technical Info

Index

Code Conductor, Parallel Splice

For Use with Stranded Copper Conductors

Type PS

- Designed to splice a range of conductor sizes with a single connector
- Versatile, can also be used for pigtailing
- Color coded barrels marked with **PANDUIT®** and specified competitor die index numbers for proper crimp die selection
- Tin plated to inhibit corrosion
- 90°C temperature rated and for use up to 600V when crimped with **PANDUIT®** and specified competitor crimping tools and dies

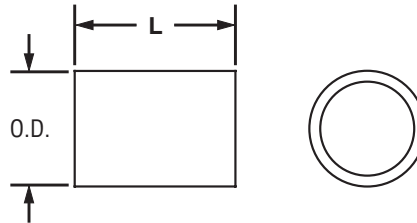

Part Number	Circular MIL Range		Figure Dimensions (In.)		PANDUIT® Color Code	PANDUIT® Die Index No.‡	Burdny Die Index No.‡	T&B Die Index No.‡	Wire Strip Length (In.)	Std. Pkg. Qty.
	Min.	Max.	Barrel O.D.	L						
PS8-L	19,000	25,000	.31	.40	Red	P21	49	21	7/16	50
PS6-L	25,000	40,000	.38	.44	Blue	P24	7	24	1/2	50
PS4-L	40,000	65,000	.42	.54	Gray	P29	8	29	5/8	50
PS2-Q	65,000	100,000	.52	.64	Brown	P33	10	33	11/16	25
PS1-E	100,000	130,000	.58	.67	Green	P37	11	37	3/4	20
PS1/0-X	130,000	160,000	.64	.73	Pink	P42	12	42	13/16	10
PS2/0-X	160,000	200,000	.71	.72	Black	P45	13	45	13/16	10
PS3/0-X	200,000	240,000	.77	.75	Orange	P50	14	50	13/16	10
PS4/0-X	240,000	280,000	.81	.77	Purple	P54	15	54	13/16	10

‡See [pages L20, L21](#) in Technical Info section for tool and die information. For smaller wire sizes, see [page D6](#) in Splice Section.

System Overview

Terminals

Disconnects

Splices

Ferrules

Compression Connectors

Crimping Tools

Mechanical Connectors

Grounding Connectors

Support Products

Technical Info

Index

PANDUIT® TERMINATION SOLUTIONS

System Overview

NEW!



Flex Conductor, One-Hole, Standard Barrel with Window Lug

For Use with Flexible, Extra-Flexible and Code Stranded Copper Conductors

Type LCAX

- Can be used with code conductor and flex conductor class: G, H, I, K, M and Locomotive
- Generously beveled wire entry prevents bent back strands when inserting conductor into barrel
- Color coded barrels marked with **PANDUIT®** and specified competitor die index numbers for proper crimp die selection
- Inspection window to visually assure full conductor insertion
- Tin plated to inhibit corrosion
- UL Listed for use up to 35KV**, temperature rated 90°C and CSA Certified to 600V when crimped with **PANDUIT®** and specified competitor crimping tools and dies

Terminals

Disconnects

Splices

Ferrules

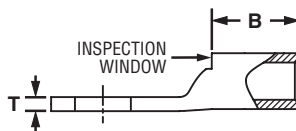
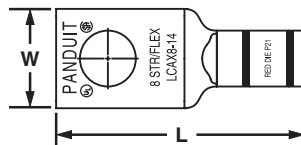

Part Number	Flex Conductor Size		Code Conductor Size	Stud Hole Size (In.)	Figure Dimensions (In.)				PANDUIT® Color Code	PANDUIT® Die Index No. ‡	Wire Strip Length (In.)	Std. Pkg. Qty.
	Class G, H, I, K, M	Locomotive			W	B	T	L				
LCAX8-10-L	#8 AWG	#8 AWG	#8 AWG	#10	.41	.42	.08	1.11	Red	P21	1/2	50
LCAX8-14-L				1/4	.48	.42	.07	1.20	Red	P21	1/2	50
LCAX8-56-L				5/16	.56	.42	.05	1.32	Red	P21	1/2	50
LCAX8-38-L				3/8	.60	.42	.05	1.42	Red	P21	1/2	50
LCAX6-10-L	#6 AWG	#6 AWG	#6 AWG	#10	.45	.48	.09	1.19	Blue	P24	9/16	50
LCAX6-14-L				1/4	.48	.48	.08	1.28	Blue	P24	9/16	50
LCAX6-56-L				5/16	.56	.48	.07	1.40	Blue	P24	9/16	50
LCAX6-38-L				3/8	.62	.48	.06	1.50	Blue	P24	9/16	50
LCAX4-10-L	#4 AWG	#5, #4, #3 AWG	#4 AWG	#10	.55	.53	.09	1.26	Gray	P29	5/8	50
LCAX4-14-L				1/4	.55	.53	.09	1.35	Gray	P29	5/8	50
LCAX4-56-L				5/16	.55	.53	.09	1.47	Gray	P29	5/8	50
LCAX4-38-L				3/8	.62	.53	.07	1.57	Gray	P29	5/8	50
LCAX2-10-E	#2 AWG	#2 AWG	#2 AWG	#10	.70	.59	.11	1.40	Brown	P33	11/16	20
LCAX2-14-E				1/4	.70	.59	.11	1.50	Brown	P33	11/16	20
LCAX2-56-E				5/16	.70	.59	.11	1.63	Brown	P33	11/16	20
LCAX2-38-E				3/8	.70	.59	.11	1.70	Brown	P33	11/16	20
LCAX2-12-E				1/2	.75	.59	.09	1.94	Brown	P33	11/16	20
LCAX1-10-X	#1 AWG	#1 AWG	#1 AWG	#10	.76	.66	.12	1.50	Green	P37	3/4	10
LCAX1-14-X				1/4	.76	.66	.12	1.67	Green	P37	3/4	10
LCAX1-56-X				5/16	.76	.66	.12	1.72	Green	P37	3/4	10
LCAX1-38-X				3/8	.76	.66	.12	1.80	Green	P37	3/4	10
LCAX1-12-X				1/2	.80	.66	.12	2.03	Green	P37	3/4	10
LCAX1/0-14-X	1/0 AWG	1/0 AWG	1/0 AWG	1/4	.85	.72	.13	1.82	Pink	P42	3/4	10
LCAX1/0-56-X				5/16	.85	.72	.13	1.82	Pink	P42	3/4	10
LCAX1/0-38-X				3/8	.85	.72	.13	1.89	Pink	P42	3/4	10
LCAX1/0-12-X				1/2	.85	.72	.13	2.14	Pink	P42	3/4	10
LCAX2/0-10-X	2/0 AWG	2/0 AWG	2/0 AWG	#10	.96	.83	.13	1.72	Black	P45	7/8	10
LCAX2/0-14-X				1/4	.96	.83	.13	1.97	Black	P45	7/8	10
LCAX2/0-56-X				5/16	.96	.83	.13	1.97	Black	P45	7/8	10
LCAX2/0-38-X				3/8	.96	.83	.13	2.03	Black	P45	7/8	10
LCAX2/0-12-X				1/2	.96	.83	.13	2.28	Black	P45	7/8	10
LCAX2/0-58-X				5/8	.96	.83	.13	2.52	Black	P45	7/8	10
LCAX2/0-34-X	3/4	.96	.83	.13	2.88	Black	P45	7/8	10			

PANDUIT® TERMINATION SOLUTIONS



Flex Conductor, One-Hole, Standard Barrel with Window Lug (continued)

Part Number	Flex Conductor Size		Code Conductor Size	Stud Hole Size (In.)	Figure Dimensions (In.)				PANDUIT® Color Code	PANDUIT® Die Index No. ‡	Wire Strip Length (In.)	Std. Pkg. Qty.
	Class G, H, I, K, M	Locomotive			W	B	T	L				
LCAX3/0-10-X	3/0 AWG	3/0 AWG	3/0 AWG	#10	1.06	.91	.14	1.84	Orange	P50	1	10
LCAX3/0-14-X				1/4	1.06	.91	.14	2.08	Orange	P50	1	10
LCAX3/0-56-X				5/16	1.06	.91	.14	2.10	Orange	P50	1	10
LCAX3/0-38-X				3/8	1.06	.91	.14	2.17	Orange	P50	1	10
LCAX3/0-12-X				1/2	1.06	.91	.14	2.40	Orange	P50	1	10
LCAX4/0-14-X	4/0 AWG	4/0 AWG	4/0 AWG	1/4	1.19	1.03	.16	2.30	Purple	P54	1 1/16	10
LCAX4/0-56-X				5/16	1.19	1.03	.16	2.53	Purple	P54	1 1/16	10
LCAX4/0-38-X				3/8	1.19	1.03	.16	2.53	Purple	P54	1 1/16	10
LCAX4/0-12-X				1/2	1.19	1.03	.16	2.64	Purple	P54	1 1/16	10
LCAX4/0-58-X				5/8	1.19	1.03	.16	2.85	Purple	P54	1 1/16	10
LCAX4/0-34-X				3/4	1.19	1.03	.16	3.04	Purple	P54	1 1/16	10
LCAX250-14-X	250 kcmil	262.6 kcmil	—	1/4	1.28	1.03	.17	2.34	Yellow	P62	1 1/16	10
LCAX250-56-X				5/16	1.28	1.03	.17	2.57	Yellow	P62	1 1/16	10
LCAX250-38-X				3/8	1.28	1.03	.17	2.57	Yellow	P62	1 1/16	10
LCAX250-12-X				1/2	1.28	1.03	.17	2.68	Yellow	P62	1 1/16	10
LCAX250-58-X				5/8	1.28	1.03	.17	2.89	Yellow	P62	1 1/16	10
LCAX250-34-X				3/4	1.28	1.03	.17	3.08	Yellow	P62	1 1/16	10
LCAX300-38-6	300 kcmil	313.1 kcmil	—	3/8	1.39	1.19	.18	2.91	Red	P71	1 1/4	6
LCAX300-12-6				1/2	1.39	1.19	.18	2.91	Red	P71	1 1/4	6
LCAX300-58-6				5/8	1.39	1.19	.18	3.12	Red	P71	1 1/4	6
LCAX350-56-6	350 kcmil	373.7 kcmil	—	5/16	1.54	1.29	.22	2.93	Blue	P76	1 3/8	6
LCAX350-38-6				3/8	1.54	1.29	.22	2.93	Blue	P76	1 3/8	6
LCAX350-12-6				1/2	1.54	1.29	.22	3.09	Blue	P76	1 3/8	6
LCAX350-58-6				5/8	1.54	1.29	.22	3.30	Blue	P76	1 3/8	6
LCAX450-12-6	450 kcmil	444.4 kcmil	—	1/2	1.70	1.40	.26	3.60	Brown	P87	1 7/16	6
LCAX450-58-6				5/8	1.70	1.40	.26	3.73	Brown	P87	1 7/16	6
LCAX500-56-6	500 kcmil	535.3 kcmil	—	5/16	1.89	1.48	.26	3.27	Pink	P99	1 9/16	6
LCAX500-38-6				3/8	1.89	1.48	.26	3.27	Pink	P99	1 9/16	6
LCAX500-12-6				1/2	1.89	1.48	.26	3.64	Pink	P99	1 9/16	6
LCAX500-58-6				5/8	1.89	1.48	.26	4.20	Pink	P99	1 9/16	6
LCAX650-56-6	—	646.4 kcmil	—	5/16	1.95	1.45	.30	3.27	Black	P106	1 1/2	6
LCAX650-38-6				3/8	1.95	1.45	.30	3.27	Black	P106	1 1/2	6
LCAX650-12-6				1/2	1.95	1.45	.30	3.64	Black	P106	1 1/2	6
LCAX650-58-6				5/8	1.95	1.45	.30	4.20	Black	P106	1 1/2	6
LCAX750-12-3	—	777.7 kcmil	—	1/2	2.17	1.66	.32	3.94	Yellow	P115	1 3/4	3
LCAX750-58-3				5/8	2.17	1.66	.32	4.59	Yellow	P115	1 3/4	3

‡See pages L22, L23 in Technical Info section for tool and die information.

**Consult cable manufacturer for voltage stress relief instructions with applications greater than 2000 volts.

System Overview

Terminals

Disconnects

Splices

Ferrules

Compression Connectors

Crimping Tools

Mechanical Connectors

Grounding Connectors

Support Products

Technical Info

Index

System Overview

NEW!



Flex Conductor, One-Hole, Standard Barrel with Window Lug, 45° Angle

For Use with Flexible, Extra-Flexible and Code Stranded Copper Conductors

Terminals

Type LCAX-H

- Can be used with code conductor and flex conductor class: G, H, I, K, M and Locomotive
- Generously beveled wire entry prevents bent back strands when inserting conductor into barrel
- Color coded barrels marked with **PANDUIT®** and specified competitor die index numbers for proper crimp die selection
- Inspection window to visually assure full conductor insertion
- Tin plated to inhibit corrosion
- UL Listed for use up to 35KV**, temperature rated 90°C and CSA Certified to 600V when crimped with **PANDUIT®** and specified competitor crimping tools and dies

Disconnects

Splices

Ferrules

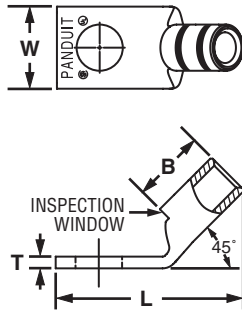

Part Number	Flex Conductor Size		Code Conductor Size	Stud Hole Size (In.)	Figure Dimensions (In.)				PANDUIT® Color Code	PANDUIT® Die Index No. ‡	Wire Strip Length (In.)	Std. Pkg. Qty.
	Class G, H, I, K, M	Locomotive			W	B	T	L				
LCAX8-10H-L	#8 AWG	#8 AWG	#8 AWG	#10	.41	.42	.08	1.00	Red	P21	1/2	50
LCAX8-14H-L				1/4	.48	.42	.07	1.09	Red	P21	1/2	50
LCAX8-56H-L				5/16	.56	.42	.05	1.20	Red	P21	1/2	50
LCAX8-38H-L				3/8	.60	.42	.05	1.30	Red	P21	1/2	50
LCAX6-10H-L	#6 AWG	#6 AWG	#6 AWG	#10	.45	.48	.09	1.06	Blue	P24	9/16	50
LCAX6-14H-L				1/4	.48	.48	.08	1.14	Blue	P24	9/16	50
LCAX6-56H-L				5/16	.56	.48	.07	1.26	Blue	P24	9/16	50
LCAX6-38H-L				3/8	.62	.48	.06	1.35	Blue	P24	9/16	50
LCAX4-10H-L	#4 AWG	#5, #4, #3 AWG	#4 AWG	#10	.55	.53	.09	1.12	Gray	P29	5/8	50
LCAX4-14H-L				1/4	.55	.53	.09	1.21	Gray	P29	5/8	50
LCAX4-56H-L				5/16	.55	.53	.09	1.33	Gray	P29	5/8	50
LCAX4-38H-L				3/8	.62	.53	.07	1.42	Gray	P29	5/8	50
LCAX2-10H-E	#2 AWG	#2 AWG	#2 AWG	#10	.70	.59	.11	1.22	Brown	P33	11/16	20
LCAX2-14H-E				1/4	.70	.59	.11	1.29	Brown	P33	11/16	20
LCAX2-56H-E				5/16	.70	.59	.11	1.42	Brown	P33	11/16	20
LCAX2-38H-E				3/8	.70	.59	.11	1.49	Brown	P33	11/16	20
LCAX2-12H-E				1/2	.75	.59	.09	1.73	Brown	P33	11/16	20
LCAX1-10H-X	#1 AWG	#1 AWG	#1 AWG	#10	.76	.66	.12	1.43	Green	P37	3/4	10
LCAX1-14H-X				1/4	.76	.66	.12	1.43	Green	P37	3/4	10
LCAX1-56H-X				5/16	.76	.66	.12	1.49	Green	P37	3/4	10
LCAX1-38H-X				3/8	.76	.66	.12	1.56	Green	P37	3/4	10
LCAX1-12H-X				1/2	.80	.66	.12	1.80	Green	P37	3/4	10
LCAX1/0-14H-X	1/0 AWG	1/0 AWG	1/0 AWG	1/4	.85	.72	.13	1.58	Pink	P42	3/4	10
LCAX1/0-56H-X				5/16	.85	.72	.13	1.58	Pink	P42	3/4	10
LCAX1/0-38H-X				3/8	.85	.72	.13	1.64	Pink	P42	3/4	10
LCAX1/0-12H-X				1/2	.85	.72	.13	1.89	Pink	P42	3/4	10
LCAX2/0-10H-X	2/0 AWG	2/0 AWG	2/0 AWG	#10	.96	.83	.13	1.56	Black	P45	7/8	10
LCAX2/0-14H-X				1/4	.96	.83	.13	1.68	Black	P45	7/8	10
LCAX2/0-56H-X				5/16	.96	.83	.13	1.68	Black	P45	7/8	10
LCAX2/0-38H-X				3/8	.96	.83	.13	1.74	Black	P45	7/8	10
LCAX2/0-12H-X				1/2	.96	.83	.13	1.99	Black	P45	7/8	10
LCAX2/0-58H-X				5/8	.96	.83	.13	1.99	Black	P45	7/8	10
LCAX2/0-34H-X				3/4	.96	.83	.13	2.12	Black	P45	7/8	10

PANDUIT® TERMINATION SOLUTIONS



Flex Conductor, One-Hole, Standard Barrel with Window Lug, 45° Angle (continued)

Part Number	Flex Conductor Size		Code Conductor Size	Stud Hole Size (In.)	Figure Dimensions (In.)				PANDUIT® Color Code	PANDUIT® Die Index No. ‡	Wire Strip Length (In.)	Std. Pkg. Qty.
	Class G, H, I, K, M	Locomotive			W	B	T	L				
LCAX3/0-10H-X	3/0 AWG	3/0 AWG	3/0 AWG	#10	1.06	.91	.14	1.77	Orange	P50	1	10
LCAX3/0-14H-X				1/4	1.06	.91	.14	1.77	Orange	P50	1	10
LCAX3/0-56H-X				5/16	1.06	.91	.14	1.78	Orange	P50	1	10
LCAX3/0-38H-X				3/8	1.06	.91	.14	1.85	Orange	P50	1	10
LCAX3/0-12H-X				1/2	1.06	.91	.14	2.08	Orange	P50	1	10
LCAX4/0-14H-X	4/0 AWG	4/0 AWG	4/0 AWG	1/4	1.19	1.03	.16	2.03	Purple	P54	1 1/16	10
LCAX4/0-56H-X				5/16	1.19	1.03	.16	2.26	Purple	P54	1 1/16	10
LCAX4/0-38H-X				3/8	1.19	1.03	.16	2.26	Purple	P54	1 1/16	10
LCAX4/0-12H-X				1/2	1.19	1.03	.16	2.37	Purple	P54	1 1/16	10
LCAX4/0-58H-X				5/8	1.19	1.03	.16	2.58	Purple	P54	1 1/16	10
LCAX4/0-34H-X	3/4	1.19	1.03	.16	2.58	Purple	P54	1 1/16	10			
LCAX250-14H-X	250 kcmil	262.6 kcmil	—	1/4	1.28	1.03	.17	2.30	Yellow	P62	1 1/16	10
LCAX250-56H-X				5/16	1.28	1.03	.17	2.30	Yellow	P62	1 1/16	10
LCAX250-38H-X				3/8	1.28	1.03	.17	2.30	Yellow	P62	1 1/16	10
LCAX250-12H-X				1/2	1.28	1.03	.17	2.41	Yellow	P62	1 1/16	10
LCAX250-58H-X				5/8	1.28	1.03	.17	2.62	Yellow	P62	1 1/16	10
LCAX250-34H-X	3/4	1.28	1.03	.17	2.62	Yellow	P62	1 1/16	10			
LCAX300-38H-6	300 kcmil	313.1 kcmil	—	3/8	1.39	1.19	.18	2.64	Red	P71	1 1/4	6
LCAX300-12H-6				1/2	1.39	1.19	.18	2.64	Red	P71	1 1/4	6
LCAX300-58H-6				5/8	1.39	1.19	.18	2.85	Red	P71	1 1/4	6
LCAX350-56H-6	350 kcmil	373.7 kcmil	—	5/16	1.54	1.29	.22	2.62	Blue	P76	1 3/8	6
LCAX350-38H-6				3/8	1.54	1.29	.22	2.62	Blue	P76	1 3/8	6
LCAX350-12H-6				1/2	1.54	1.29	.22	2.78	Blue	P76	1 3/8	6
LCAX350-58H-6	5/8	1.54	1.29	.22	2.99	Blue	P76	1 3/8	6			
LCAX450-12H-6	450 kcmil	444.4 kcmil	—	1/2	1.70	1.40	.26	3.26	Brown	P87	1 7/16	6
LCAX450-58H-6				5/8	1.70	1.40	.26	3.39	Brown	P87	1 7/16	6
LCAX500-56H-6	500 kcmil	535.3 kcmil	—	5/16	1.89	1.48	.26	2.87	Pink	P99	1 9/16	6
LCAX500-38H-6				3/8	1.89	1.48	.26	2.87	Pink	P99	1 9/16	6
LCAX500-12H-6				1/2	1.89	1.48	.26	3.24	Pink	P99	1 9/16	6
LCAX500-58H-6				5/8	1.89	1.48	.26	3.80	Pink	P99	1 9/16	6
LCAX650-56H-6	—	646.4 kcmil	—	5/16	1.95	1.45	.30	2.89	Black	P106	1 1/2	6
LCAX650-38H-6				3/8	1.95	1.45	.30	2.89	Black	P106	1 1/2	6
LCAX650-12H-6				1/2	1.95	1.45	.30	3.26	Black	P106	1 1/2	6
LCAX650-58H-6				5/8	1.95	1.45	.30	3.82	Black	P106	1 1/2	6
LCAX750-12H-3	—	777.7 kcmil	—	1/2	2.17	1.66	.32	3.52	Yellow	P115	1 3/4	3
LCAX750-58H-3				5/8	2.17	1.66	.32	4.18	Yellow	P115	1 3/4	3

‡See pages L22, L23 in Technical Info section for tool and die information.

**Consult cable manufacturer for voltage stress relief instructions with applications greater than 2000 volts.

System Overview

Terminals

Disconnects

Splices

Ferrules

Compression Connectors

Crimping Tools

Mechanical Connectors

Grounding Connectors

Support Products

Technical Info

Index

PANDUIT® TERMINATION SOLUTIONS

System Overview

NEW!



Flex Conductor, One-Hole, Standard Barrel with Window Lug, 90° Angle

Terminals

For Use with Flexible, Extra-Flexible and Code Stranded Copper Conductors

Type LCAX-F

- Can be used with code conductor and flex conductor class: G, H, I, K, M and Locomotive
- Generously beveled wire entry prevents bent back strands when inserting conductor into barrel
- Color coded barrels marked with **PANDUIT®** and specified competitor die index numbers for proper crimp die selection
- Inspection window to visually assure full conductor insertion
- Tin plated to inhibit corrosion
- UL Listed for use up to 35KV**, temperature rated 90°C and CSA Certified to 600V when crimped with **PANDUIT®** and specified competitor crimping tools and dies

Disconnects

Splices

Ferrules

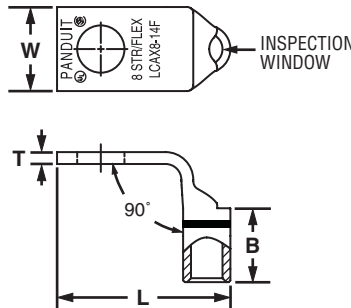

Compression Connectors

Crimping Tools

Mechanical Connectors

Grounding Connectors

Support Products

Technical Info

Index

Part Number	Flex Conductor Size		Code Conductor Size	Stud Hole Size (In.)	Figure Dimensions (In.)				PANDUIT® Color Code	PANDUIT® Die Index No. ‡	Wire Strip Length (In.)	Std. Pkg. Qty.
	Class G, H, I, K, M	Locomotive			W	B	T	L				
LCAX8-10F-L	#8 AWG	#8 AWG	#8 AWG	#10	.41	.42	.08	.90	Red	P21	1/2	50
LCAX8-14F-L				1/4	.48	.42	.07	.99	Red	P21	1/2	50
LCAX8-56F-L				5/16	.56	.42	.05	1.11	Red	P21	1/2	50
LCAX8-38F-L				3/8	.60	.42	.05	1.21	Red	P21	1/2	50
LCAX6-10F-L	#6 AWG	#6 AWG	#6 AWG	#10	.45	.48	.09	.99	Blue	P24	9/16	50
LCAX6-14F-L				1/4	.48	.48	.08	1.03	Blue	P24	9/16	50
LCAX6-56F-L				5/16	.56	.48	.07	1.15	Blue	P24	9/16	50
LCAX6-38F-L				3/8	.62	.48	.06	1.25	Blue	P24	9/16	50
LCAX4-10F-L	#4 AWG	#5, #4, #3 AWG	#4 AWG	#10	.55	.53	.09	1.03	Gray	P29	5/8	50
LCAX4-14F-L				1/4	.55	.53	.09	1.12	Gray	P29	5/8	50
LCAX4-56F-L				5/16	.55	.53	.09	1.24	Gray	P29	5/8	50
LCAX4-38F-L				3/8	.62	.53	.07	1.34	Gray	P29	5/8	50
LCAX2-10F-E	#2 AWG	#2 AWG	#2 AWG	#10	.70	.59	.11	1.21	Brown	P33	11/16	20
LCAX2-14F-E				1/4	.70	.59	.11	1.31	Brown	P33	11/16	20
LCAX2-56F-E				5/16	.70	.59	.11	1.44	Brown	P33	11/16	20
LCAX2-38F-E				3/8	.70	.59	.11	1.51	Brown	P33	11/16	20
LCAX2-12F-E				1/2	.75	.59	.09	1.75	Brown	P33	11/16	20
LCAX1-10F-X	#1 AWG	#1 AWG	#1 AWG	#10	.76	.66	.12	1.28	Green	P37	3/4	10
LCAX1-14F-X				1/4	.76	.66	.12	1.45	Green	P37	3/4	10
LCAX1-56F-X				5/16	.76	.66	.12	1.51	Green	P37	3/4	10
LCAX1-38F-X				3/8	.76	.66	.12	1.58	Green	P37	3/4	10
LCAX1-12F-X				1/2	.80	.66	.12	1.82	Green	P37	3/4	10
LCAX1/0-14F-X	1/0 AWG	1/0 AWG	1/0 AWG	1/4	.85	.72	.13	1.59	Pink	P42	3/4	10
LCAX1/0-56F-X				5/16	.85	.72	.13	1.59	Pink	P42	3/4	10
LCAX1/0-38F-X				3/8	.85	.72	.13	1.66	Pink	P42	3/4	10
LCAX1/0-12F-X				1/2	.85	.72	.13	1.91	Pink	P42	3/4	10
LCAX2/0-10F-X	2/0 AWG	2/0 AWG	2/0 AWG	#10	.96	.83	.13	1.42	Black	P45	7/8	10
LCAX2/0-14F-X				1/4	.96	.83	.13	1.67	Black	P45	7/8	10
LCAX2/0-56F-X				5/16	.96	.83	.13	1.67	Black	P45	7/8	10
LCAX2/0-38F-X				3/8	.96	.83	.13	1.73	Black	P45	7/8	10
LCAX2/0-12F-X				1/2	.96	.83	.13	1.98	Black	P45	7/8	10
LCAX2/0-58F-X				5/8	.96	.83	.13	2.22	Black	P45	7/8	10
LCAX2/0-34F-X				3/4	.96	.83	.13	2.41	Black	P45	7/8	10

PANDUIT® TERMINATION SOLUTIONS



Flex Conductor, One-Hole, Standard Barrel with Window Lug, 90° Angle (continued)

Part Number	Flex Conductor Size		Code Conductor Size	Stud Hole Size (In.)	Figure Dimensions (In.)				PANDUIT® Color Code	PANDUIT® Die Index No. ‡	Wire Strip Length (In.)	Std. Pkg. Qty.
	Class G, H, I, K, M	Locomotive			W	B	T	L				
LCAX3/0-10F-X	3/0 AWG	3/0 AWG	3/0 AWG	#10	1.06	.91	.14	1.51	Orange	P50	1	10
LCAX3/0-14F-X				1/4	1.06	.91	.14	1.75	Orange	P50	1	10
LCAX3/0-56F-X				5/16	1.06	.91	.14	1.77	Orange	P50	1	10
LCAX3/0-38F-X				3/8	1.06	.91	.14	1.84	Orange	P50	1	10
LCAX3/0-12F-X				1/2	1.06	.91	.14	2.07	Orange	P50	1	10
LCAX4/0-14F-X	4/0 AWG	4/0 AWG	4/0 AWG	1/4	1.19	1.03	.16	1.84	Purple	P54	1 1/16	10
LCAX4/0-56F-X				5/16	1.19	1.03	.16	2.07	Purple	P54	1 1/16	10
LCAX4/0-38F-X				3/8	1.19	1.03	.16	2.07	Purple	P54	1 1/16	10
LCAX4/0-12F-X				1/2	1.19	1.03	.16	2.18	Purple	P54	1 1/16	10
LCAX4/0-58F-X				5/8	1.19	1.03	.16	2.39	Purple	P54	1 1/16	10
LCAX4/0-34F-X				3/4	1.19	1.03	.16	2.58	Purple	P54	1 1/16	10
LCAX250-14F-X	250 kcmil	262.6 kcmil	—	1/4	1.28	1.03	.17	1.90	Yellow	P62	1 1/16	10
LCAX250-56F-X				5/16	1.28	1.03	.17	2.13	Yellow	P62	1 1/16	10
LCAX250-38F-X				3/8	1.28	1.03	.17	2.13	Yellow	P62	1 1/16	10
LCAX250-12F-X				1/2	1.28	1.03	.17	2.24	Yellow	P62	1 1/16	10
LCAX250-58F-X				5/8	1.28	1.03	.17	2.45	Yellow	P62	1 1/16	10
LCAX250-34F-X				3/4	1.28	1.03	.17	2.64	Yellow	P62	1 1/16	10
LCAX300-38F-6	300 kcmil	313.1 kcmil	—	3/8	1.39	1.19	.18	2.37	Red	P71	1 1/4	6
LCAX300-12F-6				1/2	1.39	1.19	.18	2.37	Red	P71	1 1/4	6
LCAX300-58F-6				5/8	1.39	1.19	.18	2.58	Red	P71	1 1/4	6
LCAX350-56F-6	350 kcmil	373.7 kcmil	—	5/16	1.54	1.29	.22	2.32	Blue	P76	1 3/8	6
LCAX350-38F-6				3/8	1.54	1.29	.22	2.32	Blue	P76	1 3/8	6
LCAX350-12F-6				1/2	1.54	1.29	.22	2.48	Blue	P76	1 3/8	6
LCAX350-58F-6				5/8	1.54	1.29	.22	2.69	Blue	P76	1 3/8	6
LCAX450-12F-6	450 kcmil	444.4 kcmil	—	1/2	1.70	1.40	.26	2.95	Brown	P87	1 7/16	6
LCAX450-58F-6				5/8	1.70	1.40	.26	3.08	Brown	P87	1 7/16	6
LCAX500-56F-6	500 kcmil	535.3 kcmil	—	5/16	1.89	1.48	.26	2.44	Pink	P99	1 9/16	6
LCAX500-38F-6				3/8	1.89	1.48	.26	2.44	Pink	P99	1 9/16	6
LCAX500-12F-6				1/2	1.89	1.48	.26	2.81	Pink	P99	1 9/16	6
LCAX500-58F-6				5/8	1.89	1.48	.26	3.37	Pink	P99	1 9/16	6
LCAX650-56F-6	—	646.4 kcmil	—	5/16	1.95	1.45	.30	2.50	Black	P106	1 1/2	6
LCAX650-38F-6				3/8	1.95	1.45	.30	2.50	Black	P106	1 1/2	6
LCAX650-12F-6				1/2	1.95	1.45	.30	2.86	Black	P106	1 1/2	6
LCAX650-58F-6				5/8	1.95	1.45	.30	3.42	Black	P106	1 1/2	6
LCAX750-12F-3	—	777.7 kcmil	—	1/2	2.17	1.66	.32	2.86	Yellow	P115	1 3/4	3
LCAX750-58F-3				5/8	2.17	1.66	.32	3.67	Yellow	P115	1 3/4	3

‡See [pages L22, L23](#) in Technical Info section for tool and die information.

**Consult cable manufacturer for voltage stress relief instructions with applications greater than 2000 volts.

System Overview

Terminals

Disconnects

Splices

Ferrules

Compression Connectors

Crimping Tools

Mechanical Connectors

Grounding Connectors

Support Products

Technical Info

Index

System Overview

NEW!



Flex Conductor, One-Hole, Standard Barrel with Window, Narrow Tongue Lug

Terminals

For Use with Flexible, Extra-Flexible and Code Stranded Copper Conductors
Type LCAXN

Disconnects

- Narrow tongue width for limited space applications
- Can be used with flex conductor class: G, H, I, K, M and Locomotive
- Generously beveled wire entry prevents bent back strands when inserting conductor into barrel
- Color coded barrels marked with **PANDUIT®** and specified competitor die index numbers for proper crimp die selection
- Inspection window to visually assure full conductor insertion
- Tin plated to inhibit corrosion
- UL Listed for use up to 35KV**, temperature rated 90°C and CSA Certified to 600V when crimped with **PANDUIT®** and specified competitor crimping tools and dies

Splices

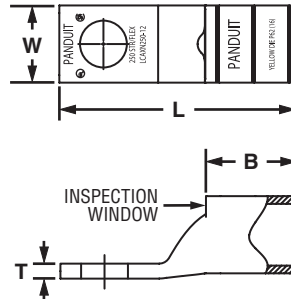

Ferrules

Compression Connectors

Part Number	Flex Conductor Size		Stud Hole Size (In.)	Figure Dimensions (In.)				PANDUIT® Color Code	PANDUIT® Die Index No. ‡	Wire Strip Length (In.)	Std. Pkg. Qty.
	Class G, H, I, K, M	Locomotive		W	B	T	L				
LCAXN250-12-X	250 kcmil	262.6 kcmil	1/2	.88	1.03	.17	2.68	Yellow	P62	1 1/16	10

Crimping Tools

‡See [pages L22, L23](#) in Technical Info section for tool and die information.
 **Consult cable manufacturer for voltage stress relief instructions with applications greater than 2000 volts.

Mechanical Connectors

Grounding Connectors

Support Products

Technical Info

Index

NEW!



Flex, One-Hole, Standard Barrel with Window, Narrow Tongue Lug, 45°

For Use with Flexible, Extra-Flexible and Code Stranded Copper Conductors

Type LCAXN-H

- Narrow tongue width for limited space applications
- Can be used with flex conductor class: G, H, I, K, M and Locomotive
- Generously beveled wire entry prevents bent back strands when inserting conductor into barrel
- Color coded barrels marked with *PANDUIT®* and specified competitor die index numbers for proper crimp die selection
- Inspection window to visually assure full conductor insertion
- Tin plated to inhibit corrosion
- UL Listed for use up to 35KV**, temperature rated 90°C and CSA Certified to 600V when crimped with *PANDUIT®* and specified competitor crimping tools and dies

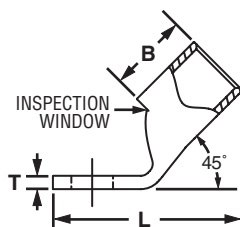

Part Number	Flex Conductor Size		Stud Hole Size (In.)	Figure Dimensions (In.)				PANDUIT® Color Code	PANDUIT® Die Index No.‡	Wire Strip Length (In.)	Std. Pkg. Qty.
	Class G, H, I, K, M	Locomotive		W	B	T	L				
LCAXN250-12H-X	250 kcmil	262.6 kcmil	1/2	.88	1.03	.17	2.41	Yellow	P62	1 1/16	10

‡See [pages L22, L23](#) in Technical Info section for tool and die information.

**Consult cable manufacturer for voltage stress relief instructions with applications greater than 2000 volts.

System Overview

Terminals

Disconnects

Splices

Ferrules

Compression Connectors

Crimping Tools

Mechanical Connectors

Grounding Connectors

Support Products

Technical Info

Index

System Overview

NEW! Flex, One-Hole, Standard Barrel with Window, Narrow Tongue Lug, 90°

For Use with Flexible, Extra-Flexible and Code Stranded Copper Conductors

Terminals

Type LCAXN-F

- Narrow tongue width for limited space applications
- Can be used with flex conductor class: G, H, I, K, M and Locomotive
- Inspection window to visually assure full conductor insertion
- Tin plated to inhibit corrosion
- UL Listed for use up to 35KV**, temperature rated 90°C and CSA Certified to 600V when crimped with PANDUIT® and specified competitor crimping tools and dies
- Generously beveled wire entry prevents bent back strands when inserting conductor into barrel
- Color coded barrels marked with PANDUIT® and specified competitor die index numbers for proper crimp die selection

Disconnects

Splices

Ferrules

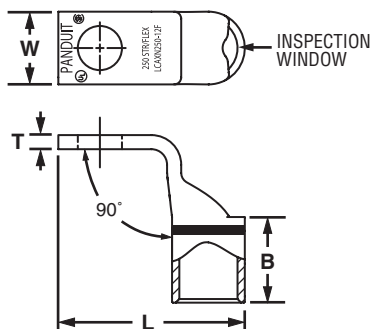

Compression Connectors

Part Number	Flex Conductor Size		Stud Hole Size (In.)	Figure Dimensions (In.)				PANDUIT® Color Code	PANDUIT® Die Index No.‡	Wire Strip Length (In.)	Std. Pkg. Qty.
	Class G, H, I, K, M	Locomotive		W	B	T	L				
LCAXN250-12F-X	250 kcmil	262.6 kcmil	1/2	.88	1.03	.17	2.24	Yellow	P62	1 1/16	10

Crimping Tools

‡See pages L22, L23 in Technical Info section for tool and die information.
 **Consult cable manufacturer for voltage stress relief instructions with applications greater than 2000 volts.

Mechanical Connectors

Grounding Connectors

Support Products

Technical Info

Index



Flex Conductor, One-Hole, Standard Barrel with Window, Flared Lug

For Use with Flexible and Extra-Flexible Copper Conductors

Type LCAF

- Can be used with flex conductor class: K, M and Locomotive
- Flared entry prevents bent back strands when inserting fine strand conductor into barrel
- Color coded barrels marked with PANDUIT® die index numbers for proper crimp die selection
- Inspection window to visually assure full conductor insertion
- Tin plated to inhibit corrosion
- UL Listed for use up to 35KV** and temperature rated 90°C and CSA Certified to 600V when crimped with PANDUIT® crimping tools and dies
- Tested by Telcordia — meets NEBS Level 3

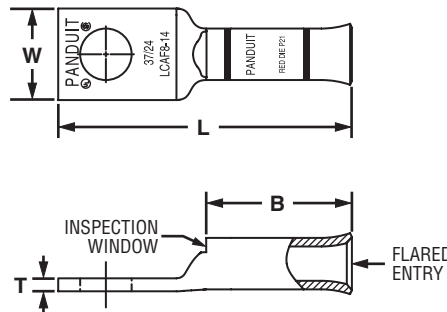

Part Number	Flex Conductor Size		Stud Hole Size (In.)	Figure Dimensions (In.)				PANDUIT® Color Code	PANDUIT® Die Index No.‡	Wire Strip Length (In.)	Std. Pkg. Qty.
	Class K & M	Locomotive		W	B	T	L				
LCAF8-10-L	—	#8 AWG	#10	.41	.76	.08	1.45	Red	P21	13/16	50
LCAF8-14-L			1/4	.48	.76	.07	1.54	Red	P21	13/16	50
LCAF8-56-L			5/16	.56	.76	.05	1.66	Red	P21	13/16	50
LCAF8-38-L			3/8	.60	.76	.05	1.76	Red	P21	13/16	50
LCAF6-10-L	#6 AWG	#6 AWG	#10	.45	.81	.09	1.52	Blue	P24	7/8	50
LCAF6-14-L			1/4	.48	.81	.08	1.61	Blue	P24	7/8	50
LCAF6-56-L			5/16	.56	.81	.07	1.73	Blue	P24	7/8	50
LCAF6-38-L			3/8	.62	.81	.06	1.83	Blue	P24	7/8	50
LCAF4-10-L	#4 AWG	#4 AWG	#10	.55	.81	.09	1.54	Gray	P29	7/8	50
LCAF4-14-L			1/4	.55	.81	.09	1.63	Gray	P29	7/8	50
LCAF4-56-L			5/16	.55	.81	.09	1.75	Gray	P29	7/8	50
LCAF4-38-L			3/8	.62	.81	.07	1.85	Gray	P29	7/8	50
LCAF2-14-E	#2 AWG	#2 AWG	1/4	.70	.88	.11	1.79	Brown	P33	15/16	20
LCAF2-56-E			5/16	.70	.88	.11	1.92	Brown	P33	15/16	20
LCAF2-38-E			3/8	.70	.88	.11	1.99	Brown	P33	15/16	20
LCAF2-12-E			1/2	.79	.88	.09	2.23	Brown	P33	15/16	20
LCAF1-14-X	#1 AWG	#1 AWG	1/4	.76	.94	.12	1.95	Pink	P42	1	10
LCAF1-56-X			5/16	.76	.94	.12	2.00	Pink	P42	1	10
LCAF1-38-X			3/8	.76	.94	.12	2.08	Pink	P42	1	10
LCAF1-12-X			1/2	.80	.94	.12	2.31	Pink	P42	1	10
LCAF1/0-14-X	1/0 AWG	1/0 AWG	1/4	.85	1.35	.13	2.46	Black	P45	1 7/16	10
LCAF1/0-56-X			5/16	.85	1.35	.13	2.46	Black	P45	1 7/16	10
LCAF1/0-38-X			3/8	.85	1.35	.13	2.52	Black	P45	1 7/16	10
LCAF1/0-12-X			1/2	.85	1.35	.13	2.77	Black	P45	1 7/16	10
LCAF2/0-14-X	2/0 AWG	2/0 AWG	1/4	.96	1.35	.13	2.49	Orange	P50	1 7/16	10
LCAF2/0-56-X			5/16	.96	1.35	.13	2.49	Orange	P50	1 7/16	10
LCAF2/0-38-X			3/8	.96	1.35	.13	2.55	Orange	P50	1 7/16	10
LCAF2/0-12-X			1/2	.96	1.35	.13	2.80	Orange	P50	1 7/16	10
LCAF3/0-14-X	3/0 AWG	3/0 AWG	1/4	1.06	1.35	.14	2.52	Purple	P54	1 7/16	10
LCAF3/0-56-X			5/16	1.06	1.35	.14	2.53	Purple	P54	1 7/16	10
LCAF3/0-38-X			3/8	1.06	1.35	.14	2.60	Purple	P54	1 7/16	10
LCAF3/0-12-X			1/2	1.06	1.35	.14	2.83	Purple	P54	1 7/16	10

Chart continues on page F74

System Overview



Flex Conductor, One-Hole, Standard Barrel with Window, Flared Lug (continued)

Terminals

Disconnects

Splices

Ferrules

Compression Connectors

Crimping Tools

Mechanical Connectors

Grounding Connectors

Support Products

Technical Info

Index

Part Number	Flex Conductor Size		Stud Hole Size (In.)	Figure Dimensions (In.)				PANDUIT® Color Code	PANDUIT® Die Index No.‡	Wire Strip Length (In.)	Std. Pkg. Qty.
	Class K & M	Locomotive		W	B	T	L				
LCAF4/0-14-X	4/0 AWG	4/0 AWG	1/4	1.17	1.35	.14	2.56	Yellow	P62	1 7/16	10
LCAF4/0-56-X			5/16	1.17	1.35	.14	2.58	Yellow	P62	1 7/16	10
LCAF4/0-38-X			3/8	1.17	1.35	.14	2.65	Yellow	P62	1 7/16	10
LCAF4/0-12-X			1/2	1.17	1.35	.14	2.88	Yellow	P62	1 7/16	10
LCAF250-38-X	250 kcmil	262.6 kcmil	3/8	1.28	1.65	.17	3.19	White	P66	1 3/4	10
LCAF250-12-X			1/2	1.28	1.65	.17	3.30	White	P66	1 3/4	10
LCAF250-58-X			5/8	1.28	1.65	.17	3.51	White	P66	1 3/4	10
LCAF250-78-X			7/8	1.28	1.65	.17	3.95	White	P66	1 3/4	10
LCAF300-38-6	300 kcmil	313.1 kcmil	3/8	1.39	1.65	.18	3.37	Red	P71	1 3/4	6
LCAF300-12-6			1/2	1.39	1.65	.18	3.37	Red	P71	1 3/4	6
LCAF300-58-6			5/8	1.39	1.65	.18	3.58	Red	P71	1 3/4	6
LCAF300-78-6			7/8	1.39	1.65	.18	3.97	Red	P71	1 3/4	6
LCAF350-38-6	350 kcmil	373.7 kcmil	3/8	1.54	1.85	.22	3.49	Blue	P76	1 15/16	6
LCAF350-12-6			1/2	1.54	1.85	.22	3.65	Blue	P76	1 15/16	6
LCAF350-58-6			5/8	1.54	1.85	.22	3.86	Blue	P76	1 15/16	6
LCAF350-34-6			3/4	1.54	1.85	.22	4.00	Blue	P76	1 15/16	6
LCAF350-78-6			7/8	1.54	1.85	.22	4.25	Blue	P76	1 15/16	6
LCAF350-1-6			1	1.54	1.85	.22	4.37	Blue	P76	1 15/16	6
LCAF400-12-6	400 kcmil	444.4 kcmil	1/2	1.70	2.20	.26	4.65	Brown	P87	2 1/4	6
LCAF400-58-6			5/8	1.70	2.20	.26	4.65	Brown	P87	2 1/4	6
LCAF400-78-6			7/8	1.70	2.20	.26	4.65	Brown	P87	2 1/4	6
LCAF500-12-6	500 kcmil	535.3 kcmil	1/2	1.89	2.28	.26	4.99	Pink	P99	2 5/16	6
LCAF500-58-6			5/8	1.89	2.28	.26	5.18	Pink	P99	2 5/16	6
LCAF600-12-6	—	646.4 kcmil	1/2	1.95	2.33	.30	5.07	Black	P106	2 3/8	6
LCAF600-58-6			5/8	1.95	2.33	.30	5.26	Black	P106	2 3/8	6
LCAF750-12-3	—	777.7 kcmil	1/2	2.17	2.38	.32	5.21	Orange	P107	2 7/16	3
LCAF750-58-3			5/8	2.17	2.38	.32	5.40	Orange	P107	2 7/16	3

‡See [pages L24, L25](#) in Technical Info section for tool and die information.

**Consult cable manufacturer for voltage stress relief instructions with applications greater than 2000 volts.



Flex, One-Hole, Standard Barrel with Window, Flared Lug, 45° Angle

For Use with Flexible and Extra-Flexible Copper Conductors

Type LCAF-H

- Can be used with flex conductor class: K, M and Locomotive
- Flared entry prevents bent back strands when inserting fine strand conductor into barrel
- Color coded barrels marked with PANDUIT® die index numbers for proper crimp die selection
- Inspection window to visually assure full conductor insertion
- Tin plated to inhibit corrosion
- UL Listed for use up to 35KV** and temperature rated 90°C and CSA Certified to 600V when crimped with PANDUIT® crimping tools and dies
- Tested by Telcordia — meets NEBS Level 3

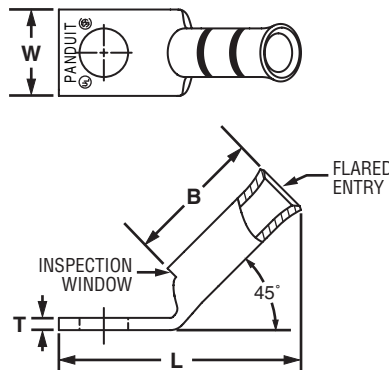

Part Number	Flex Conductor Size		Stud Hole Size (In.)	Figure Dimensions (In.)				PANDUIT® Color Code	PANDUIT® Die Index No.‡	Wire Strip Length (In.)	Std. Pkg. Qty.
	Class K & M	Locomotive		W	B	T	L				
LCAF8-10H-L	—	#8 AWG	#10	.41	.76	.08	1.26	Red	P21	13/16	50
LCAF8-14H-L			1/4	.48	.76	.07	1.35	Red	P21	13/16	50
LCAF8-56H-L			5/16	.56	.76	.05	1.46	Red	P21	13/16	50
LCAF8-38H-L			3/8	.60	.76	.05	1.55	Red	P21	13/16	50
LCAF6-10H-L	#6 AWG	#6 AWG	#10	.45	.81	.09	1.31	Blue	P24	7/8	50
LCAF6-14H-L			1/4	.48	.81	.08	1.40	Blue	P24	7/8	50
LCAF6-56H-L			5/16	.56	.81	.07	1.51	Blue	P24	7/8	50
LCAF6-38H-L			3/8	.62	.81	.06	1.61	Blue	P24	7/8	50
LCAF4-10H-L	#4 AWG	#4 AWG	#10	.55	.81	.09	1.34	Gray	P29	7/8	50
LCAF4-14H-L			1/4	.55	.81	.09	1.43	Gray	P29	7/8	50
LCAF4-56H-L			5/16	.55	.81	.09	1.55	Gray	P29	7/8	50
LCAF4-38H-L			3/8	.62	.81	.07	1.64	Gray	P29	7/8	50
LCAF2-14H-E	#2 AWG	#2 AWG	1/4	.70	.88	.11	1.52	Brown	P33	15/16	20
LCAF2-56H-E			5/16	.70	.88	.11	1.65	Brown	P33	15/16	20
LCAF2-38H-E			3/8	.70	.88	.11	1.72	Brown	P33	15/16	20
LCAF2-12H-E			1/2	.79	.88	.09	1.95	Brown	P33	15/16	20
LCAF1-14H-X	#1 AWG	#1 AWG	1/4	.76	.94	.12	1.65	Pink	P42	1	10
LCAF1-56H-X			5/16	.76	.94	.12	1.71	Pink	P42	1	10
LCAF1-38H-X			3/8	.76	.94	.12	1.78	Pink	P42	1	10
LCAF1-12H-X			1/2	.80	.94	.12	2.01	Pink	P42	1	10
LCAF1/0-14H-X	1/0 AWG	1/0 AWG	1/4	.85	1.35	.13	2.06	Black	P45	1 7/16	10
LCAF1/0-56H-X			5/16	.85	1.35	.13	2.06	Black	P45	1 7/16	10
LCAF1/0-38H-X			3/8	.85	1.35	.13	2.12	Black	P45	1 7/16	10
LCAF1/0-12H-X			1/2	.85	1.35	.13	2.37	Black	P45	1 7/16	10
LCAF2/0-14H-X	2/0 AWG	2/0 AWG	1/4	.96	1.35	.13	2.08	Orange	P50	1 7/16	10
LCAF2/0-56H-X			5/16	.96	1.35	.13	2.08	Orange	P50	1 7/16	10
LCAF2/0-38H-X			3/8	.98	1.35	.13	2.14	Orange	P50	1 7/16	10
LCAF2/0-12H-X			1/2	.96	1.35	.13	2.39	Orange	P50	1 7/16	10

Chart continues on page F76

System Overview



Flex, One-Hole, Standard Barrel with Window, Flared Lug, 45° Angle (continued)

Terminals

Part Number	Flex Conductor Size		Stud Hole Size (In.)	Figure Dimensions (In.)				PANDUIT® Color Code	PANDUIT® Die Index No.‡	Wire Strip Length (In.)	Std. Pkg. Qty.
	Class K & M	Locomotive		W	B	T	L				
LCAF3/0-14H-X	3/0 AWG	3/0 AWG	1/4	1.06	1.35	.14	2.11	Purple	P54	1 7/16	10
LCAF3/0-56H-X			5/16	1.06	1.35	.14	2.13	Purple	P54	1 7/16	10
LCAF3/0-38H-X			3/8	1.06	1.35	.14	2.20	Purple	P54	1 7/16	10
LCAF3/0-12H-X			1/2	1.06	1.35	.14	2.43	Purple	P54	1 7/16	10
LCAF4/0-14H-X	4/0 AWG	4/0 AWG	1/4	1.17	1.35	.14	2.16	Yellow	P62	1 7/16	10
LCAF4/0-56H-X			5/16	1.17	1.35	.14	2.17	Yellow	P62	1 7/16	10
LCAF4/0-38H-X			3/8	1.17	1.35	.14	2.24	Yellow	P62	1 7/16	10
LCAF4/0-12H-X			1/2	1.17	1.35	.14	2.47	Yellow	P62	1 7/16	10
LCAF250-38H-X	250 kcmil	262.6 kcmil	3/8	1.28	1.65	.17	3.19	White	P66	1 3/4	10
LCAF250-12H-X			1/2	1.28	1.65	.17	2.89	White	P66	1 3/4	10
LCAF250-58H-X			5/8	1.28	1.65	.17	3.10	White	P66	1 3/4	10
LCAF250-78H-X			7/8	1.28	1.65	.17	3.54	White	P66	1 3/4	10
LCAF300-38H-6	300 kcmil	313.1 kcmil	3/8	1.39	1.64	.18	3.00	Red	P71	1 3/4	6
LCAF300-12H-6			1/2	1.39	1.64	.18	3.00	Red	P71	1 3/4	6
LCAF300-58H-6			5/8	1.39	1.64	.18	3.21	Red	P71	1 3/4	6
LCAF300-78H-6			7/8	1.39	1.64	.18	3.60	Red	P71	1 3/4	6
LCAF350-38H-6	350 kcmil	373.7 kcmil	3/8	1.54	1.84	.22	3.06	Blue	P76	1 15/16	6
LCAF350-12H-6			1/2	1.54	1.84	.22	3.22	Blue	P76	1 15/16	6
LCAF350-58H-6			5/8	1.54	1.84	.22	3.43	Blue	P76	1 15/16	6
LCAF350-34H-6			3/4	1.54	1.84	.22	3.57	Blue	P76	1 15/16	6
LCAF350-78H-6			7/8	1.54	1.84	.22	3.82	Blue	P76	1 15/16	6
LCAF350-1H-6			1	1.54	1.84	.22	3.94	Blue	P76	1 15/16	6
LCAF400-12H-6	400 kcmil	444.4 kcmil	1/2	1.70	2.19	.26	4.12	Brown	P87	2 1/4	6
LCAF400-58H-6			5/8	1.70	2.19	.26	4.12	Brown	P87	2 1/4	6
LCAF400-78H-6			7/8	1.70	2.19	.26	4.12	Brown	P87	2 1/4	6

‡See [pages L24, L25](#) in Technical Info section for tool and die information.

**Consult cable manufacturer for voltage stress relief instructions with applications greater than 2000 volts.

Mechanical Connectors

Grounding Connectors

Support Products

Technical Info

Index

PANDUIT® TERMINATION SOLUTIONS



Flex, One-Hole, Standard Barrel with Window, Flared Lug, 90° Angle

For Use with Flexible and Extra-Flexible Copper Conductors

Type LCAF-F

- Can be used with flex conductor class: K, M and Locomotive
- Flared entry prevents bent back strands when inserting fine strand conductor into barrel
- Color coded barrels marked with PANDUIT® die index numbers for proper crimp die selection
- Inspection window to visually assure full conductor insertion
- Tin plated to inhibit corrosion
- UL Listed for use up to 35KV** and temperature rated 90°C and CSA Certified to 600V when crimped with PANDUIT® crimping tools and dies
- Tested by Telcordia — meets NEBS Level 3

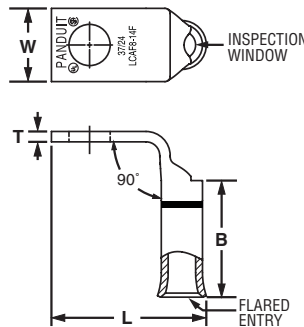

Part Number	Flex Conductor Size		Stud Hole Size (In.)	Figure Dimensions (In.)				PANDUIT® Color Code	PANDUIT® Die Index No.‡	Wire Strip Length (In.)	Std. Pkg. Qty.
	Class K & M	Locomotive		W	B	T	L				
LCAF8-10F-L	—	#8 AWG	#10	.41	.76	.08	.93	Red	P21	13/16	50
LCAF8-14F-L			1/4	.48	.76	.07	1.02	Red	P21	13/16	50
LCAF8-56F-L			5/16	.56	.76	.05	1.14	Red	P21	13/16	50
LCAF8-38F-L			3/8	.60	.76	.05	1.24	Red	P21	13/16	50
LCAF6-10F-L	#6 AWG	#6 AWG	#10	.45	.81	.09	1.52	Blue	P24	7/8	50
LCAF6-14F-L			1/4	.48	.81	.08	1.06	Blue	P24	7/8	50
LCAF6-56F-L			5/16	.56	.81	.07	1.18	Blue	P24	7/8	50
LCAF6-38F-L			3/8	.62	.81	.06	1.28	Blue	P24	7/8	50
LCAF4-10F-L	#4 AWG	#4 AWG	#10	.55	.81	.09	1.07	Gray	P29	7/8	50
LCAF4-14F-L			1/4	.55	.81	.09	1.16	Gray	P29	7/8	50
LCAF4-56F-L			5/16	.55	.81	.09	1.28	Gray	P29	7/8	50
LCAF4-38F-L			3/8	.62	.81	.07	1.38	Gray	P29	7/8	50
LCAF2-14F-E	#2 AWG	#2 AWG	1/4	.70	.88	.11	1.35	Brown	P33	15/16	20
LCAF2-56F-E			5/16	.70	.88	.11	1.48	Brown	P33	15/16	20
LCAF2-38F-E			3/8	.70	.88	.11	1.55	Brown	P33	15/16	20
LCAF2-12F-E			1/2	.79	.88	.09	1.79	Brown	P33	15/16	20
LCAF1-14F-X	#1 AWG	#1 AWG	1/4	.76	.94	.12	1.49	Pink	P42	1	10
LCAF1-56F-X			5/16	.76	.94	.12	1.54	Pink	P42	1	10
LCAF1-38F-X			3/8	.76	.94	.12	1.62	Pink	P42	1	10
LCAF1-12F-X			1/2	.80	.94	.12	1.85	Pink	P42	1	10
LCAF1/0-14F-X	1/0 AWG	1/0 AWG	1/4	.85	1.35	.13	1.64	Black	P45	1 7/16	10
LCAF1/0-56F-X			5/16	.85	1.35	.13	1.70	Black	P45	1 7/16	10
LCAF1/0-38F-X			3/8	.85	1.35	.13	1.70	Black	P45	1 7/16	10
LCAF1/0-12F-X			1/2	.85	1.35	.13	1.95	Black	P45	1 7/16	10
LCAF2/0-14F-X	2/0 AWG	2/0 AWG	1/4	.96	1.35	.13	1.71	Orange	P50	1 7/16	10
LCAF2/0-56F-X			5/16	.96	1.35	.13	1.71	Orange	P50	1 7/16	10
LCAF2/0-38F-X			3/8	.96	1.35	.13	1.77	Orange	P50	1 7/16	10
LCAF2/0-12F-X			1/2	.96	1.35	.13	2.02	Orange	P50	1 7/16	10
LCAF3/0-14F-X	3/0 AWG	3/0 AWG	1/4	1.06	1.35	.14	1.81	Purple	P54	1 7/16	10
LCAF3/0-56F-X			5/16	1.06	1.35	.14	1.82	Purple	P54	1 7/16	10
LCAF3/0-38F-X			3/8	1.06	1.35	.14	1.89	Purple	P54	1 7/16	10
LCAF3/0-12F-X			1/2	1.06	1.35	.14	2.12	Purple	P54	1 7/16	10

Chart continues on page F78

System Overview



Flex, One-Hole, Standard Barrel with Window, Flared Lug, 90° Angle (continued)

Terminals

Disconnects

Splices

Ferrules

Compression Connectors

Crimping Tools

Mechanical Connectors

Grounding Connectors

Support Products

Technical Info

Index

Part Number	Flex Conductor Size		Stud Hole Size (In.)	Figure Dimensions (In.)				PANDUIT® Color Code	PANDUIT® Die Index No.‡	Wire Strip Length (In.)	Std. Pkg. Qty.
	Class K & M	Locomotive		W	B	T	L				
LCAF4/0-14F-X	4/0 AWG	4/0 AWG	1/4	1.17	1.35	.14	1.88	Yellow	P62	1 7/16	10
LCAF4/0-56F-X			5/16	1.17	1.35	.14	1.90	Yellow	P62	1 7/16	10
LCAF4/0-38F-X			3/8	1.17	1.35	.14	1.97	Yellow	P62	1 7/16	10
LCAF4/0-12F-X			1/2	1.17	1.35	.14	2.20	Yellow	P62	1 7/16	10
LCAF250-38F-X	250 kcmil	262.6 kcmil	3/8	1.28	.65	.17	2.21	White	P66	1 3/4	10
LCAF250-12F-X			1/2	1.28	1.65	.17	2.32	White	P66	1 3/4	10
LCAF250-58F-X			5/8	1.28	1.65	.17	2.53	White	P66	1 3/4	10
LCAF250-78F-X			7/8	1.28	1.65	.17	2.97	White	P66	1 3/4	10
LCAF300-38F-6	300 kcmil	313.1 kcmil	3/8	1.39	1.65	.18	2.44	Red	P71	1 3/4	6
LCAF300-12F-6			1/2	1.39	1.65	.18	2.44	Red	P71	1 3/4	6
LCAF300-58F-6			5/8	1.39	1.65	.18	2.65	Red	P71	1 3/4	6
LCAF300-78F-6			7/8	1.39	1.65	.18	3.04	Red	P71	1 3/4	6
LCAF350-38F-6	350 kcmil	373.7 kcmil	3/8	1.54	1.85	.22	2.40	Blue	P76	1 15/16	6
LCAF350-12F-6			1/2	1.54	1.85	.22	2.40	Blue	P76	1 15/16	6
LCAF350-58F-6			5/8	1.54	1.85	.22	2.77	Blue	P76	1 15/16	6
LCAF350-34F-6			3/4	1.54	1.85	.22	2.91	Blue	P76	1 15/16	6
LCAF350-78F-6			7/8	1.54	1.85	.22	3.16	Blue	P76	1 15/16	6
LCAF350-1F-6			1	1.54	1.85	.22	3.28	Blue	P76	1 15/16	6
LCAF400-12F-6	400 kcmil	444.4 kcmil	1/2	1.70	2.20	.26	3.28	Brown	P87	2 1/4	6
LCAF400-58F-6			5/8	1.70	2.20	.26	3.28	Brown	P87	2 1/4	6
LCAF400-78F-6			7/8	1.70	2.20	.26	3.28	Brown	P87	2 1/4	6

‡See [pages L24, L25](#) in Technical Info section for tool and die information.

**Consult cable manufacturer for voltage stress relief instructions with applications greater than 2000 volts.

NEW!



Flex Conductor, One-Hole, Long Barrel with Window Lug

For Use with Flexible, Extra-Flexible and Code Stranded Copper Conductors

Type LCBX

- Can be used with code conductor and flex conductor class: G, H, I, K, M and Locomotive
- Long barrel maximizes number of crimps and provides premium wire pull-out strength and electrical performance
- Generously beveled wire entry prevents bent back strands when inserting conductor into barrel
- Color coded barrels marked with **PANDUIT®** and specified competitor die index numbers for proper crimp die selection
- Inspection window to visually assure full conductor insertion
- Tin plated to inhibit corrosion
- UL Listed for use up to 35KV**, temperature rated 90°C and CSA Certified to 600V when crimped with **PANDUIT®** and specified competitor crimping tools and dies
- Meets TIA-607 requirements for network systems grounding applications

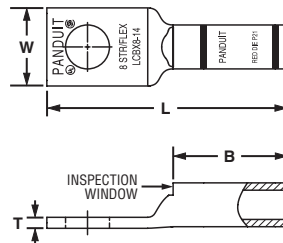

Part Number	Flex Conductor Size		Code Conductor Size	Stud Hole Size (In.)	Figure Dimensions (In.)				PANDUIT® Color Code	PANDUIT® Die Index No.‡	Wire Strip Length (In.)	Std. Pkg. Qty.
	Class G, H, I, K, M	Locomotive			W	B	T	L				
LCBX8-10-L				#10	.41	.70	.08	1.39	Red	P21	3/4	50
LCBX8-14-L	#8 AWG	#8 AWG	#8 AWG	1/4	.48	.70	.07	1.48	Red	P21	3/4	50
LCBX8-38-L				3/8	.60	.70	.05	1.70	Red	P21	3/4	50
LCBX6-14-L	#6 AWG	#6 AWG	#6 AWG	1/4	.48	1.07	.08	1.86	Blue	P24	1 1/8	50
LCBX6-38-L				3/8	.62	1.07	.06	2.08	Blue	P24	1 1/8	50
LCBX4-14-L	#4 AWG	#5, #4, #3 AWG	#4 – #3 AWG STR, #2 AWG SOL	1/4	.55	1.05	.09	1.87	Gray	P29	1 1/8	50
LCBX4-38-L				3/8	.62	1.05	.07	2.09	Gray	P29	1 1/8	50
LCBX2-14-E	#2 AWG	#2 AWG	#2 AWG	1/4	.70	1.36	.11	2.26	Brown	P33	1 7/16	20
LCBX2-38-E				3/8	.70	1.36	.11	2.46	Brown	P33	1 7/16	20
LCBX2-12-E				1/2	.75	1.36	.09	2.70	Brown	P33	1 7/16	20
LCBX1-14-X	#1 AWG	#1 AWG	#1 AWG	1/4	.76	1.44	.12	2.44	Green	P37	1 1/2	10
LCBX1-56-X				5/16	.76	1.44	.12	2.50	Green	P37	1 1/2	10
LCBX1-38-X				3/8	.76	1.44	.12	2.57	Green	P37	1 1/2	10
LCBX1/0-14-X	1/0 AWG	1/0 AWG	1/0 AWG	1/4	.85	1.50	.13	2.61	Pink	P42	1 9/16	10
LCBX1/0-38-X				3/8	.85	1.50	.13	2.67	Pink	P42	1 9/16	10
LCBX1/0-12-X				1/2	.85	1.50	.13	2.92	Pink	P42	1 9/16	10
LCBX2/0-14-X	2/0 AWG	2/0 AWG	2/0 AWG	1/4	.96	1.50	.13	2.64	Black	P45	1 9/16	10
LCBX2/0-38-X				3/8	.96	1.50	.13	2.70	Black	P45	1 9/16	10
LCBX2/0-12-X				1/2	.96	1.50	.13	2.96	Black	P45	1 9/16	10
LCBX3/0-38-X	3/0 AWG	3/0 AWG	3/0 AWG	3/8	1.06	1.56	.14	2.81	Orange	P50	1 5/8	10
LCBX4/0-38-X	4/0 AWG	4/0 AWG	4/0 AWG	3/8	1.19	2.24	.16	3.74	Purple	P54	2 5/16	10
LCBX4/0-12-X				1/2	1.19	2.24	.16	3.85	Purple	P54	2 5/16	10
LCBX250-38-X	250 kcmil	262.6 kcmil	—	3/8	1.28	2.24	.17	3.78	Yellow	P62	2 5/16	10
LCBX300-38-6	300 kcmil	313.1 kcmil	—	3/8	1.39	2.30	.18	4.02	Red	P71	2 3/8	6
LCBX350-38-6	350 kcmil	373.7 kcmil	—	3/8	1.54	2.50	.22	4.14	Blue	P76	2 9/16	6
LCBX350-12-6				1/2	1.54	2.50	.22	4.30	Blue	P76	2 9/16	6
LCBX450-38-6	450 kcmil	444.4 kcmil	—	3/8	1.70	2.69	.26	5.14	Brown	P87	2 3/4	6
LCBX500-38-6	500 kcmil	535.3 kcmil	—	3/8	1.89	2.88	.26	4.84	Pink	P99	2 15/16	6
LCBX500-12-6				1/2	1.89	2.88	.26	5.03	Pink	P99	2 15/16	6

‡See [pages L22, L23](#) in Technical Info section for tool and die information.

**Consult cable manufacturer for voltage stress relief instructions with applications greater than 2000 volts.

System Overview

Terminals

Disconnects

Splices

Ferrules

Compression Connectors

Crimping Tools

Mechanical Connectors

Grounding Connectors

Support Products

Technical Info

Index

PANDUIT® TERMINATION SOLUTIONS

System Overview

NEW!



Flex Conductor, One-Hole, Long Barrel with Window Lug, 45° Angle

Terminals

For Use with Flexible, Extra-Flexible and Code Stranded Copper Conductors

Type LCBX-H

- Can be used with code conductor and flex conductor class: G, H, I, K, M and Locomotive
- Long barrel maximizes number of crimps and provides premium wire pull-out strength and electrical performance
- Generously beveled wire entry prevents bent back strands when inserting conductor into barrel
- Color coded barrels marked with **PANDUIT®** and specified competitor die index numbers for proper crimp die selection
- Inspection window to visually assure full conductor insertion
- Tin plated to inhibit corrosion
- UL Listed for use up to 35KV**, temperature rated 90°C and CSA Certified to 600V when crimped with **PANDUIT®** and specified competitor crimping tools and dies
- Meets TIA-607 requirements for network systems grounding applications

Disconnects

Splices

Ferrules

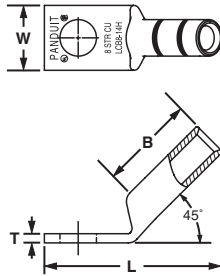

Compression Connectors

Crimping Tools

Mechanical Connectors

Grounding Connectors

Support Products

Technical Info

Index

Part Number	Flex Conductor Size		Code Conductor Size	Stud Hole Size (In.)	Figure Dimensions (In.)				PANDUIT® Color Code	PANDUIT® Die Index No.‡	Wire Strip Length (In.)	Std. Pkg. Qty.
	Class G, H, I, K, M	Locomotive			W	B	T	L				
LCBX8-10H-L				#10	.41	.70	.08	1.20	Red	P21	3/4	50
LCBX8-14H-L	#8 AWG	#8 AWG	#8 AWG	1/4	.48	.70	.07	1.28	Red	P21	3/4	50
LCBX8-38H-L				3/8	.60	.70	.05	1.49	Red	P21	3/4	50
LCBX6-14H-L	#6 AWG	#6 AWG	#6 AWG	1/4	.48	1.07	.08	1.56	Blue	P24	1 1/8	50
LCBX6-38H-L				3/8	.62	1.07	.06	1.77	Blue	P24	1 1/8	50
LCBX4-14H-L	#4 AWG	#5, #4, #3 AWG	#4 – #3 AWG STR, #2 AWG SOL	1/4	.55	1.05	.09	1.57	Gray	P29	1 1/8	50
LCBX4-38H-L				3/8	.62	1.05	.07	1.78	Gray	P29	1 1/8	50
LCBX2-14H-E	#2 AWG	#2 AWG	#2 AWG	1/4	.70	1.36	.11	1.83	Brown	P33	1 7/16	20
LCBX2-38H-E				3/8	.70	1.36	.11	2.03	Brown	P33	1 7/16	20
LCBX2-12H-E				1/2	.75	1.36	.09	2.26	Brown	P33	1 7/16	20
LCBX1-14H-X	#1 AWG	#1 AWG	#1 AWG	1/4	.76	1.44	.12	1.98	Green	P37	1 1/2	10
LCBX1-56H-X				5/16	.76	1.44	.12	2.04	Green	P37	1 1/2	10
LCBX1-38H-X				3/8	.76	1.44	.12	2.11	Green	P37	1 1/2	10
LCBX1/0-14H-X	1/0 AWG	1/0 AWG	1/0 AWG	1/4	.85	1.50	.13	2.13	Pink	P42	1 9/16	10
LCBX1/0-38H-X				3/8	.85	1.50	.13	2.20	Pink	P42	1 9/16	10
LCBX1/0-12H-X				1/2	.85	1.50	.13	2.45	Pink	P42	1 9/16	10
LCBX2/0-14H-X	2/0 AWG	2/0 AWG	2/0 AWG	1/4	.96	1.50	.13	2.16	Black	P45	1 9/16	10
LCBX2/0-38H-X				3/8	.96	1.50	.13	2.22	Black	P45	1 9/16	10
LCBX2/0-12H-X				1/2	.96	1.50	.13	2.47	Black	P45	1 9/16	10
LCBX3/0-38H-X	3/0 AWG	3/0 AWG	3/0 AWG	3/8	1.06	1.56	.14	2.31	Orange	P50	1 5/8	10
LCBX4/0-38H-X	4/0 AWG	4/0 AWG	4/0 AWG	3/8	1.19	2.24	.16	3.12	Purple	P54	2 5/16	10
LCBX4/0-12H-X				1/2	1.19	2.24	.16	3.23	Purple	P54	2 5/16	10
LCBX250-38H-X	250 kcmil	262.6 kcmil	—	3/8	1.28	2.24	.17	3.15	Yellow	P62	2 5/16	10
LCBX300-38H-6	300 kcmil	313.1 kcmil	—	3/8	1.39	2.30	.18	3.42	Red	P71	2 3/8	6
LCBX300-12H-6				1/2	1.39	2.30	.18	3.69	Red	P71	2 3/8	6
LCBX350-38H-6	350 kcmil	373.7 kcmil	—	3/8	1.54	2.50	.22	3.48	Blue	P76	2 9/16	6
LCBX350-12H-6				1/2	1.54	2.50	.22	3.64	Blue	P76	2 9/16	6
LCBX450-38H-6	450 kcmil	444.4 kcmil	—	3/8	1.70	2.69	.26	4.42	Brown	P87	2 3/4	6
LCBX500-38H-6	500 kcmil	535.3 kcmil	—	3/8	1.89	2.88	.26	4.08	Pink	P99	2 15/16	6
LCBX500-12H-6				1/2	1.89	2.88	.26	4.27	Pink	P99	2 15/16	6

‡See [pages L22, L23](#) in Technical Info section for tool and die information.

**Consult cable manufacturer for voltage stress relief instructions with applications greater than 2000 volts.

NEW!



Flex Conductor, One-Hole, Long Barrel with Window Lug, 90° Angle

For Use with Flexible, Extra-Flexible and Code Stranded Copper Conductors

Type LCBX-F

- Can be used with code conductor and flex conductor class: G, H, I, K, M and Locomotive
- Long barrel maximizes number of crimps and provides premium wire pull-out strength and electrical performance
- Generously beveled wire entry prevents bent back strands when inserting conductor into barrel
- Color coded barrels marked with **PANDUIT®** and specified competitor die index numbers for proper crimp die selection
- Inspection window to visually assure full conductor insertion
- Tin plated to inhibit corrosion
- UL Listed for use up to 35KV**, temperature rated 90°C and CSA Certified to 600V when crimped with **PANDUIT®** and specified competitor crimping tools and dies
- Meets TIA-607 requirements for network systems grounding applications

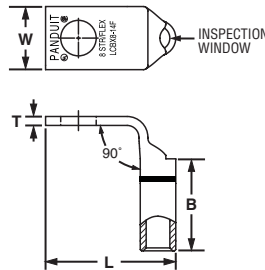

Part Number	Flex Conductor Size		Code Conductor Size	Stud Hole Size (In.)	Figure Dimensions (In.)				PANDUIT® Color Code	PANDUIT® Die Index No.‡	Wire Strip Length (In.)	Std. Pkg. Qty.
	Class G, H, I, K, M	Locomotive			W	B	T	L				
LCBX8-10F-L	#8 AWG	#8 AWG	#8 AWG	#10	.41	.70	.08	.90	Red	P21	3/4	50
LCBX8-14F-L				1/4	.48	.70	.07	.99	Red	P21	3/4	50
LCBX8-38F-L				3/8	.60	.70	.05	1.21	Red	P21	3/4	50
LCBX6-14F-L	#6 AWG	#6 AWG	#6 AWG	1/4	.48	1.07	.08	1.03	Blue	P24	1 1/8	50
LCBX6-38F-L				3/8	.62	1.07	.06	1.25	Blue	P24	1 1/8	50
LCBX4-14F-L	#4 AWG	#5, #4, #3 AWG	#4 – #3 AWG STR, #2 AWG SOL	1/4	.55	1.05	.09	1.12	Gray	P29	1 1/8	50
LCBX4-38F-L				3/8	.62	1.05	.07	1.34	Gray	P29	1 1/8	50
LCBX2-14F-E	#2 AWG	#2 AWG	#2 AWG	1/4	.70	1.36	.11	1.31	Brown	P33	1 7/16	20
LCBX2-38F-E				3/8	.70	1.36	.11	1.51	Brown	P33	1 7/16	20
LCBX2-12F-E				1/2	.75	1.36	.09	1.75	Brown	P33	1 7/16	20
LCBX1-14F-X	#1 AWG	#1 AWG	#1 AWG	1/4	.76	1.44	.12	1.45	Green	P37	1 1/2	10
LCBX1-56F-X				5/16	.76	1.44	.12	1.51	Green	P37	1 1/2	10
LCBX1-38F-X				3/8	.76	1.44	.12	1.58	Green	P37	1 1/2	10
LCBX1/0-14F-X	1/0 AWG	1/0 AWG	1/0 AWG	1/4	.85	1.50	.13	1.61	Pink	P42	1 9/16	10
LCBX1/0-38F-X				3/8	.85	1.50	.13	1.66	Pink	P42	1 9/16	10
LCBX1/0-12F-X				1/2	.85	1.50	.13	1.91	Pink	P42	1 9/16	10
LCBX2/0-14F-X	2/0 AWG	2/0 AWG	2/0 AWG	1/4	.96	1.50	.13	1.67	Black	P45	1 9/16	10
LCBX2/0-38F-X				3/8	.96	1.50	.13	1.73	Black	P45	1 9/16	10
LCBX2/0-12F-X				1/2	.96	1.50	.13	1.98	Black	P45	1 9/16	10
LCBX3/0-38F-X	3/0 AWG	3/0 AWG	3/0 AWG	3/8	1.06	1.56	.14	1.84	Orange	P50	1 5/8	10
LCBX4/0-38F-X	4/0 AWG	4/0 AWG	4/0 AWG	3/8	1.19	2.24	.16	2.07	Purple	P54	2 5/16	10
LCBX4/0-12F-X				1/2	1.19	2.24	.16	2.18	Purple	P54	2 5/16	10
LCBX250-38F-X	250 kcmil	262.6 kcmil	—	3/8	1.28	2.24	.17	2.13	Yellow	P62	2 5/16	10
LCBX300-38F-6	300 kcmil	313.1 kcmil	—	3/8	1.39	2.30	.18	2.37	Red	P71	2 3/8	6
LCBX300-12F-6				1/2	1.39	2.30	.18	2.37	Red	P71	2 3/8	6
LCBX350-38F-6	350 kcmil	373.7 kcmil	—	3/8	1.54	2.50	.22	2.32	Blue	P76	2 9/16	6
LCBX350-12F-6				1/2	1.54	2.50	.22	2.48	Blue	P76	2 9/16	6
LCBX450-38F-6	450 kcmil	444.4 kcmil	—	3/8	1.70	2.69	.26	3.14	Brown	P87	2 3/4	6
LCBX500-38F-6	500 kcmil	535.3 kcmil	—	3/8	1.89	2.88	.26	2.62	Pink	P99	2 15/16	6
LCBX500-12F-6				1/2	1.89	2.88	.26	2.81	Pink	P99	2 15/16	6

‡See pages L22, L23 in Technical Info section for tool and die information.

**Consult cable manufacturer for voltage stress relief instructions with applications greater than 2000 volts.

System Overview

Terminals

Disconnects

Splices

Ferrules

Compression Connectors

Crimping Tools

Mechanical Connectors

Grounding Connectors

Support Products

Technical Info

Index

PANDUIT® TERMINATION SOLUTIONS

System Overview

NEW!



Flex Conductor, Two-Hole, Standard Barrel with Window Lug

Terminals

For Use with Flexible, Extra-Flexible and Code Stranded Copper Conductors

Type LCDX

- Can be used with code conductor and flex conductor class: G, H, I, K, M and Locomotive
- Generously beveled wire entry prevents bent back strands when inserting conductor into barrel
- Color coded barrels marked with **PANDUIT®** and specified competitor die index numbers for proper crimp die selection
- Inspection window to visually assure full conductor insertion
- Tin plated to inhibit corrosion
- UL Listed for use up to 35KV**, temperature rated 90°C and CSA Certified to 600V when crimped with **PANDUIT®** and specified competitor crimping tools and dies
- Available with NEMA hole sizes and spacing

Disconnects

Splices

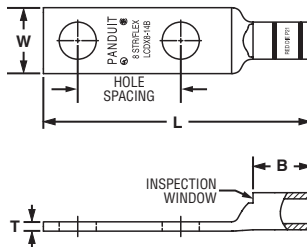

Ferrules

Compression Connectors

Crimping Tools

Mechanical Connectors

Grounding Connectors

Support Products

Technical Info

Index

Part Number	Flex Conductor Size		Code Conductor Size	Stud Hole Size (In.)	Stud Hole Spacing (In.)	Figure Dimensions (In.)				PANDUIT® Color Code	PANDUIT® Die Index No.‡	Wire Strip Length (In.)	Std. Pkg. Qty.
	Class G, H, I, K, M	Locomotive				W	B	T	L				
LCDX8-10A-L	#8 AWG	#8 AWG	#8 AWG	#10	.63	.41	.42	.08	1.74	Red	P21	1/2	50
LCDX8-14A-L				1/4	.63	.48	.42	.07	1.83	Red	P21	1/2	50
LCDX8-14B-L				1/4	.75	.48	.42	.07	1.95	Red	P21	1/2	50
LCDX8-14D-L				1/4	1.00	.48	.42	.07	2.20	Red	P21	1/2	50
LCDX8-38D-L				3/8	1.00	.60	.42	.05	2.42	Red	P21	1/2	50
LCDX6-10A-L	#6 AWG	#6 AWG	#6 AWG	#10	.63	.46	.48	.08	1.82	Blue	P24	9/16	50
LCDX6-10B-L				#10	.75	.46	.48	.08	1.94	Blue	P24	9/16	50
LCDX6-10G-L				#10	1.50	.46	.48	.08	2.69	Blue	P24	9/16	50
LCDX6-10P-L				#10	.69	.46	.48	.08	1.88	Blue	P24	9/16	50
LCDX6-14A-L				1/4	.63	.48	.48	.08	1.91	Blue	P24	9/16	50
LCDX6-14B-L	1/4	.75	.48	.48	.08	2.03	Blue	P24	9/16	50			
LCDX6-14D-L	1/4	1.00	.48	.48	.08	2.28	Blue	P24	9/16	50			
LCDX6-56D-L	#4 AWG	#5, #4, #3 AWG	#4 AWG	5/16	1.00	.56	.48	.07	2.40	Blue	P24	9/16	50
LCDX6-38D-L				3/8	1.00	.62	.48	.06	2.50	Blue	P24	9/16	50
LCDX4-14A-L				1/4	.63	.55	.53	.09	1.98	Gray	P29	5/8	50
LCDX4-14B-L	1/4	.75	.55	.53	.09	2.10	Gray	P29	5/8	50			
LCDX4-14D-L	1/4	1.00	.55	.53	.09	2.35	Gray	P29	5/8	50			
LCDX4-56D-L	5/16	1.00	.55	.53	.09	2.47	Gray	P29	5/8	50			
LCDX4-38D-L	3/8	1.00	.62	.53	.08	2.57	Gray	P29	5/8	50			
LCDX2-14A-E	#2 AWG	#2 AWG	#2 AWG	1/4	.63	.70	.59	.11	2.13	Brown	P33	11/16	20
LCDX2-14B-E				1/4	.75	.70	.59	.11	2.25	Brown	P33	11/16	20
LCDX2-14D-E				1/4	1.00	.70	.59	.11	2.50	Brown	P33	11/16	20
LCDX2-56D-E				5/16	1.00	.70	.59	.11	2.63	Brown	P33	11/16	20
LCDX2-38D-E				3/8	1.00	.70	.59	.11	2.70	Brown	P33	11/16	20
LCDX2-12-E	1/2	1.75	.75	.59	.09	3.87	Brown	P33	11/16	20			
LCDX1-14A-X	#1 AWG	#1 AWG	#1 AWG	1/4	.63	.76	.66	.12	2.29	Green	P37	3/4	10
LCDX1-14B-X				1/4	.75	.76	.66	.12	2.42	Green	P37	3/4	10
LCDX1-14D-X				1/4	1.00	.76	.66	.12	2.67	Green	P37	3/4	10
LCDX1-56D-X				5/16	1.00	.76	.66	.12	2.72	Green	P37	3/4	10
LCDX1-38D-X				3/8	1.00	.76	.66	.12	2.80	Green	P37	3/4	10
LCDX1-12-X	1/2	1.75	.80	.66	.12	3.97	Green	P37	3/4	10			

PANDUIT® TERMINATION SOLUTIONS



Flex Conductor, Two-Hole, Standard Barrel with Window Lug (continued)

Part Number	Flex Conductor Size		Code Conductor Size	Stud Hole Size (In.)	Stud Hole Spacing (In.)	Figure Dimensions (In.)				PANDUIT® Color Code	PANDUIT® Die Index No.‡	Wire Strip Length (In.)	Std. Pkg. Qty.
	Class G, H, I, K, M	Locomotive				W	B	T	L				
LCDX1/0-14A-X	1/0 AWG	1/0 AWG	1/0 AWG	1/4	.63	.85	.72	.13	2.45	Pink	P42	3/4	10
LCDX1/0-14B-X				1/4	.75	.85	.72	.13	2.57	Pink	P42	3/4	10
LCDX1/0-56B-X				5/16	.75	.85	.72	.13	2.57	Pink	P42	3/4	10
LCDX1/0-56D-X				5/16	1.00	.85	.72	.13	2.82	Pink	P42	3/4	10
LCDX1/0-38D-X				3/8	1.00	.85	.72	.13	2.89	Pink	P42	3/4	10
LCDX1/0-12D-X				1/2	1.00	.85	.72	.13	3.14	Pink	P42	3/4	10
LCDX1/0-12-X	1/2	1.75	.85	.72	.13	4.05	Pink	P42	3/4	10			
LCDX2/0-14A-X	2/0 AWG	2/0 AWG	2/0 AWG	1/4	.63	.96	.83	.13	2.59	Black	P45	7/8	10
LCDX2/0-14B-X				1/4	.75	.96	.83	.13	2.72	Black	P45	7/8	10
LCDX2/0-56D-X				5/16	1.00	.96	.83	.13	2.97	Black	P45	7/8	10
LCDX2/0-38D-X				3/8	1.00	.96	.83	.13	3.03	Black	P45	7/8	10
LCDX2/0-12D-X				1/2	1.00	.96	.83	.13	3.28	Black	P45	7/8	10
LCDX2/0-12-X				1/2	1.75	.96	.83	.13	4.19	Black	P45	7/8	10
LCDX3/0-14A-X	3/0 AWG	3/0 AWG	3/0 AWG	1/4	.63	1.06	.91	.14	2.71	Orange	P50	1	10
LCDX3/0-56D-X				5/16	1.00	1.06	.91	.14	3.10	Orange	P50	1	10
LCDX3/0-38D-X				3/8	1.00	1.06	.91	.14	3.17	Orange	P50	1	10
LCDX3/0-12-X				1/2	1.75	1.06	.91	.14	4.31	Orange	P50	1	10
LCDX4/0-14A-X	4/0 AWG	4/0 AWG	4/0 AWG	1/4	.63	1.19	1.03	.16	2.74	Purple	P54	1 1/16	10
LCDX4/0-14B-X				1/4	.75	1.19	1.03	.16	2.86	Purple	P54	1 1/16	10
LCDX4/0-56D-X				5/16	1.00	1.19	1.03	.16	3.31	Purple	P54	1 1/16	10
LCDX4/0-38D-X				3/8	1.00	1.19	1.03	.16	3.34	Purple	P54	1 1/16	10
LCDX4/0-12D-X				1/2	1.00	1.19	1.03	.16	3.61	Purple	P54	1 1/16	10
LCDX4/0-12E-X				1/2	1.25	1.19	1.03	.16	3.89	Purple	P54	1 1/16	10
LCDX4/0-12-X	1/2	1.75	1.19	1.03	.16	4.52	Purple	P54	1 1/16	10			
LCDX250-38D-X	250 kcmil	262.6 kcmil	—	3/8	1.00	1.28	1.03	.17	3.38	Yellow	P62	1 1/16	10
LCDX250-38-X				3/8	1.75	1.28	1.03	.17	4.13	Yellow	P62	1 1/16	10
LCDX250-12E-X				1/2	1.25	1.28	1.03	.17	3.93	Yellow	P62	1 1/16	10
LCDX250-12-X				1/2	1.75	1.28	1.03	.17	4.56	Yellow	P62	1 1/16	10
LCDX300-38D-6	300 kcmil	313.1 kcmil	—	3/8	1.00	1.39	1.19	.18	3.56	Red	P71	1 1/4	6
LCDX300-12-6				1/2	1.75	1.39	1.19	.18	4.74	Red	P71	1 1/4	6
LCDX350-56D-6	350 kcmil	373.7 kcmil	—	5/16	1.00	1.54	1.29	.22	3.71	Blue	P76	1 3/8	6
LCDX350-38D-6				3/8	1.00	1.54	1.29	.22	3.74	Blue	P76	1 3/8	6
LCDX350-38-6				3/8	1.75	1.54	1.29	.22	4.49	Blue	P76	1 3/8	6
LCDX350-12E-6				1/2	1.25	1.54	1.29	.22	4.29	Blue	P76	1 3/8	6
LCDX350-12-6	1/2	1.75	1.54	1.29	.22	4.92	Blue	P76	1 3/8	6			
LCDX450-38D-6	450 kcmil	444.4 kcmil	—	3/8	1.00	1.70	1.40	.26	3.90	Brown	P87	1 7/16	6
LCDX450-12-6				1/2	1.75	1.70	1.40	.26	5.08	Brown	P87	1 7/16	6
LCDX500-56D-6	500 kcmil	535.3 kcmil	—	5/16	1.00	1.89	1.48	.26	4.05	Pink	P99	1 9/16	6
LCDX500-38D-6				3/8	1.00	1.89	1.48	.26	4.08	Pink	P99	1 9/16	6
LCDX500-12E-6				1/2	1.25	1.89	1.48	.26	4.76	Pink	P99	1 9/16	6
LCDX500-12-6				1/2	1.75	1.89	1.48	.26	5.26	Pink	P99	1 9/16	6
LCDX600-12-6	600 kcmil	—	—	1/2	1.75	1.89	1.48	.26	5.26	Pink	P99	1 9/16	6
LCDX650-38D-6	—	646.4 kcmil	—	3/8	1.00	1.95	1.45	.30	4.08	Black	P106	1 1/2	6
LCDX650-12-6				1/2	1.75	1.95	1.45	.30	5.26	Black	P106	1 1/2	6
LCDX750-38D-3	—	777.7 kcmil	—	3/8	1.00	2.17	1.66	.32	4.62	Yellow	P115	1 3/4	3
LCDX750-12E-3				1/2	1.25	2.17	1.66	.32	5.06	Yellow	P115	1 3/4	3
LCDX750-12G-3				1/2	1.50	2.17	1.66	.32	5.31	Yellow	P115	1 3/4	3
LCDX750-12-3				1/2	1.75	2.17	1.66	.32	5.56	Yellow	P115	1 3/4	3
LCDX750-58G-3				5/8	1.50	2.17	1.66	.32	5.37	Yellow	P115	1 3/4	3

‡See [pages L22, L23](#) in Technical Info section for tool and die information.

**Consult cable manufacturer for voltage stress relief instructions with applications greater than 2000 volts.

◆NEMA hole sizes and spacing.

System Overview

Terminals

Disconnects

Splices

Ferrules

Compression Connectors

Crimping Tools

Mechanical Connectors

Grounding Connectors

Support Products

Technical Info

Index

System Overview

NEW!



Flex Conductor, Two-Hole, Standard Barrel with Window Lug, 45° Angle

Terminals

For Use with Flexible, Extra-Flexible and Code Stranded Copper Conductors

Type LCDX-H

- Can be used with code conductor and flex conductor class: G, H, I, K, M and Locomotive
- Generously beveled wire entry prevents bent back strands when inserting conductor into barrel
- Color coded barrels marked with **PANDUIT®** and specified competitor die index numbers for proper crimp die selection
- Inspection window to visually assure full conductor insertion
- Tin plated to inhibit corrosion
- UL Listed for use up to 35KV**, temperature rated 90°C and CSA Certified to 600V when crimped with **PANDUIT®** and specified competitor crimping tools and dies
- Available with NEMA hole sizes and spacing

Disconnects

Splices

Ferrules

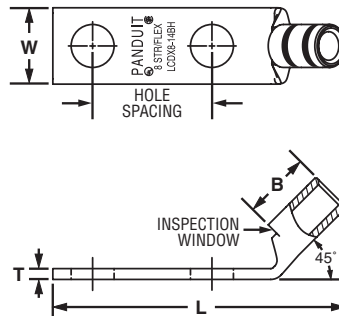

Compression Connectors

Crimping Tools

Mechanical Connectors

Grounding Connectors

Support Products

Technical Info

Index

Part Number	Flex Conductor Size		Code Conductor Size	Stud Hole Size (In.)	Stud Hole Spacing (In.)	Figure Dimensions (In.)				PANDUIT® Color Code	PANDUIT® Die Index No.‡	Wire Strip Length (In.)	Std. Pkg. Qty.
	Class G, H, I, K, M	Locomotive				W	B	T	L				
LCDX8-10AH-L				#10	.63	.41	.42	.08	1.63	Red	P21	1/2	50
LCDX8-14AH-L				1/4	.63	.48	.42	.07	1.71	Red	P21	1/2	50
LCDX8-14BH-L	#8 AWG	#8 AWG	#8 AWG	1/4	.75	.48	.42	.07	1.84	Red	P21	1/2	50
LCDX8-14DH-L				1/4	1.00	.48	.42	.07	2.09	Red	P21	1/2	50
LCDX8-38DH-L				3/8	1.00	.60	.42	.05	2.30	Red	P21	1/2	50
LCDX6-10AH-L				#10	.63	.46	.48	.08	1.68	Blue	P24	9/16	50
LCDX6-10BH-L				#10	.75	.46	.48	.08	1.81	Blue	P24	9/16	50
LCDX6-10GH-L				#10	1.50	.46	.48	.08	2.56	Blue	P24	9/16	50
LCDX6-10PH-L				#10	.69	.46	.48	.08	1.74	Blue	P24	9/16	50
LCDX6-14AH-L	#6 AWG	#6 AWG	#6 AWG	1/4	.63	.48	.48	.08	1.77	Blue	P24	9/16	50
LCDX6-14BH-L				1/4	.75	.48	.48	.08	1.89	Blue	P24	9/16	50
LCDX6-14DH-L				1/4	1.00	.48	.48	.08	2.14	Blue	P24	9/16	50
LCDX6-56DH-L				5/16	1.00	.56	.48	.07	2.26	Blue	P24	9/16	50
LCDX6-38DH-L				3/8	1.00	.62	.48	.06	2.35	Blue	P24	9/16	50
LCDX4-14AH-L				1/4	.63	.55	.53	.09	1.83	Gray	P29	5/8	50
LCDX4-14BH-L				1/4	.75	.55	.53	.09	1.96	Gray	P29	5/8	50
LCDX4-14DH-L	#4 AWG	#5, #4, #3 AWG	#4 AWG	1/4	1.00	.55	.53	.09	2.21	Gray	P29	5/8	50
LCDX4-56DH-L				5/16	1.00	.55	.53	.09	2.33	Gray	P29	5/8	50
LCDX4-38DH-L				3/8	1.00	.62	.53	.08	2.42	Gray	P29	5/8	50
LCDX2-14AH-E				1/4	.63	.70	.59	.11	1.92	Brown	P33	11/16	20
LCDX2-14BH-E				1/4	.75	.70	.59	.11	2.04	Brown	P33	11/16	20
LCDX2-14DH-E	#2 AWG	#2 AWG	#2 AWG	1/4	1.00	.70	.59	.11	2.29	Brown	P33	11/16	20
LCDX2-56DH-E				5/16	1.00	.70	.59	.11	2.42	Brown	P33	11/16	20
LCDX2-38DH-E				3/8	1.00	.70	.59	.11	2.49	Brown	P33	11/16	20
LCDX2-12H-E				1/2	1.75	.75	.59	.09	3.66	Brown	P33	11/16	20
LCDX1-14AH-X				1/4	.63	.76	.66	.12	2.06	Green	P37	3/4	10
LCDX1-14BH-X				1/4	.75	.76	.66	.12	2.18	Green	P37	3/4	10
LCDX1-14DH-X	#1 AWG	#1 AWG	#1 AWG	1/4	1.00	.76	.66	.12	2.43	Green	P37	3/4	10
LCDX1-56DH-X				5/16	1.00	.76	.66	.12	2.49	Green	P37	3/4	10
LCDX1-38DH-X				3/8	1.00	.76	.66	.12	2.56	Green	P37	3/4	10
LCDX1-12H-X				1/2	1.75	.80	.66	.12	3.73	Green	P37	3/4	10

PANDUIT® TERMINATION SOLUTIONS



Flex Conductor, Two-Hole, Standard Barrel with Window Lug, 45° Angle (continued)

System Overview

Terminals

Disconnects

Splices

Ferrules

Compression Connectors

Crimping Tools

Mechanical Connectors

Grounding Connectors

Support Products

Technical Info

Index

Part Number	Flex Conductor Size		Code Conductor Size	Stud Hole Size (In.)	Stud Hole Spacing (In.)	Figure Dimensions (In.)				PANDUIT® Color Code	PANDUIT® Die Index No.‡	Wire Strip Length (In.)	Std. Pkg. Qty.
	Class G, H, I, K, M	Locomotive				W	B	T	L				
LCDX1/0-14AH-X	1/0 AWG	1/0 AWG	1/0 AWG	1/4	.63	.85	.72	.13	2.21	Pink	P42	3/4	10
LCDX1/0-14BH-X				1/4	.75	.85	.72	.13	2.33	Pink	P42	3/4	10
LCDX1/0-56BH-X				5/16	.75	.85	.72	.13	2.33	Pink	P42	3/4	10
LCDX1/0-56DH-X				5/16	1.00	.85	.72	.13	2.58	Pink	P42	3/4	10
LCDX1/0-38DH-X				3/8	1.00	.85	.72	.13	2.64	Pink	P42	3/4	10
LCDX1/0-12DH-X				1/2	1.00	.85	.72	.13	2.89	Pink	P42	3/4	10
LCDX1/0-12H-X	1/2	1.75	.85	.72	.13	3.81	Pink	P42	3/4	10			
LCDX2/0-14AH-X	2/0 AWG	2/0 AWG	2/0 AWG	1/4	.63	.96	.83	.13	2.30	Black	P45	7/8	10
LCDX2/0-14BH-X				1/4	.75	.96	.83	.13	2.43	Black	P45	7/8	10
LCDX2/0-56DH-X				5/16	1.00	.96	.83	.13	2.68	Black	P45	7/8	10
LCDX2/0-38DH-X				3/8	1.00	.96	.83	.13	2.74	Black	P45	7/8	10
LCDX2/0-12DH-X				1/2	1.00	.96	.83	.13	3.03	Black	P45	7/8	10
LCDX2/0-12H-X				1/2	1.75	.96	.83	.13	3.90	Black	P45	7/8	10
LCDX3/0-14AH-X	3/0 AWG	3/0 AWG	3/0 AWG	1/4	.63	1.06	.91	.14	2.39	Orange	P50	1	10
LCDX3/0-56DH-X				5/16	1.00	1.06	.91	.14	2.78	Orange	P50	1	10
LCDX3/0-38DH-X				3/8	1.00	1.06	.91	.14	2.85	Orange	P50	1	10
LCDX3/0-12H-X				1/2	1.75	1.06	.91	.14	3.99	Orange	P50	1	10
LCDX4/0-14AH-X	4/0 AWG	4/0 AWG	4/0 AWG	1/4	.63	1.19	1.03	.16	2.67	Purple	P54	1 1/16	10
LCDX4/0-14BH-X				1/4	.75	1.19	1.03	.16	2.79	Purple	P54	1 1/16	10
LCDX4/0-56DH-X				5/16	1.00	1.19	1.03	.16	3.04	Purple	P54	1 1/16	10
LCDX4/0-38DH-X				3/8	1.00	1.19	1.03	.16	3.07	Purple	P54	1 1/16	10
LCDX4/0-12DH-X				1/2	1.00	1.19	1.03	.16	3.36	Purple	P54	1 1/16	10
LCDX4/0-12EH-X				1/2	1.25	1.19	1.03	.16	3.62	Purple	P54	1 1/16	10
LCDX4/0-12H-X	1/2	1.75	1.19	1.03	.16	4.25	Purple	P54	1 1/16	10			
LCDX250-38DH-X	250 kcmil	262.6 kcmil	—	3/8	1.00	1.28	1.03	.17	3.11	Yellow	P62	1 1/16	10
LCDX250-38H-X				3/8	1.75	1.28	1.03	.17	3.86	Yellow	P62	1 1/16	10
LCDX250-12EH-X				1/2	1.25	1.28	1.03	.17	3.66	Yellow	P62	1 1/16	10
LCDX250-12H-X				1/2	1.75	1.28	1.03	.17	4.29	Yellow	P62	1 1/16	10
LCDX300-38DH-6	300 kcmil	313.1 kcmil	—	3/8	1.00	1.39	1.19	.18	3.29	Red	P71	1 1/4	6
LCDX300-12H-6				1/2	1.75	1.39	1.19	.18	4.47	Red	P71	1 1/4	6
LCDX350-56DH-6	350 kcmil	373.7 kcmil	—	5/16	1.00	1.55	1.29	.22	3.40	Blue	P76	1 3/8	6
LCDX350-38DH-6				3/8	1.00	1.54	1.29	.22	3.43	Blue	P76	1 3/8	6
LCDX350-38H-6				3/8	1.75	1.54	1.29	.22	4.18	Blue	P76	1 3/8	6
LCDX350-12EH-6				1/2	1.25	1.54	1.29	.22	3.98	Blue	P76	1 3/8	6
LCDX350-12H-6	1/2	1.75	1.54	1.29	.22	4.61	Blue	P76	1 3/8	6			
LCDX450-38DH-6	450 kcmil	444.4 kcmil	—	3/8	1.00	1.70	1.40	.26	3.75	Brown	P87	1 7/16	6
LCDX450-12H-6				1/2	1.75	1.70	1.40	.26	4.74	Brown	P87	1 7/16	6
LCDX500-56DH-6	500 kcmil	535.3 kcmil	—	5/16	1.00	1.89	1.48	.26	3.70	Pink	P99	1 9/16	6
LCDX500-38DH-6				3/8	1.00	1.89	1.48	.26	3.73	Pink	P99	1 9/16	6
LCDX500-12EH-6				1/2	1.25	1.89	1.48	.26	4.41	Pink	P99	1 9/16	6
LCDX500-12H-6				1/2	1.75	1.89	1.48	.26	4.91	Pink	P99	1 9/16	6
LCDX600-12H-6	600 kcmil	—	—	1/2	1.75	1.89	1.48	.26	4.91	Pink	P99	1 9/16	6
LCDX650-38DH-6	—	646.4 kcmil	—	3/8	1.00	1.95	1.45	.30	3.74	Black	P106	1 1/2	6
LCDX650-12H-6				1/2	1.75	1.95	1.45	.30	4.92	Black	P106	1 1/2	6
LCDX750-38DH-3	—	777.7 kcmil	—	3/8	1.00	2.17	1.66	.32	4.21	Yellow	P115	1 3/4	3
LCDX750-12EH-3				1/2	1.25	2.17	1.66	.32	4.65	Yellow	P115	1 3/4	3
LCDX750-12GH-3				1/2	1.50	2.17	1.66	.32	4.90	Yellow	P115	1 3/4	3
LCDX750-12H-3				1/2	1.75	2.17	1.66	.32	5.15	Yellow	P115	1 3/4	3
LCDX750-58GH-3				5/8	1.50	2.17	1.66	.32	4.90	Yellow	P115	1 3/4	3

‡See [pages L22, L23](#) in Technical Info section for tool and die information.
 **Consult cable manufacturer for voltage stress relief instructions with applications greater than 2000 volts.
 ◆NEMA hole sizes and spacing.

System Overview

NEW!



Flex Conductor, Two-Hole, Standard Barrel with Window Lug, 90° Angle

For Use with Flexible, Extra-Flexible and Code Stranded Copper Conductors

Type LCDX-F

- Can be used with code conductor and flex conductor class: G, H, I, K, M and Locomotive
- Generously beveled wire entry prevents bent back strands when inserting conductor into barrel
- Color coded barrels marked with **PANDUIT®** and specified competitor die index numbers for proper crimp die selection
- Inspection window to visually assure full conductor insertion
- Tin plated to inhibit corrosion
- UL Listed for use up to 35KV**, temperature rated 90°C and CSA Certified to 600V when crimped with **PANDUIT®** and specified competitor crimping tools and dies
- Available with NEMA hole sizes and spacing

Terminals

Disconnects

Splices

Ferrules

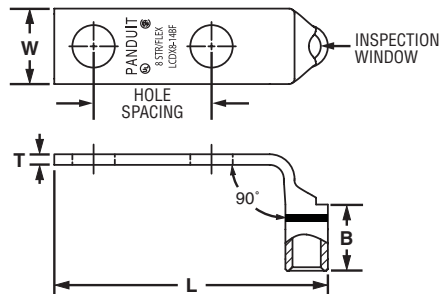

Part Number	Flex Conductor Size		Code Conductor Size	Stud Hole Size (In.)	Stud Hole Spacing (In.)	Figure Dimensions (In.)				PANDUIT® Color Code	PANDUIT® Die Index No.‡	Wire Strip Length (In.)	Std. Pkg. Qty.
	Class G, H, I, K, M	Locomotive				W	B	T	L				
LCDX8-10AF-L	#8 AWG	#8 AWG	#8 AWG	#10	.63	.41	.42	.08	1.53	Red	P21	1/2	50
LCDX8-14AF-L				1/4	.63	.48	.42	.07	1.62	Red	P21	1/2	50
LCDX8-14BF-L				1/4	.75	.48	.42	.07	1.74	Red	P21	1/2	50
LCDX8-14DF-L				1/4	1.00	.48	.42	.07	1.99	Red	P21	1/2	50
LCDX8-38DF-L				3/8	1.00	.63	.42	.05	2.21	Red	P21	1/2	50
LCDX6-10AF-L	#6 AWG	#6 AWG	#6 AWG	#10	.63	.46	.48	.08	1.57	Blue	P24	9/16	50
LCDX6-10BF-L				#10	.75	.46	.48	.08	1.69	Blue	P24	9/16	50
LCDX6-10GF-L				#10	1.50	.46	.48	.08	2.44	Blue	P24	9/16	50
LCDX6-10PF-L				#10	.69	.46	.48	.08	1.63	Blue	P24	9/16	50
LCDX6-14AF-L				1/4	.63	.48	.48	.08	1.66	Blue	P24	9/16	50
LCDX6-14BF-L	1/4	.75	.48	.48	.08	1.78	Blue	P24	9/16	50			
LCDX6-14DF-L	1/4	1.00	.48	.48	.08	2.03	Blue	P24	9/16	50			
LCDX6-56DF-L	5/16	1.00	.56	.48	.07	2.15	Blue	P24	9/16	50			
LCDX6-38DF-L	3/8	1.00	.62	.48	.06	2.25	Blue	P24	9/16	50			
LCDX4-14AF-L	#4 AWG	#5, #4, #3 AWG	#4 AWG	1/4	.63	.55	.53	.09	1.74	Gray	P29	5/8	50
LCDX4-14BF-L				1/4	.75	.55	.53	.09	1.87	Gray	P29	5/8	50
LCDX4-14DF-L				1/4	1.00	.55	.53	.09	2.12	Gray	P29	5/8	50
LCDX4-56DF-L				5/16	1.00	.55	.53	.09	2.24	Gray	P29	5/8	50
LCDX4-38DF-L	3/8	1.00	.62	.53	.08	2.34	Gray	P29	5/8	50			
LCDX2-14AF-E	#2 AWG	#2 AWG	#2 AWG	1/4	.63	.70	.59	.11	1.94	Brown	P33	11/16	20
LCDX2-14BF-E				1/4	.75	.70	.59	.11	2.06	Brown	P33	11/16	20
LCDX2-14DF-E				1/4	1.00	.70	.59	.11	2.31	Brown	P33	11/16	20
LCDX2-56DF-E				5/16	1.00	.70	.59	.11	2.44	Brown	P33	11/16	20
LCDX2-38DF-E				3/8	1.00	.70	.59	.11	2.51	Brown	P33	11/16	20
LCDX2-12F-E	1/2	1.75	.75	.59	.09	3.68	Brown	P33	11/16	20			
LCDX1-14AF-X	#1 AWG	#1 AWG	#1 AWG	1/4	.63	.76	.66	.12	2.08	Green	P37	3/4	10
LCDX1-14BF-X				1/4	.75	.76	.66	.12	2.20	Green	P37	3/4	10
LCDX1-14DF-X				1/4	1.00	.76	.66	.12	2.45	Green	P37	3/4	10
LCDX1-56DF-X				5/16	1.00	.76	.66	.12	2.51	Green	P37	3/4	10
LCDX1-38DF-X				3/8	1.00	.76	.66	.12	2.58	Green	P37	3/4	10
LCDX1-12F-X	1/2	1.75	.80	.66	.12	3.75	Green	P37	3/4	10			

PANDUIT® TERMINATION SOLUTIONS



Flex Conductor, Two-Hole, Standard Barrel with Window Lug, 90° Angle (continued)

Part Number	Flex Conductor Size		Code Conductor Size	Stud Hole Size (In.)	Stud Hole Spacing (In.)	Figure Dimensions (In.)				PANDUIT® Color Code	PANDUIT® Die Index No.‡	Wire Strip Length (In.)	Std. Pkg. Qty.
	Class G, H, I, K, M	Locomotive				W	B	T	L				
LCDX1/0-14AF-X	1/0 AWG	1/0 AWG	1/0 AWG	1/4	.63	.85	.72	.13	2.22	Pink	P42	3/4	10
LCDX1/0-14BF-X				1/4	.75	.85	.72	.13	2.34	Pink	P42	3/4	10
LCDX1/0-56BF-X				5/16	.75	.85	.72	.13	2.34	Pink	P42	3/4	10
LCDX1/0-56DF-X				5/16	1.00	.85	.72	.13	2.59	Pink	P42	3/4	10
LCDX1/0-38DF-X				3/8	1.00	.85	.72	.13	2.66	Pink	P42	3/4	10
LCDX1/0-12DF-X				1/2	1.00	.85	.72	.13	2.91	Pink	P42	3/4	10
LCDX1/0-12F-X				1/2	1.75	.85	.72	.13	3.82	Pink	P42	3/4	10
LCDX2/0-14AF-X	2/0 AWG	2/0 AWG	2/0 AWG	1/4	.63	.96	.83	.13	2.29	Black	P45	7/8	10
LCDX2/0-14BF-X				1/4	.75	.96	.83	.13	2.42	Black	P45	7/8	10
LCDX2/0-56DF-X				5/16	1.00	.96	.83	.13	2.67	Black	P45	7/8	10
LCDX2/0-38DF-X				3/8	1.00	.96	.83	.13	2.73	Black	P45	7/8	10
LCDX2/0-12DF-X				1/2	1.00	.96	.83	.13	2.98	Black	P45	7/8	10
LCDX2/0-12F-X				1/2	1.75	.96	.83	.13	3.89	Black	P45	7/8	10
LCDX3/0-14AF-X				3/0 AWG	3/0 AWG	3/0 AWG	1/4	.63	1.06	.91	.14	2.38	Orange
LCDX3/0-56DF-X	5/16	1.00	1.06				.91	.14	2.77	Orange	P50	1	10
LCDX3/0-38DF-X	3/8	1.00	1.06				.91	.14	2.84	Orange	P50	1	10
LCDX3/0-12F-X	1/2	1.75	1.06				.91	.14	3.98	Orange	P50	1	10
LCDX4/0-14AF-X	4/0 AWG	4/0 AWG	4/0 AWG	1/4	.63	1.19	1.03	.16	2.28	Purple	P54	1 1/16	10
LCDX4/0-14BF-X				1/4	.75	1.19	1.03	.16	2.40	Purple	P54	1 1/16	10
LCDX4/0-56DF-X				5/16	1.00	1.19	1.03	.16	2.85	Purple	P54	1 1/16	10
LCDX4/0-38DF-X				3/8	1.00	1.19	1.03	.16	2.88	Purple	P54	1 1/16	10
LCDX4/0-12DF-X				1/2	1.00	1.19	1.03	.16	3.15	Purple	P54	1 1/16	10
LCDX4/0-12EF-X				1/2	1.25	1.19	1.03	.16	3.43	Purple	P54	1 1/16	10
LCDX4/0-12F-X				1/2	1.75	1.19	1.03	.16	4.06	Purple	P54	1 1/16	10
LCDX250-38DF-X	250 kcmil	262.6 kcmil	—	3/8	1.00	1.28	1.03	.17	2.94	Yellow	P62	1 1/16	10
LCDX250-38F-X				3/8	1.75	1.28	1.03	.17	3.69	Yellow	P62	1 1/16	10
LCDX250-12EF-X				1/2	1.25	1.28	1.03	.17	3.49	Yellow	P62	1 1/16	10
LCDX250-12F-X				1/2	1.75	1.28	1.03	.17	4.12	Yellow	P62	1 1/16	10
LCDX300-38DF-6	300 kcmil	313.1 kcmil	—	3/8	1.00	1.39	1.19	.18	3.02	Red	P71	1 1/4	6
LCDX300-12F-6				1/2	1.75	1.39	1.19	.18	4.20	Red	P71	1 1/4	6
LCDX350-56DF-6	350 kcmil	373.7 kcmil	—	5/16	1.00	1.54	1.29	.22	3.10	Blue	P76	1 3/8	6
LCDX350-38DF-6				3/8	1.00	1.54	1.29	.22	3.13	Blue	P76	1 3/8	6
LCDX350-38F-6				3/8	1.75	1.54	1.29	.22	3.88	Blue	P76	1 3/8	6
LCDX350-12EF-6				1/2	1.25	1.54	1.29	.22	3.68	Blue	P76	1 3/8	6
LCDX350-12F-6				1/2	1.75	1.54	1.29	.22	4.31	Blue	P76	1 3/8	6
LCDX450-38DF-6	450 kcmil	444.4 kcmil	—	3/8	1.00	1.70	1.40	.26	3.26	Brown	P87	1 7/16	6
LCDX450-12F-6				1/2	1.75	1.70	1.40	.26	4.44	Brown	P87	1 7/16	6
LCDX500-56DF-6	500 kcmil	535.3 kcmil	—	5/16	1.00	1.89	1.48	.26	3.29	Pink	P99	1 9/16	6
LCDX500-38DF-6				3/8	1.00	1.89	1.48	.26	3.32	Pink	P99	1 9/16	6
LCDX500-12EF-6				1/2	1.25	1.89	1.48	.26	4.00	Pink	P99	1 9/16	6
LCDX500-12F-6				1/2	1.75	1.89	1.48	.26	4.50	Pink	P99	1 9/16	6
LCDX600-12F-6	600 kcmil	—	—	1/2	1.75	1.89	1.48	.26	4.50	Pink	P99	1 9/16	6
LCDX650-38DF-6	—	646.4 kcmil	—	3/8	1.00	1.95	1.45	.30	3.37	Black	P106	1 1/2	6
LCDX650-12F-6				1/2	1.75	1.95	1.45	.30	4.55	Black	P106	1 1/2	6
LCDX750-38DF-3	—	777.7 kcmil	—	3/8	1.00	2.17	1.66	.32	3.76	Yellow	P115	1 3/4	3
LCDX750-12EF-3				1/2	1.25	2.17	1.66	.32	4.20	Yellow	P115	1 3/4	3
LCDX750-12GF-3				1/2	1.50	2.17	1.66	.32	4.45	Yellow	P115	1 3/4	3
LCDX750-12F-3				1/2	1.75	2.17	1.66	.32	4.70	Yellow	P115	1 3/4	3
LCDX750-58GF-3				5/8	1.50	2.17	1.66	.32	4.45	Yellow	P115	1 3/4	3

‡See pages L22, L23 in Technical Info section for tool and die information.

**Consult cable manufacturer for voltage stress relief instructions with applications greater than 2000 volts.

◆NEMA hole sizes and spacing.

System Overview

Terminals

Disconnects

Splices

Ferrules

Compression Connectors

Crimping Tools

Mechanical Connectors

Grounding Connectors

Support Products

Technical Info

Index

System Overview

NEW!



Flex Conductor, Two-Hole, Standard Barrel with Window, Narrow Tongue Lug

For Use with Flexible, Extra-Flexible and Code Stranded Copper Conductors

Terminals

Type LCDXN

- Narrow tongue width for limited space applications
- Can be used with code conductor and flex conductor class: G, H, I, K, M and Locomotive
- Generously beveled wire entry prevents bent back strands when inserting conductor into barrel
- Color coded barrels marked with **PANDUIT®** and specified competitor die index numbers for proper crimp die selection
- Inspection window to visually assure full conductor insertion
- Tin plated to inhibit corrosion
- UL Listed for use up to 35KV**, temperature rated 90°C and CSA Certified to 600V when crimped with **PANDUIT®** and specified competitor crimping tools and dies
- Available with NEMA hole sizes and spacing

Disconnects

Splices

Ferrules

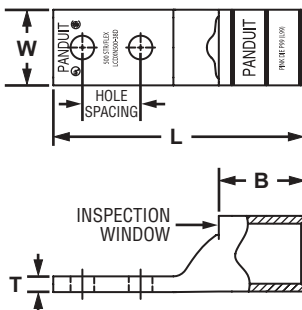

Compression Connectors

Crimping Tools

Mechanical Connectors

Grounding Connectors

Support Products

Technical Info

Index

Part Number	Flex Conductor Size		Code Conductor Size	Stud Hole Size (In.)	Stud Hole Spacing (In.)	Figure Dimensions (In.)				PANDUIT® Color Code	PANDUIT® Die Index No.‡	Wire Strip Length (In.)	Std. Pkg. Qty.
	Class G, H, I, K, M	Locomotive				W	B	T	L				
LCDXN2-14A-E	#2 AWG	#2 AWG	#2 AWG	1/4	.63	.47	.59	.11	2.13	Brown	P33	11/16	20
LCDXN4/0-38D-X	4/0 AWG	4/0 AWG	4/0 AWG	3/8	1.00	.81	1.03	.16	3.34	Purple	P54	1 1/16	10
LCDXN350-38D-6	350 kcmil	373.7 kcmil	—	3/8	1.00	1.06	1.29	.22	3.74	Blue	P76	1 3/8	6
LCDXN500-38D-6	500 kcmil	535.3 kcmil	—	3/8	1.00	1.30	1.48	.27	4.32	Pink	P99	1 9/16	6
LCDXN750-38D-3	—	777.7 kcmil	—	3/8	1.00	1.50	1.66	.32	4.62	Yellow	P115	1 3/4	3
◆ LCDXN750-12-3	—	777.7 kcmil	—	1/2	1.75	1.50	1.66	.32	5.55	Yellow	P115	1 3/4	3

‡See [pages L22, L23](#) in Technical Info section for tool and die information.

**Consult cable manufacturer for voltage stress relief instructions with applications greater than 2000 volts.

◆NEMA hole sizes and spacing.

NEW!



Flex, Two-Hole, Standard Barrel with Window, Narrow Tongue Lug, 45°

For Use with Flexible Copper Conductors

Type LCDXN-H

- Narrow tongue width for limited space applications
- Can be used with locomotive flex conductor
- Generously beveled wire entry prevents bent back strands when inserting conductor into barrel
- Color coded barrels marked with *PANDUIT®* and specified competitor die index numbers for proper crimp die selection
- Inspection window to visually assure full conductor insertion
- Tin plated to inhibit corrosion
- UL Listed for use up to 35KV**, temperature rated 90°C and CSA Certified to 600V when crimped with *PANDUIT®* and specified competitor crimping tools and dies

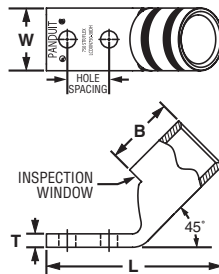

Part Number	Flex Conductor Size		Stud Hole Size (In.)	Stud Hole Spacing (In.)	Figure Dimensions (In.)				PANDUIT® Color Code	PANDUIT® Die Index No. ‡	Wire Strip Length (In.)	Std. Pkg. Qty.
	Class G, H, I, K, M	Locomotive			W	B	T	L				
LCDXN750-38DH-3	—	777.7 kcmil	3/8	1.00	1.50	1.66	.32	4.22	Yellow	P115	1 3/4	3

‡See [pages L22, L23](#) in Technical Info section for tool and die information.

**Consult cable manufacturer for voltage stress relief instructions with applications greater than 2000 volts.

System Overview

Terminals

Disconnects

Splices

Ferrules

Compression Connectors

Crimping Tools

Mechanical Connectors

Grounding Connectors

Support Products

Technical Info

Index

System Overview

NEW!  **Flex, Two-Hole, Standard Barrel with Window, Narrow Tongue Lug, 90°**

For Use with Flexible Copper Conductors

Terminals

Type LCDXN-F

- Narrow tongue width for limited space applications
- Can be used with locomotive flex conductor
- Generously beveled wire entry prevents bent back strands when inserting conductor into barrel
- Color coded barrels marked with **PANDUIT®** and specified competitor die index numbers for proper crimp die selection
- Inspection window to visually assure full conductor insertion
- Tin plated to inhibit corrosion
- UL Listed for use up to 35KV**, temperature rated 90°C and CSA Certified to 600V when crimped with **PANDUIT®** and specified competitor crimping tools and dies

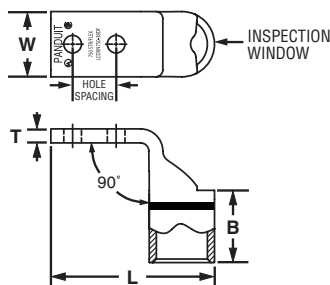
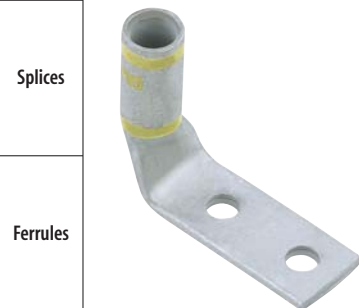

Ferrules

Part Number	Flex Conductor Size		Stud Hole Size (In.)	Stud Hole Spacing (In.)	Figure Dimensions (In.)				PANDUIT® Color Code	PANDUIT® Die Index No. ‡	Wire Strip Length (In.)	Std. Pkg. Qty.
	Class G,H, I, K, M	Locomotive			W	B	T	L				
LCDXN750-38DF-3	—	777.7 kcmil	3/8	1.00	1.50	1.66	.32	3.76	Yellow	P115	1 3/4	3

Compression Connectors

‡See [pages L22, L23](#) in Technical Info section for tool and die information.
 **Consult cable manufacturer for voltage stress relief instructions with applications greater than 2000 volts.

Crimping Tools

Mechanical Connectors

Grounding Connectors

Support Products

Technical Info

Index

NEW!



Flex Conductor, Two-Hole, Long Barrel with Window Lug

For Use with Flexible, Extra-Flexible and Code Stranded Copper Conductors

Type LCCX

- Can be used with code conductor and flex conductor class: G, H, I, K, M and Locomotive
- Long barrel maximizes number of crimps and provides premium wire pull-out strength and electrical performance
- Generously beveled wire entry prevents bent back strands when inserting conductor into barrel
- Color coded barrels marked with **PANDUIT®** and specified competitor die index numbers for proper crimp die selection
- Inspection window to visually assure full conductor insertion
- Tin plated to inhibit corrosion
- UL Listed for use up to 35KV**, temperature rated 90°C and CSA Certified to 600V when crimped with **PANDUIT®** and specified competitor crimping tools and dies
- Meets TIA-607 requirements for network systems grounding applications
- Available with NEMA hole sizes and spacing

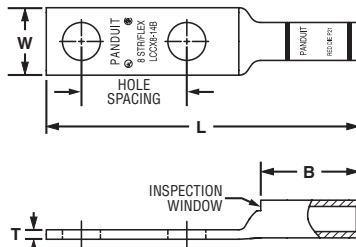

Part Number	Flex Conductor Size		Code Conductor Size	Stud Hole Size (In.)	Stud Hole Spacing (In.)	Figure Dimensions (In.)				PANDUIT® Color Code	PANDUIT® Die Index No. ‡	Wire Strip Length (In.)	Std. Pkg. Qty.
	Class G, H, I, K, M	Locomotive				W	B	T	L				
LCCX8-10A-L	#8 AWG	#8 AWG	#8 AWG	#10	.63	.41	.70	.08	2.01	Red	P21	3/4	50
LCCX8-10B-L				#10	.75	.41	.70	.08	2.14	Red	P21	3/4	50
LCCX8-14A-L				1/4	.63	.48	.70	.07	2.10	Red	P21	3/4	50
LCCX8-14B-L				1/4	.75	.48	.70	.07	2.23	Red	P21	3/4	50
LCCX8-14D-L				1/4	1.00	.48	.70	.07	2.48	Red	P21	3/4	50
LCCX8-38D-L				3/8	1.00	.60	.70	.05	2.70	Red	P21	3/4	50
LCCX6-10B-L	#6 AWG	#6 AWG	#6 AWG	#10	.75	.46	1.07	.08	2.52	Blue	P24	1 1/8	50
LCCX6-14A-L				1/4	.63	.48	1.07	.08	2.49	Blue	P24	1 1/8	50
LCCX6-14B-L				1/4	.75	.48	1.07	.08	2.61	Blue	P24	1 1/8	50
LCCX6-14D-L				1/4	1.00	.48	1.07	.08	2.86	Blue	P24	1 1/8	50
LCCX6-38A-L				3/8	.63	.62	1.07	.06	2.71	Blue	P24	1 1/8	50
LCCX6-38C-L				3/8	.88	.62	1.07	.06	2.96	Blue	P24	1 1/8	50
LCCX6-38D-L	3/8	1.00	.62	1.07	.06	3.08	Blue	P24	1 1/8	50			
LCCX4-14A-L	#4 AWG	#5, #4, #3 AWG	#4 - #3 AWG STR, #2 AWG SOL	1/4	.63	.55	1.05	.09	2.49	Gray	P29	1 1/8	50
LCCX4-14B-L				1/4	.75	.55	1.05	.09	2.63	Gray	P29	1 1/8	50
LCCX4-38B-L				3/8	.75	.62	1.05	.08	2.84	Gray	P29	1 1/8	50
LCCX4-38D-L				3/8	1.00	.62	1.05	.08	3.09	Gray	P29	1 1/8	50
LCCX2-14A-E	#2 AWG	#2 AWG	#2 AWG	1/4	.63	.70	1.36	.11	2.89	Brown	P33	1 7/16	20
LCCX2-14B-E				1/4	.75	.70	1.36	.11	3.01	Brown	P33	1 7/16	20
LCCX2-38D-E				3/8	1.00	.70	1.36	.11	3.46	Brown	P33	1 7/16	20
LCCX2-12-E				1/2	1.75	.75	1.36	.09	4.63	Brown	P33	1 7/16	20
LCCX1-14A-X	#1 AWG	#1 AWG	#1 AWG	1/4	.63	.76	1.44	.12	3.07	Green	P37	1 1/2	10
LCCX1-14B-X				1/4	.75	.76	1.44	.12	3.19	Green	P37	1 1/2	10
LCCX1-14D-X				1/4	1.00	.76	1.44	.12	3.44	Green	P37	1 1/2	10
LCCX1-56C-X				5/16	.88	.76	1.44	.12	3.37	Green	P37	1 1/2	10
LCCX1-56D-X				5/16	1.00	.76	1.44	.12	3.50	Green	P37	1 1/2	10
LCCX1-38D-X				3/8	1.00	.76	1.44	.12	3.57	Green	P37	1 1/2	10
LCCX1/0-14A-X	1/0 AWG	1/0 AWG	1/0 AWG	1/4	.63	.85	1.50	.13	3.23	Pink	P42	1 9/16	10
LCCX1/0-14B-X				1/4	.75	.85	1.50	.13	3.36	Pink	P42	1 9/16	10
LCCX1/0-38D-X				3/8	1.00	.85	1.50	.13	3.67	Pink	P42	1 9/16	10
LCCX1/0-12-X				1/2	1.75	.85	1.50	.13	4.83	Pink	P42	1 9/16	10

Chart continues on page F92

System Overview



Flex Conductor, Two-Hole, Long Barrel with Window Lug (continued)

Terminals

Disconnects

Splices

Ferrules

Part Number	Flex Conductor Size		Code Conductor Size	Stud Hole Size (In.)	Stud Hole Spacing (In.)	Figure Dimensions (In.)				PANDUIT® Color Code	PANDUIT® Die Index No. ‡	Wire Strip Length (In.)	Std. Pkg. Qty.
	Class G, H, I, K, M	Locomotive				W	B	T	L				
LCCX2/0-14A-X	2/0 AWG	2/0 AWG	2/0 AWG	1/4	.63	.96	1.50	.13	3.27	Black	P45	1 9/16	10
LCCX2/0-14B-X				1/4	.75	.96	1.50	.13	3.39	Black	P45	1 9/16	10
LCCX2/0-38D-X				3/8	1.00	.96	1.50	.13	3.70	Black	P45	1 9/16	10
LCCX2/0-12-X	3/0 AWG	3/0 AWG	3/0 AWG	1/2	1.75	.96	1.50	.13	4.87	Black	P45	1 9/16	10
LCCX3/0-14B-X				1/4	.75	1.06	1.56	.14	3.48	Orange	P50	1 5/8	10
LCCX3/0-38D-X				3/8	1.00	1.06	1.56	.14	3.81	Orange	P50	1 5/8	10
LCCX4/0-14B-X	4/0 AWG	4/0 AWG	4/0 AWG	1/4	.75	1.19	2.24	.16	4.07	Purple	P54	2 5/16	10
LCCX4/0-38D-X				3/8	1.00	1.19	2.24	.16	4.55	Purple	P54	2 5/16	10
LCCX4/0-12-X				1/2	1.75	1.19	2.24	.16	5.73	Purple	P54	2 5/16	10
LCCX250-14B-X	250 kcmil	262.6 kcmil	—	1/4	.75	1.28	2.24	.17	4.11	Yellow	P62	2 5/16	10
LCCX250-38D-X				3/8	1.00	1.28	2.24	.17	4.59	Yellow	P62	2 5/16	10
LCCX300-38D-6	300 kcmil	313.1 kcmil	—	3/8	1.00	1.39	2.30	.18	4.67	Red	P71	2 3/8	6
LCCX350-14B-6	350 kcmil	373.7 kcmil	—	1/4	.75	1.54	2.50	.22	4.47	Blue	P76	2 9/16	6
LCCX350-38D-6				3/8	1.00	1.54	2.50	.22	4.95	Blue	P76	2 9/16	6
LCCX350-12-6				1/2	1.75	1.54	2.50	.22	6.13	Blue	P76	2 9/16	6
LCCX500-12-6	500 kcmil	535.3 kcmil	—	1/2	1.75	1.89	2.88	.26	6.66	Pink	P99	2 15/16	6

‡See pages L22, L23 in Technical Info section for tool and die information.

**Consult cable manufacturer for voltage stress relief instructions with applications greater than 2000 volts.

◆NEMA hole sizes and spacing.

Compression Connectors

NEW!



Flex Conductor, Two-Hole, Long Barrel with Window Lug, 45° Angle

For Use with Flexible, Extra-Flexible and Code Stranded Copper Conductors

Crimping Tools

Type LCCX-H

- Can be used with code conductor and flex conductor class: G, H, I, K, M and Locomotive
- Long barrel maximizes number of crimps and provides premium wire pull-out strength and electrical performance
- Generously beveled wire entry prevents bent back strands when inserting conductor into barrel
- Color coded barrels marked with PANDUIT® and specified competitor die index numbers for proper crimp die selection
- Inspection window to visually assure full conductor insertion
- Tin plated to inhibit corrosion
- UL Listed for use up to 35KV**, temperature rated 90°C and CSA Certified to 600V when crimped with PANDUIT® and specified competitor crimping tools and dies
- Meets TIA-607 requirements for network systems grounding applications
- Available with NEMA hole sizes and spacing

Mechanical Connectors

Grounding Connectors

Support Products

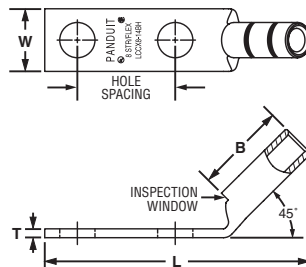

Technical Info

Index

Part Number	Flex Conductor Size		Code Conductor Size	Stud Hole Size (In.)	Stud Hole Spacing (In.)	Figure Dimensions (In.)				PANDUIT® Color Code	PANDUIT® Die Index No. ‡	Wire Strip Length (In.)	Std. Pkg. Qty.
	Class G, H, I, K, M	Locomotive				W	B	T	L				
LCCX8-10AH-L	#8 AWG	#8 AWG	#8 AWG	#10	.63	.41	.70	.08	1.82	Red	P21	3/4	50
LCCX8-10BH-L				#10	.75	.41	.70	.08	1.95	Red	P21	3/4	50
LCCX8-14AH-L				1/4	.63	.48	.70	.07	1.91	Red	P21	3/4	50
LCCX8-14BH-L				1/4	.75	.48	.70	.07	2.03	Red	P21	3/4	50
LCCX8-14DH-L				1/4	1.00	.48	.70	.07	2.28	Red	P21	3/4	50
LCCX8-38DH-L				3/8	1.00	.60	.70	.05	2.49	Red	P21	3/4	50



Flex Conductor, Two-Hole, Long Barrel with Window Lug, 45° Angle (continued)

Part Number	Flex Conductor Size		Code Conductor Size	Stud Hole Size (In.)	Stud Hole Spacing (In.)	Figure Dimensions (In.)				PANDUIT® Color Code	PANDUIT® Die Index No. ‡	Wire Strip Length (In.)	Std. Pkg. Qty.
	Class G, H, I, K, M	Locomotive				W	B	T	L				
LCCX6-10BH-L	#6 AWG	#6 AWG	#6 AWG	#10	.75	.46	1.07	.08	2.22	Blue	P24	1 1/8	50
LCCX6-14AH-L				1/4	.63	.48	1.07	.08	2.18	Blue	P24	1 1/8	50
LCCX6-14BH-L				1/4	.75	.48	1.07	.08	2.31	Blue	P24	1 1/8	50
LCCX6-14DH-L				1/4	1.00	.48	1.07	.08	2.56	Blue	P24	1 1/8	50
LCCX6-38AH-L				3/8	.63	.62	1.07	.06	2.39	Blue	P24	1 1/8	50
LCCX6-38CH-L				3/8	.88	.62	1.07	.06	2.64	Blue	P24	1 1/8	50
LCCX6-38DH-L				3/8	1.00	.62	1.07	.06	2.77	Blue	P24	1 1/8	50
LCCX4-14AH-L				#4 AWG	#5, #4, #3 AWG	#4 - #3 AWG STR, #2 AWG SOL	1/4	.63	.55	1.05	.09	2.20	Gray
LCCX4-14BH-L	1/4	.75	.55				1.05	.09	2.32	Gray	P29	1 1/8	50
LCCX4-38BH-L	3/8	.75	.62				1.05	.08	2.54	Gray	P29	1 1/8	50
LCCX4-38DH-L	3/8	1.00	.62				1.05	.08	2.79	Gray	P29	1 1/8	20
LCCX2-14AH-E	#2 AWG	#2 AWG	#2 AWG	1/4	.63	.70	1.36	.11	2.46	Brown	P33	1 7/16	20
LCCX2-14BH-E				1/4	.75	.70	1.36	.11	2.58	Brown	P33	1 7/16	20
LCCX2-38DH-E				3/8	1.00	.70	1.36	.11	3.04	Brown	P33	1 7/16	20
LCCX2-12H-E				1/2	1.75	.75	1.36	.09	4.20	Brown	P33	1 7/16	10
LCCX1-14AH-X	#1 AWG	#1 AWG	#1 AWG	1/4	.63	.76	1.44	.12	2.61	Green	P37	1 1/2	10
LCCX1-14BH-X				1/4	.75	.76	1.44	.12	2.73	Green	P37	1 1/2	10
LCCX1-14DH-X				1/4	1.00	.76	1.44	.12	2.98	Green	P37	1 1/2	10
LCCX1-56CH-X				5/16	.88	.76	1.44	.12	2.91	Green	P37	1 1/2	10
LCCX1-56DH-X				5/16	1.00	.76	1.44	.12	3.04	Green	P37	1 1/2	10
LCCX1-38DH-X				3/8	1.00	.76	1.44	.12	3.11	Green	P37	1 1/2	10
LCCX1/0-14AH-X	1/0 AWG	1/0 AWG	1/0 AWG	1/4	.63	.85	1.50	.13	2.76	Pink	P42	1 9/16	10
LCCX1/0-14BH-X				1/4	.75	.85	1.50	.13	2.88	Pink	P42	1 9/16	10
LCCX1/0-38DH-X				3/8	1.00	.85	1.50	.13	3.20	Pink	P42	1 9/16	10
LCCX1/0-12H-X				1/2	1.75	.85	1.50	.13	4.36	Pink	P42	1 9/16	10
LCCX2/0-14AH-X	2/0 AWG	2/0 AWG	2/0 AWG	1/4	.63	.96	1.50	.13	2.78	Black	P45	1 9/16	10
LCCX2/0-14BH-X				1/4	.75	.96	1.50	.13	2.91	Black	P45	1 9/16	10
LCCX2/0-38DH-X				3/8	1.00	.96	1.50	.13	3.22	Black	P45	1 9/16	10
LCCX2/0-12H-X				1/2	1.75	.96	1.50	.13	4.38	Black	P45	1 9/16	10
LCCX3/0-14BH-X	3/0 AWG	3/0 AWG	3/0 AWG	1/4	.75	1.06	1.56	.14	2.98	Orange	P50	1 5/8	10
LCCX3/0-38DH-X				3/8	1.00	1.06	1.56	.14	3.31	Orange	P50	1 5/8	10
LCCX4/0-14BH-X	4/0 AWG	4/0 AWG	4/0 AWG	1/4	.75	1.19	2.24	.16	3.45	Purple	P54	2 5/16	10
LCCX4/0-38DH-X				3/8	1.00	1.19	2.24	.16	3.93	Purple	P54	2 5/16	10
LCCX4/0-12H-X	1/2	1.75	1.19	2.24	.16	5.11	Purple	P54	2 5/16	10			
LCCX250-14BH-X	250 kcmil	262.6 kcmil	—	1/4	.75	1.28	2.24	.17	3.48	Yellow	P62	2 5/16	10
LCCX250-38DH-X				3/8	1.00	1.28	2.24	.17	3.96	Yellow	P62	2 5/16	6
LCCX300-38DH-6	300 kcmil	313.1 kcmil	—	3/8	1.00	1.39	2.30	.18	4.07	Red	P71	2 3/8	6
LCCX350-14BH-6	350 kcmil	373.7 kcmil	—	1/4	.75	1.54	2.50	.22	3.81	Blue	P76	2 9/16	6
LCCX350-38DH-6				3/8	1.00	1.54	2.50	.22	4.29	Blue	P76	2 9/16	6
LCCX350-12H-6				1/2	1.75	1.54	2.50	.22	5.47	Blue	P76	2 9/16	6

‡See pages L22, L23 in Technical Info section for tool and die information.

**Consult cable manufacturer for voltage stress relief instructions with applications greater than 2000 volts.

◆NEMA hole sizes and spacing

System Overview

Terminals

Disconnects

Splices

Ferrules

Compression Connectors

Crimping Tools

Mechanical Connectors

Grounding Connectors

Support Products

Technical Info

Index

System Overview

NEW!



Flex Conductor, Two-Hole, Long Barrel with Window Lug, 90° Angle

For Use with Flexible, Extra-Flexible and Code Stranded Copper Conductors

Terminals

Type LCCX-F

- Can be used with code conductor and flex conductor class: G, H, I, K, M and Locomotive
- Long barrel maximizes number of crimps and provides premium wire pull-out strength and electrical performance
- Generously beveled wire entry prevents bent back strands when inserting conductor into barrel
- Color coded barrels marked with **PANDUIT®** and specified competitor die index numbers for proper crimp die selection
- Inspection window to visually assure full conductor insertion
- Tin plated to inhibit corrosion
- UL Listed for use up to 35KV**, temperature rated 90°C and CSA Certified to 600V when crimped with **PANDUIT®** and specified competitor crimping tools and dies
- Meets TIA-607 requirements for network systems grounding applications
- Available with NEMA hole sizes and spacing

Disconnects

Splices

Ferrules

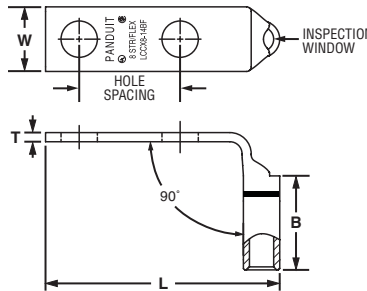

Compression Connectors

Crimping Tools

Mechanical Connectors

Grounding Connectors

Support Products

Technical Info

Index

Part Number	Flex Conductor Size		Code Conductor Size	Stud Hole Size (In.)	Stud Hole Spacing (In.)	Figure Dimensions (In.)				PANDUIT® Color Code	PANDUIT® Die Index No. ‡	Wire Strip Length (In.)	Std. Pkg. Qty.
	Class G, H, I, K, M	Locomotive				W	B	T	L				
LCCX8-10AF-L	#8 AWG	#8 AWG	#8 AWG	#10	.63	.41	.70	.08	1.53	Red	P21	3/4	50
LCCX8-10BF-L				#10	.75	.41	.70	.08	1.65	Red	P21	3/4	50
LCCX8-14AF-L				1/4	.63	.48	.70	.07	1.62	Red	P21	3/4	50
LCCX8-14BF-L				1/4	.75	.48	.70	.07	1.74	Red	P21	3/4	50
LCCX8-14DF-L				1/4	1.00	.48	.70	.07	1.99	Red	P21	3/4	50
LCCX8-38DF-L				3/8	1.00	.60	.70	.05	2.21	Red	P21	3/4	50
LCCX6-10BF-L	#6 AWG	#6 AWG	#6 AWG	#10	.75	.46	1.07	.08	1.69	Blue	P24	1 1/8	50
LCCX6-14AF-L				1/4	.63	.48	1.07	.08	1.66	Blue	P24	1 1/8	50
LCCX6-14BF-L				1/4	.75	.48	1.07	.08	1.78	Blue	P24	1 1/8	50
LCCX6-14DF-L				1/4	1.00	.48	1.07	.08	2.03	Blue	P24	1 1/8	50
LCCX6-38AF-L				3/8	.63	.62	1.07	.06	1.88	Blue	P24	1 1/8	50
LCCX6-38CF-L				3/8	.88	.62	1.07	.06	2.13	Blue	P24	1 1/8	50
LCCX6-38DF-L	3/8	1.00	.62	1.07	.06	2.25	Blue	P24	1 1/8	50			
LCCX4-14AF-L	#4 AWG	#5, #4, #3 AWG	#4 - #3 AWG STR, #2 AWG SOL	1/4	.63	.55	1.05	.09	1.74	Gray	P29	1 1/8	50
LCCX4-14BF-L				1/4	.75	.55	1.05	.09	1.87	Gray	P29	1 1/8	50
LCCX4-38BF-L				3/8	.75	.62	1.05	.08	2.09	Gray	P29	1 1/8	50
LCCX4-38DF-L				3/8	1.00	.62	1.05	.08	2.34	Gray	P29	1 1/8	50
LCCX2-14AF-E	#2 AWG	#2 AWG	#2 AWG	1/4	.63	.70	1.36	.11	1.94	Brown	P33	1 7/16	20
LCCX2-14BF-E				1/4	.75	.70	1.36	.11	2.06	Brown	P33	1 7/16	20
LCCX2-38DF-E				3/8	1.00	.70	1.36	.11	2.51	Brown	P33	1 7/16	20
LCCX2-12F-E				1/2	1.75	.75	1.36	.09	3.68	Brown	P33	1 7/16	20
LCCX1-14AF-X	#1 AWG	#1 AWG	#1 AWG	1/4	.63	.76	1.44	.12	2.08	Green	P37	1 1/2	10
LCCX1-14BF-X				1/4	.75	.76	1.44	.12	2.20	Green	P37	1 1/2	10
LCCX1-14DF-X				1/4	1.00	.76	1.44	.12	2.45	Green	P37	1 1/2	10
LCCX1-56CF-X				5/16	.88	.76	1.44	.12	2.38	Green	P37	1 1/2	10
LCCX1-56DF-X				5/16	1.00	.76	1.44	.12	2.51	Green	P37	1 1/2	10
LCCX1-38DF-X				3/8	1.00	.76	1.44	.12	2.58	Green	P37	1 1/2	10
LCCX1/0-14AF-X	1/0 AWG	1/0 AWG	1/0 AWG	1/4	.63	.85	1.50	.13	2.22	Pink	P42	1 9/16	10
LCCX1/0-14BF-X				1/4	.75	.85	1.50	.13	2.34	Pink	P42	1 9/16	10
LCCX1/0-38DF-X				3/8	1.00	.85	1.50	.13	2.66	Pink	P42	1 9/16	10
LCCX1/0-12F-X				1/2	1.75	.85	1.50	.13	3.82	Pink	P42	1 9/16	10



Flex Conductor, Two-Hole, Long Barrel with Window Lug, 90° Angle (continued)

Part Number	Flex Conductor Size		Code Conductor Size	Stud Hole Size (In.)	Stud Hole Spacing (In.)	Figure Dimensions (In.)				PANDUIT® Color Code	PANDUIT® Die Index No. ‡	Wire Strip Length (In.)	Std. Pkg. Qty.
	Class G, H, I, K, M	Locomotive				W	B	T	L				
LCCX2/0-14AF-X	2/0 AWG	2/0 AWG	2/0 AWG	1/4	.63	.96	1.50	.13	2.29	Black	P45	1 9/16	10
LCCX2/0-14BF-X				1/4	.75	.96	1.50	.13	2.42	Black	P45	1 9/16	10
LCCX2/0-38DF-X				3/8	1.00	.96	1.50	.13	2.73	Black	P45	1 9/16	10
LCCX2/0-12F-X				1/2	1.75	.96	1.50	.13	3.89	Black	P45	1 9/16	10
LCCX3/0-14BF-X	3/0 AWG	3/0 AWG	3/0 AWG	1/4	.75	1.06	1.56	.14	2.50	Orange	P50	1 5/8	10
LCCX3/0-38DF-X				3/8	1.00	1.06	1.56	.14	2.84	Orange	P50	1 5/8	10
LCCX4/0-14BF-X	4/0 AWG	4/0 AWG	4/0 AWG	1/4	.75	1.19	2.24	.16	2.69	Purple	P54	2 5/16	10
LCCX4/0-38DF-X				3/8	1.00	1.19	2.24	.16	2.88	Purple	P54	2 5/16	10
LCCX4/0-12F-X				1/2	1.75	1.19	2.24	.16	4.06	Purple	P54	2 5/16	10
LCCX250-14BF-X	250 kcmil	262.6 kcmil	—	1/4	.75	1.28	2.24	.17	2.46	Yellow	P62	2 5/16	10
LCCX250-38DF-X				3/8	1.00	1.28	2.24	.17	2.94	Yellow	P62	2 5/16	10
LCCX300-38DF-6	300 kcmil	313.1 kcmil	—	3/8	1.00	1.39	2.30	.18	3.02	Red	P71	2 3/8	6
LCCX350-14BF-6	350 kcmil	373.7 kcmil	—	1/4	.75	1.54	2.50	.22	2.65	Blue	P76	2 9/16	6
LCCX350-38DF-6				3/8	1.00	1.54	2.50	.22	3.13	Blue	P76	2 9/16	6
LCCX350-12F-6				1/2	1.75	1.54	2.50	.22	4.31	Blue	P76	2 9/16	6

‡See pages L22, L23 in Technical Info section for tool and die information.

**Consult cable manufacturer for voltage stress relief instructions with applications greater than 2000 volts.

◆NEMA hole sizes and spacing.



Flex Conductor, Two-Hole, Long Barrel, Flared Lug

For Use with Flexible and Extra-Flexible Copper Conductors

Type LCCF

- Can be used with flex conductor class: K, M and Locomotive
- Long barrel maximizes the number of crimps and provides premium wire pull-out strength and electrical performance
- Flared entry prevents bent back strands when inserting fine strand conductor into barrel
- Color coded barrels marked with PANDUIT® die index numbers for proper crimp die selection
- Enclosed barrel prevents corrosive material from entering barrel when used in harsh environments
- Tin plated to inhibit corrosion
- UL Listed for use up to 35KV** and temperature rated 90°C and CSA Certified to 600V when crimped with PANDUIT® crimping tools and dies
- Tested by Telcordia — meets NEBS Level 3
- Available with NEMA hole sizes and spacing

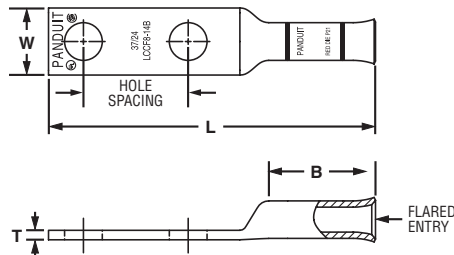

Part Number	Flex Conductor Size		Stud Hole Size (In.)	Stud Hole Spacing (In.)	Figure Dimensions (In.)				PANDUIT® Color Code	PANDUIT® Die Index No. ‡	Wire Strip Length (In.)	Std. Pkg. Qty.
	Class K & M	Locomotive			W	B	T	L				
LCCF8-14A-L	—	#8 AWG	1/4	.63	.48	.76	.07	2.22	Red	P21	13/16	50
LCCF8-14B-L			1/4	.75	.48	.76	.07	2.34	Red	P21	13/16	50
LCCF8-38D-L			3/8	1.00	.60	.76	.05	2.81	Red	P21	13/16	50
LCCF6-14A-L	#6 AWG	#6 AWG	1/4	.63	.48	1.22	.08	2.71	Blue	P24	1 5/16	50
LCCF6-14B-L			1/4	.75	.48	1.22	.08	2.83	Blue	P24	1 5/16	50
LCCF6-38D-L			3/8	1.00	.62	1.22	.06	3.30	Blue	P24	1 5/16	50
LCCF4-14A-L	#4 AWG	#4 AWG	1/4	.63	.55	1.23	.09	2.75	Gray	P29	1 5/16	50
LCCF4-14B-L			1/4	.75	.55	1.23	.09	2.88	Gray	P29	1 5/16	50
LCCF4-38D-L			3/8	1.00	.62	1.23	.08	3.35	Gray	P29	1 5/16	50

Chart continues on page F96

PANDUIT® TERMINATION SOLUTIONS

System Overview



Flex Conductor, Two-Hole, Long Barrel, Flared Lug (continued)

Terminals	Part Number	Flex Conductor Size		Stud Hole Size (In.)	Stud Hole Spacing (In.)	Figure Dimensions (In.)				PANDUIT® Color Code	PANDUIT® Die Index No. ‡	Wire Strip Length (In.)	Std. Pkg. Qty.
		Class K & M	Locomotive			W	B	T	L				
Disconnects	LCCF2-14A-E	#2 AWG	#2 AWG	1/4	.63	.70	1.36	.11	3.00	Brown	P33	1 7/16	20
	LCCF2-14B-E			1/4	.75	.70	1.36	.11	3.12	Brown	P33	1 7/16	20
	LCCF2-56B-E			5/16	.75	.70	1.36	.11	3.25	Brown	P33	1 7/16	20
	LCCF2-38D-E			3/8	1.00	.70	1.36	.11	3.57	Brown	P33	1 7/16	20
	LCCF2-12-E			1/2	1.75	.75	1.36	.09	4.74	Brown	P33	1 7/16	20
Splices	LCCF1-14A-X	#1 AWG	#1 AWG	1/4	.63	.76	1.44	.12	3.18	Pink	P42	1 1/12	10
	LCCF1-14B-X			1/4	.75	.76	1.44	.12	3.31	Pink	P42	1 1/2	10
	LCCF1-56C-X			5/16	.88	.76	1.44	.12	3.49	Pink	P42	1 1/2	10
	LCCF1-38D-X			3/8	1.00	.76	1.44	.12	3.69	Pink	P42	1 1/2	10
Ferrules	LCCF1-12-X	1/0 AWG	1/0 AWG	1/2	1.75	.80	1.44	.12	4.86	Pink	P42	1 1/2	10
	LCCF1/0-14A-X			1/4	.63	.85	1.50	.13	3.38	Black	P45	1 9/16	10
	LCCF1/0-14B-X			1/4	.75	.85	1.50	.13	3.51	Black	P45	1 9/16	10
	LCCF1/0-56C-X			5/16	.88	.85	1.50	.13	3.63	Black	P45	1 9/16	10
Compression Connectors	LCCF1/0-38D-X	2/0 AWG	2/0 AWG	3/8	1.00	.85	1.50	.13	3.82	Black	P45	1 9/16	10
	LCCF1/0-12-X			1/2	1.75	.85	1.50	.13	4.98	Black	P45	1 9/16	10
	LCCF2/0-14A-X			1/4	.63	.96	1.50	.13	3.43	Orange	P50	1 9/16	10
	LCCF2/0-14B-X			1/4	.75	.96	1.50	.13	3.56	Orange	P50	1 9/16	10
Crimping Tools	LCCF2/0-38D-X	3/0 AWG	3/0 AWG	3/8	1.00	.96	1.50	.13	3.87	Orange	P50	1 9/16	10
	LCCF2/0-12-X			1/2	1.75	.96	1.50	.13	5.03	Orange	P50	1 9/16	10
	LCCF3/0-14B-X			1/4	.75	1.06	1.56	.14	3.66	Purple	P54	1 5/8	10
	LCCF3/0-38D-X			3/8	1.00	1.06	1.56	.14	3.99	Purple	P54	1 5/8	10
Mechanical Connectors	LCCF3/0-12-X	4/0 AWG	4/0 AWG	1/2	1.75	1.06	1.56	.14	5.13	Purple	P54	1 5/8	10
	LCCF4/0-14B-X			1/4	.75	1.17	1.61	.14	3.60	Yellow	P62	1 11/16	10
	LCCF4/0-38D-X			3/8	1.00	1.17	1.61	.14	4.09	Yellow	P62	1 11/16	10
	LCCF4/0-38-X			3/8	1.75	1.17	1.61	.14	4.84	Yellow	P62	1 11/16	10
Grounding Connectors	LCCF4/0-12-X	250 kcmil	262.6 kcmil	1/2	1.75	1.17	1.61	.14	5.23	Yellow	P62	1 11/16	10
	LCCF250-14B-X			1/4	.75	1.28	2.24	.17	4.33	White	P66	2 5/16	10
	LCCF250-38D-X			3/8	1.00	1.28	2.24	.17	4.81	White	P66	2 5/16	10
	LCCF250-12E-X			1/2	1.25	1.28	2.24	.17	5.49	White	P66	2 5/16	10
Support Products	LCCF250-12-X	300 kcmil	313.1 kcmil	1/2	1.75	1.28	2.24	.17	5.99	White	P66	2 5/16	10
	LCCF300-14B-6			1/4	.75	1.38	2.30	.18	4.44	Red	P71	2 3/8	6
	LCCF300-38D-6			3/8	1.00	1.38	2.30	.18	4.92	Red	P71	2 3/8	6
	LCCF300-12-6			1/2	1.75	1.38	2.30	.18	6.10	Red	P71	2 3/8	6
Technical Info	LCCF350-14B-6	350 kcmil	373.7 kcmil	1/4	.75	1.53	2.50	.22	4.70	Blue	P76	2 9/16	6
	LCCF350-38D-6			3/8	1.00	1.53	2.50	.22	5.18	Blue	P76	2 9/16	6
	LCCF350-12E-6			1/2	1.25	1.53	2.50	.22	5.86	Blue	P76	2 9/16	6
	LCCF350-12-6			1/2	1.75	1.53	2.50	.22	6.36	Blue	P76	2 9/16	6
Index	LCCF400-38D-6	400 kcmil	444.4 kcmil	3/8	1.00	1.70	2.69	.26	5.45	Brown	P87	2 3/4	6
	LCCF400-12-6			1/2	1.75	1.70	2.69	.26	6.63	Brown	P87	2 3/4	6
	LCCF500-12-6			1/2	1.75	1.89	2.88	.26	7.04	Pink	P99	2 15/16	6
	LCCF600-12-6			—	646.4 kcmil	1/2	1.75	1.95	2.94	.29	7.13	Black	P106
Index	LCCF750-38D-3	—	777.7 kcmil	3/8	1.00	2.17	3.00	.32	6.35	Orange	P107	3 1/16	3
	LCCF750-12-3			1/2	1.75	2.17	3.00	.32	7.29	Orange	P107	3 1/16	3

‡See pages L24, L25 in Technical Info section for tool and die information.

**Consult cable manufacturer for voltage stress relief instructions with applications greater than 2000 volts.

◆NEMA hole sizes and spacing.

NEW!



Flex Conductor, Two-Hole, Long Barrel, Flared Lug, 45° Angle

For Use with Flexible and Extra-Flexible Copper Conductors

Type LCCF-H

- Can be used with flex conductor class: K, M and Locomotive
- Long barrel maximizes the number of crimps and provides premium wire pull-out strength and electrical performance
- Flared entry prevents bent back strands when inserting fine strand conductor into barrel
- Color coded barrels marked with PANDUIT® die index numbers for proper crimp die selection
- Enclosed barrel prevents corrosive material from entering barrel when used in harsh environments
- Tin plated to inhibit corrosion
- UL Listed for use up to 35KV** and temperature rated 90°C and CSA Certified to 600V when crimped with PANDUIT® crimping tools and dies
- Tested by Telcordia — meets NEBS Level 3
- Available with NEMA hole sizes and spacing

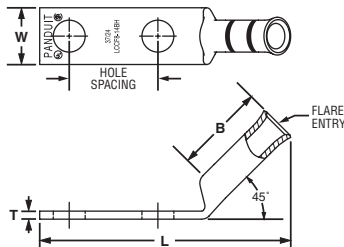

Part Number	Flex Conductor Size		Stud Hole Size (In.)	Stud Hole Spacing (In.)	Figure Dimensions (In.)				PANDUIT® Color Code	PANDUIT® Die Index No. ‡	Wire Strip Length (In.)	Std. Pkg. Qty.
	Class K & M	Locomotive			W	B	T	L				
LCCF8-14AH-L	—	#8 AWG	1/4	.63	.48	.76	.07	2.00	Red	P21	13/16	50
LCCF8-14BH-L			1/4	.75	.48	.76	.07	2.12	Red	P21	13/16	50
LCCF8-38DH-L			3/8	1.00	.60	.76	.05	2.58	Red	P21	13/16	50
LCCF6-14AH-L	#6 AWG	#6 AWG	1/4	.63	.48	1.22	.08	2.36	Blue	P24	1 5/16	50
LCCF6-14BH-L			1/4	.75	.48	1.22	.08	2.48	Blue	P24	1 5/16	50
LCCF6-38DH-L			3/8	1.00	.62	1.22	.06	2.94	Blue	P24	1 5/16	50
LCCF4-14AH-L	#4 AWG	#4 AWG	1/4	.63	.55	1.23	.09	2.41	Gray	P29	1 5/16	50
LCCF4-14BH-L			1/4	.75	.55	1.23	.09	2.54	Gray	P29	1 5/16	50
LCCF4-38DH-L			3/8	1.00	.62	1.23	.08	3.00	Gray	P29	1 5/16	50
LCCF2-14AH-E	#2 AWG	#2 AWG	1/4	.63	.70	1.36	.11	2.56	Brown	P33	1 7/16	20
LCCF2-14BH-E			1/4	.75	.70	1.36	.11	2.68	Brown	P33	1 7/16	20
LCCF2-56BH-E			5/16	.75	.70	1.36	.11	2.81	Brown	P33	1 7/16	20
LCCF2-38DH-E			3/8	1.00	.70	1.36	.11	3.13	Brown	P33	1 7/16	20
LCCF2-12H-E			1/2	1.75	.75	1.36	.09	4.30	Brown	P33	1 7/16	20
LCCF1-14AH-X	#1 AWG	#1 AWG	1/4	.63	.76	1.44	.12	2.71	Pink	P42	1 1/2	10
LCCF1-14BH-X			1/4	.75	.76	1.44	.12	2.84	Pink	P42	1 1/2	10
LCCF1-56CH-X			5/16	.88	.76	1.44	.12	3.02	Pink	P42	1 1/2	10
LCCF1-38DH-X			3/8	1.00	.76	1.44	.12	3.22	Pink	P42	1 1/2	10
LCCF1-12H-X			1/2	1.75	.80	1.44	.12	4.38	Pink	P42	1 1/2	10
LCCF1/0-14AH-X	1/0 AWG	1/0 AWG	1/4	.63	.85	1.50	.13	2.90	Black	P45	1 9/16	10
LCCF1/0-14BH-X			1/4	.75	.85	1.50	.13	3.02	Black	P45	1 9/16	10
LCCF1/0-56CH-X			5/16	.88	.85	1.50	.13	3.15	Black	P45	1 9/16	10
LCCF1/0-38DH-X			3/8	1.00	.85	1.50	.13	3.34	Black	P45	1 9/16	10
LCCF1/0-12H-X			1/2	1.75	.85	1.50	.13	4.50	Black	P45	1 9/16	10
LCCF2/0-14AH-X	2/0 AWG	2/0 AWG	1/4	.63	.96	1.50	.13	2.92	Orange	P50	1 9/16	10
LCCF2/0-14BH-X			1/4	.75	.96	1.50	.13	3.05	Orange	P50	1 9/16	10
LCCF2/0-38DH-X			3/8	1.00	.96	1.50	.13	3.36	Orange	P50	1 9/16	10
LCCF2/0-12H-X			1/2	1.75	.96	1.50	.13	4.52	Orange	P50	1 9/16	10
LCCF3/0-14BH-X	3/0 AWG	3/0 AWG	1/4	.75	1.06	1.56	.14	3.14	Purple	P54	1 5/8	10
LCCF3/0-38DH-X			3/8	1.00	1.06	1.56	.14	3.47	Purple	P54	1 5/8	10
LCCF3/0-12H-X			1/2	1.75	1.06	1.56	.14	4.61	Purple	P54	1 5/8	10

Chart continues on page F98

System Overview



Flex Conductor, Two-Hole, Long Barrel, Flared Lug, 45° Angle (continued)

Terminals

Disconnects

Splices

Ferrules

Compression Connectors

Crimping Tools

Mechanical Connectors

Grounding Connectors

Support Products

Technical Info

Index

Part Number	Flex Conductor Size		Stud Hole Size (In.)	Stud Hole Spacing (In.)	Figure Dimensions (In.)				PANDUIT® Color Code	PANDUIT® Die Index No. ‡	Wire Strip Length (In.)	Std. Pkg. Qty.
	Class K & M	Locomotive			W	B	T	L				
LCCF4/0-14BH-X	4/0 AWG	4/0 AWG	1/4	.75	1.17	1.61	.14	3.06	Yellow	P62	1 11/16	10
LCCF4/0-38DH-X			3/8	1.00	1.17	1.61	.14	3.55	Yellow	P62	1 11/16	10
LCCF4/0-38H-X			3/8	1.75	1.17	1.61	.14	4.30	Yellow	P62	1 11/16	10
◆ LCCF4/0-12H-X			1/2	1.75	1.17	1.61	.14	4.69	Yellow	P62	1 11/16	10
LCCF250-14BH-X	250 kcmil	262.6 kcmil	1/4	.75	1.28	2.24	.17	3.66	White	P66	2 5/16	10
LCCF250-38DH-X			3/8	1.00	1.28	2.24	.17	4.14	White	P66	2 5/16	10
LCCF250-12EH-X			1/2	1.25	1.28	2.24	.17	4.82	White	P66	2 5/16	10
◆ LCCF250-12H-X			1/2	1.75	1.28	2.24	.17	5.32	White	P66	2 5/16	10
LCCF300-14BH-6	300 kcmil	313.1 kcmil	1/4	.75	1.38	2.30	.18	3.77	Red	P71	2 3/8	6
LCCF300-38DH-6			3/8	1.00	1.38	2.30	.18	4.25	Red	P71	2 3/8	6
◆ LCCF300-12H-6			1/2	1.75	1.38	2.30	.18	5.43	Red	P71	2 3/8	6
LCCF350-14BH-6			350 kcmil	373.7 kcmil	1/4	.75	1.53	2.50	.22	3.98	Blue	P76
LCCF350-38DH-6	3/8	1.00			1.53	2.50	.22	4.46	Blue	P76	2 9/16	6
LCCF350-12EH-6	1/2	1.25			1.53	2.50	.22	5.14	Blue	P76	2 9/16	6
◆ LCCF350-12H-6	1/2	1.75			1.53	2.50	.22	5.64	Blue	P76	2 9/16	6
LCCF400-38DH-6	400 kcmil	444.4 kcmil	3/8	1.00	1.70	2.69	.26	4.66	Brown	P87	2 3/4	6
◆ LCCF400-12H-6			1/2	1.75	1.70	2.69	.26	5.84	Brown	P87	2 3/4	6
◆ LCCF500-12H-6	500 kcmil	535.3 kcmil	1/2	1.75	1.89	2.88	.26	6.18	Pink	P99	2 15/16	6
◆ LCCF600-12H-6	—	646.4 kcmil	1/2	1.75	1.95	2.94	.29	6.25	Black	P106	3	6
LCCF750-38DH-3	—	777.7 kcmil	3/8	1.00	2.17	3.00	.32	5.45	Orange	P107	3 1/16	3
◆ LCCF750-12H-3			1/2	1.75	2.17	3.00	.32	6.39	Orange	P107	3 1/16	3

‡See [pages L24, L25](#) in Technical Info section for tool and die information.
 **Consult cable manufacturer for voltage stress relief instructions with applications greater than 2000 volts.
 ◆NEMA hole sizes and spacing.

NEW!



Flex Conductor, Two-Hole, Long Barrel, Flared Lug, 90° Angle

For Use with Flexible and Extra-Flexible Copper Conductors

Type LCCF-F

- Can be used with flex conductor class: K, M and Locomotive
- Long barrel maximizes the number of crimps and provides premium wire pull-out strength and electrical performance
- Flared entry prevents bent back strands when inserting fine strand conductor into barrel
- Color coded barrels marked with PANDUIT® die index numbers for proper crimp die selection
- Enclosed barrel prevents corrosive material from entering barrel when used in harsh environments
- Tin plated to inhibit corrosion
- UL Listed for use up to 35KV** and temperature rated 90°C and CSA Certified to 600V when crimped with PANDUIT® crimping tools and dies
- Tested by Telcordia — meets NEBS Level 3
- Available with NEMA hole sizes and spacing

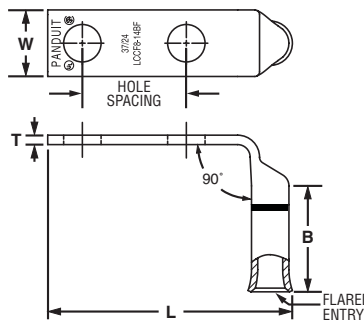

Part Number	Flex Conductor Size		Stud Hole Size (In.)	Stud Hole Spacing (In.)	Figure Dimensions (In.)				PANDUIT® Color Code	PANDUIT® Die Index No. ‡	Wire Strip Length (In.)	Std. Pkg. Qty.
	Class K & M	Locomotive			W	B	T	L				
LCCF8-14AF-L	—	#8 AWG	1/4	.63	.48	.76	.07	1.64	Red	P21	13/16	50
LCCF8-14BF-L			1/4	.75	.48	.76	.07	1.77	Red	P21	13/16	50
LCCF8-38DF-L			3/8	1.00	.60	.76	.05	2.24	Red	P21	13/16	50
LCCF6-14AF-L	#6 AWG	#6 AWG	1/4	.63	.48	1.22	.08	1.69	Blue	P24	1 5/16	50
LCCF6-14BF-L			1/4	.75	.48	1.22	.08	1.81	Blue	P24	1 5/16	50
LCCF6-38DF-L			3/8	1.00	.62	1.22	.06	2.28	Blue	P24	1 5/16	50
LCCF4-14AF-L	#4 AWG	#4 AWG	1/4	.63	.55	1.23	.09	1.78	Gray	P29	1 5/16	50
LCCF4-14BF-L			1/4	.75	.55	1.23	.09	1.91	Gray	P29	1 5/16	50
LCCF2-14BF-E	#2 AWG	#2 AWG	1/4	.75	.70	1.36	.11	2.10	Brown	P33	1 7/16	20
LCCF2-56BF-E			5/16	.75	.70	1.36	.11	2.23	Brown	P33	1 7/16	20
LCCF2-38DF-E			3/8	1.00	.70	1.36	.11	2.55	Brown	P33	1 7/16	20
LCCF2-12F-E			1/2	1.75	.79	1.36	.09	3.72	Brown	P33	1 7/16	20
LCCF1-14AF-X	#1 AWG	#1 AWG	1/4	.63	.76	1.44	.12	2.11	Pink	P42	1 1/2	10
LCCF1-14BF-X			1/4	.75	.76	1.44	.12	2.24	Pink	P42	1 1/2	10
LCCF1-56CF-X			5/16	.88	.76	1.44	.12	2.42	Pink	P42	1 1/2	10
LCCF1-38DF-X			3/8	1.00	.76	1.44	.12	2.62	Pink	P42	1 1/2	10
LCCF1-12F-X			1/2	1.75	.80	1.44	.11	3.79	Pink	P42	1 1/2	10
LCCF1/0-14AF-X	1/0 AWG	1/0 AWG	1/4	.63	.85	1.50	.13	2.27	Black	P45	1 9/16	10
LCCF1/0-14BF-X			1/4	.75	.85	1.50	.13	2.39	Black	P45	1 9/16	10
LCCF1/0-56CF-X			5/16	.88	.85	1.50	.13	2.52	Black	P45	1 9/16	10
LCCF1/0-38DF-X			3/8	1.00	.85	1.50	.13	2.70	Black	P45	1 9/16	10
LCCF1/0-12F-X			1/2	1.75	.85	1.50	.13	3.87	Black	P45	1 9/16	10
LCCF2/0-14AF-X	2/0 AWG	2/0 AWG	1/4	.63	.96	1.50	.13	2.33	Orange	P50	1 9/16	10
LCCF2/0-14BF-X			1/4	.75	.96	1.50	.13	2.46	Orange	P50	1 9/16	10
LCCF2/0-38DF-X			3/8	1.00	.96	1.50	.13	2.77	Orange	P50	1 9/16	10
LCCF2/0-12F-X			1/2	1.75	.96	1.50	.13	3.93	Orange	P50	1 9/16	10
LCCF3/0-14BF-X	3/0 AWG	3/0 AWG	1/4	.75	1.06	1.56	.14	2.56	Purple	P54	1 5/8	10
LCCF3/0-38DF-X			3/8	1.00	1.06	1.56	.14	2.89	Purple	P54	1 5/8	10
LCCF3/0-12F-X			1/2	1.75	1.06	1.56	.14	4.03	Purple	P54	1 5/8	10

Chart continues on page F100

System Overview



Flex Conductor, Two-Hole, Long Barrel, Flared Lug, 90° Angle (continued)

Terminals

Disconnects

Splices

Ferrules

Compression Connectors

Crimping Tools

Mechanical Connectors

Grounding Connectors

Support Products

Technical Info

Index

Part Number	Flex Conductor Size		Stud Hole Size (In.)	Stud Hole Spacing (In.)	Figure Dimensions (In.)				PANDUIT® Color Code	PANDUIT® Die Index No. ‡	Wire Strip Length (In.)	Std. Pkg. Qty.
	Class K & M	Locomotive			W	B	T	L				
LCCF4/0-14BF-X	4/0 AWG	4/0 AWG	1/4	.75	1.17	1.61	.14	2.48	Yellow	P62	1 11/16	10
LCCF4/0-38DF-X			3/8	1.00	1.17	1.61	.14	2.97	Yellow	P62	1 11/16	10
LCCF4/0-38F-X			3/8	1.75	1.17	1.61	.14	3.72	Yellow	P62	1 11/16	10
LCCF4/0-12F-X			1/2	1.75	1.17	1.61	.14	4.11	Yellow	P62	1 11/16	10
LCCF250-14BF-X	250 kcmil	262.6 kcmil	1/4	.75	1.28	2.24	.17	2.54	White	P66	2 5/16	10
LCCF250-38DF-X			3/8	1.00	1.28	2.24	.17	3.02	White	P66	2 5/16	10
LCCF250-12EF-X			1/2	1.25	1.28	2.24	.17	3.70	White	P66	2 5/16	10
LCCF250-12F-X	300 kcmil	313.1 kcmil	1/2	1.75	1.28	2.24	.17	4.20	White	P66	2 5/16	10
LCCF300-14BF-6			1/4	.75	1.38	2.30	.18	2.61	Red	P71	2 3/8	6
LCCF300-38DF-6			3/8	1.00	1.38	2.30	.18	3.09	Red	P71	2 3/8	6
LCCF300-12F-6			1/2	1.75	1.38	2.30	.18	4.27	Red	P71	2 3/8	6
LCCF350-14BF-6	350 kcmil	373.7 kcmil	1/4	.75	1.53	2.50	.22	2.73	Blue	P76	2 9/16	6
LCCF350-38DF-6			3/8	1.00	1.53	2.50	.22	3.21	Blue	P76	2 9/16	6
LCCF350-12EF-6			1/2	1.25	1.53	2.50	.22	3.89	Blue	P76	2 9/16	6
LCCF350-12F-6			1/2	1.75	1.53	2.50	.22	4.39	Blue	P76	2 9/16	6
LCCF400-38DF-6	400 kcmil	444.4 kcmil	3/8	1.00	1.70	2.69	.26	3.33	Brown	P87	2 3/4	6
LCCF400-12F-6			1/2	1.75	1.70	2.69	.26	4.51	Brown	P87	2 3/4	6
LCCF500-12F-6	500 kcmil	535.3 kcmil	1/2	1.75	1.89	2.88	.26	4.67	Pink	P99	2 15/16	6
LCCF600-12F-6	—	646.4 kcmil	1/2	1.75	1.95	2.88	.29	4.73	Black	P106	3	6
LCCF750-38DF-3	—	777.7 kcmil	3/8	1.00	2.17	3.00	.32	3.96	Orange	P107	3 1/16	3
LCCF750-12F-3			1/2	1.75	2.17	3.00	.32	4.90	Orange	P107	3 1/16	3

‡See [pages L24, L25](#) in Technical Info section for tool and die information.

**Consult cable manufacturer for voltage stress relief instructions with applications greater than 2000 volts.

◆NEMA hole sizes and spacing.



Flex Conductor, Standard Barrel, Flared, Butt Splice

For Use with Flexible and Extra-Flexible Copper Conductors

Type SCSF

- Can be used with flex conductor class: K, M and Locomotive
- Flared entry prevents bent back strands when inserting fine strand conductor into barrel
- Color coded barrels marked with PANDUIT® die index numbers for proper crimp die selection
- Internal wire stops to prevent over-insertion of conductor
- Tin plated to inhibit corrosion
- UL Listed for use up to 35KV** and temperature rated 90°C and CSA Certified to 600V when crimped with PANDUIT® crimping tools and dies
- Tested by Telcordia — meets NEBS Level 3

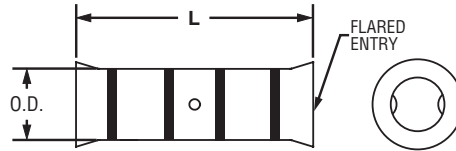

Part Number	Flex Conductor Size		Figure Dimensions (In.)		PANDUIT® Color Code	PANDUIT® Die Index No.‡	Wire Strip Length (In.)	Std. Pkg. Qty.
	Class K & M	Locomotive	Barrel O.D.	L				
SCSF8-L	—	#8 AWG	.27	1.50	Red	P21	11/16	50
SCSF6-L	#6 AWG	#6 AWG	.31	1.75	Blue	P24	13/16	50
SCSF4-L	#4 AWG	#4 AWG	.38	1.75	Gray	P29	13/16	50
SCSF2-E	#2 AWG	#2 AWG	.47	1.87	Brown	P33	7/8	20
SCSF1-X	#1 AWG	#1 AWG	.52	1.87	Pink	P42	7/8	10
SCSF1/0-X	1/0 AWG	1/0 AWG	.58	2.50	Black	P45	1 3/16	10
SCSF2/0-X	2/0 AWG	2/0 AWG	.64	2.50	Orange	P50	1 3/16	10
SCSF3/0-X	3/0 AWG	3/0 AWG	.71	2.50	Purple	P54	1 3/16	10
SCSF4/0-X	4/0 AWG	4/0 AWG	.77	2.50	Yellow	P62	1 3/16	10
SCSF250-X	250 kcmil	262.6 kcmil	.88	2.50	White	P66	1 3/16	10
SCSF300-6	300 kcmil	313.1 kcmil	.95	2.56	Red	P71	1 1/4	6
SCSF350-6	350 kcmil	373.7 kcmil	1.06	2.94	Blue	P76	1 1/2	6

‡See pages L24, L25 in Technical Info section for tool and die information.

**Consult cable manufacturer for voltage stress relief instructions with applications greater than 2000 volts.

System Overview

Terminals

Disconnects

Splices

Ferrules

Compression Connectors

Crimping Tools

Mechanical Connectors

Grounding Connectors

Support Products

Technical Info

Index

System Overview

NEW! Code/Flex Conductor, with Window, In-Line Reducing Splice Kit

Type RSCK

Terminals

- Includes all components in one package for making a complete electrical connection: *PANDUIT®* Copper Compression RSC In-Line Reducing Splice ([See page F104](#)) and Crystal Clear PVC Heat Shrink sleeves pre-cut to length to insulate reducing splice ([See page K27](#))

- PANDUIT®* Crystal Clear PVC Heat Shrink is UL Recognized with a temperature rating of 150°C, high temperature insulating property
- Rated for 600V applications when *PANDUIT®* Crystal Clear PVC Heat Shrink is applied

Disconnects

- PANDUIT®* Crystal Clear PVC Heat Shrink has a UL 224 VW-1 flammability rating and passes Telcordia GR-347-CORE Compression and Cut-Through Penetration Test and Abrasion Resistance Test



Splices

Ferrules

Compression Connectors

Crimping Tools

Mechanical Connectors

Grounding Connectors

Support Products

Technical Info

Index

Part Number	Part Description	Std. Pkg. Qty.
RSCK4-6-1	Kit contains: 1 pc. RSC4-6-L copper compression in-line reducing splice. 1 pc. HSTTPN50-713-Q crystal clear PVC heat shrink 1/2" dia. x 7.125" long.	1
RSCK2-6-1	Kit contains: 1 pc. RSC2-6-Q copper compression in-line reducing splice. 1 pc. HSTTPN62-750-Q crystal clear PVC heat shrink 5/8" dia. x 7.500" long.	1
RSCK2-4-1	Kit contains: 1 pc. RSC2-4-Q copper compression in-line reducing splice. 1 pc. HSTTPN62-750-Q crystal clear PVC heat shrink 5/8" dia. x 7.500" long.	1
RSCK1/0-6-1	Kit contains: 1 pc. RSC1/0-6-X copper compression in-line reducing splice. 1 pc. HSTTPN75-775-Q crystal clear PVC heat shrink 3/4" dia. x 7.750" long. 1 pc. HSTTPN50-438-L crystal clear PVC heat shrink 1/2" dia. x 4.375" long.	1
RSCK1/0-4-1	Kit contains: 1 pc. RSC1/0-4-X copper compression in-line reducing splice. 1 pc. HSTTPN75-775-Q crystal clear PVC heat shrink 3/4" dia. x 7.750" long. 1 pc. HSTTPN50-438-L crystal clear PVC heat shrink 1/2" dia. x 4.375" long.	1
RSCK2/0-6-1	Kit contains: 1 pc. RSC2/0-6-X copper compression in-line reducing splice. 1 pc. HSTTPN75-775-Q crystal clear PVC heat shrink 3/4" dia. x 7.750" long. 1 pc. HSTTPN50-438-L crystal clear PVC heat shrink 1/2" dia. x 4.375" long.	1
RSCK2/0-4-1	Kit contains: 1 pc. RSC2/0-4-X copper compression in-line reducing splice. 1 pc. HSTTPN75-775-Q crystal clear PVC heat shrink 3/4" dia. x 7.750" long. 1 pc. HSTTPN50-438-L crystal clear PVC heat shrink 1/2" dia. x 4.375" long.	1
RSCK4/0-6-1	Kit contains: 1 pc. RSC4/0-6-X copper compression in-line reducing splice. 1 pc. HSTTPN100-775-Q crystal clear PVC heat shrink 1" dia. x 7.750" long. 1 pc. HSTTPN50-438-L crystal clear PVC heat shrink 1/2" dia. x 4.375" long.	1
RSCK4/0-4-1	Kit contains: 1 pc. RSC4/0-4-X copper compression in-line reducing splice. 1 pc. HSTTPN100-775-Q crystal clear PVC heat shrink 1" dia. x 7.750" long. 1 pc. HSTTPN50-438-L crystal clear PVC heat shrink 1/2" dia. x 4.375" long.	1

Code/Flex Conductor, with Window, In-Line Reducing Splice Kit (continued)

Part Number	Part Description	Std. Pkg. Qty.
RSC4/0-1/0-1	Kit contains: 1 pc. RSC4/0-1/0-X copper compression in-line reducing splice. 1 pc. HSTTPN100-775-Q crystal clear PVC heat shrink 1" dia. x 7.750" long. 1 pc. HSTTPN75-775-Q crystal clear PVC heat shrink 3/4" dia. x 7.750" long.	1
RSC4/0-2/0-1	Kit contains: 1 pc. RSC4/0-2/0-X copper compression in-line reducing splice. 1 pc. HSTTPN100-775-Q crystal clear PVC heat shrink 1" dia. x 7.750" long. 1 pc. HSTTPN75-775-Q crystal clear PVC heat shrink 3/4" dia. x 7.750" long.	1
RSC500-X4/0-1	Kit contains: 1 pc. RSC500-X4/0-6 copper compression in-line reducing splice. 1 pc. HSTTPN150-925-X crystal clear PVC heat shrink 1 1/2" dia. x 9.250" long.	1
RSC500-X350-1	Kit contains: 1 pc. RSC500-X350-6 copper compression in-line reducing splice. 1 pc. HSTTPN150-925-X crystal clear PVC heat shrink 1 1/2" dia. x 9.250" long.	1
RSC750-4/0-1	Kit contains: 1 pc. RSC750-4/0-6 copper compression in-line reducing splice. 1 pc. HSTTPN150-925-X crystal clear PVC heat shrink 1 1/2" dia. x 9.250" long. 1 pc. HSTTPN100-775-Q crystal clear PVC heat shrink 1" dia. x 7.750" long.	1
RSC750-X4/0-1	Kit contains: 1 pc. RSC750-X4/0-6 copper compression in-line reducing splice. 1 pc. HSTTPN150-925-X crystal clear PVC heat shrink 1 1/2" dia. x 9.250" long.	1
RSC750-X350-1	Kit contains: 1 pc. RSC750-X350-6 copper compression in-line reducing splice. 1 pc. HSTTPN150-925-X crystal clear PVC heat shrink 1 1/2" dia. x 9.250" long.	1
RSC750-500-1	Kit contains: 1 pc. RSC750-500-6 copper compression in-line reducing splice. 1 pc. HSTTPN150-925-X crystal clear PVC heat shrink 1 1/2" dia. x 9.250" long.	1
RSC750-X500-1	Kit contains: 1 pc. RSC750-X500-6 copper compression in-line reducing splice. 1 pc. HSTTPN150-925-X crystal clear PVC heat shrink 1 1/2" dia. x 9.250" long.	1
RSC750-750-1	Kit contains: 1 pc. RSC750-750-6 copper compression in-line reducing splice. 1 pc. HSTTPN150-925-X crystal clear PVC heat shrink 1 1/2" dia. x 9.250" long.	1
RSCX750-4/0-1	Kit contains: 1 pc. RSCX750-4/0-3 copper compression in-line reducing splice. 1 pc. HSTTPN200-950-X crystal clear PVC heat shrink 2" dia. x 9.500" long. 1 pc. HSTTPN100-775-Q crystal clear PVC heat shrink 1" dia. x 7.750" long.	1
RSCX750-750-1	Kit contains: 1 pc. RSCX750-750-3 copper compression in-line reducing splice. 1 pc. HSTTPN200-950-X crystal clear PVC heat shrink 2" dia. x 9.500" long.	1

System Overview

Terminals

Disconnects

Splices

Ferrules

Compression Connectors

Crimping Tools

Mechanical Connectors

Grounding Connectors

Support Products

Technical Info

Index

PANDUIT® TERMINATION SOLUTIONS

System Overview

NEW!



Code/Flex Conductor, with Window, In-Line Reducing Splice

For Use with Stranded Copper Code and Class I Flex Conductors

Terminals

Type RSC

- Low profile design provides minimum space requirements
- Manufactured from seamless, high conductivity copper tubing
- Color coded barrels marked with **PANDUIT®** and specified competitor die index numbers for proper crimp die selection
- Inspection windows in each barrel to visually assure full conductor insertion
- Generous internally beveled wire entry for easy conductor insertion
- Tin plated to inhibit corrosion
- UL Listed for use up to 35KV**, temperature rated 90°C and CSA Certified to 600V when crimped with **PANDUIT®** and specified competitor crimping tools and dies
- Also sold as a kit with crystal clear PVC heat shrink ([see pages F102, F103](#)).

Disconnects

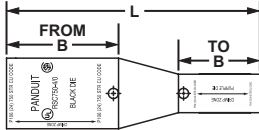

Splices

Part Number	Copper Conductor Size	Figure Dimension (In.)		PANDUIT® Color Code	PANDUIT® Die Index No.‡	Burdny Die Index No.‡	T&B Die Index No.‡	Wire Strip Length (In.)	Std. Pkg. Qty.
		B	L						
RSC4-6-L	Reduces From #4 AWG*	1.05	2.54	Gray	P29	8	29	1	1
	Reduces To #6 AWG	1.38		Blue	P24	7	24	1 5/16	
RSC2-6-Q	Reduces From #2 AWG	1.05	2.62	Brown	P33	10	33	1	1
	Reduces To #6 AWG	1.38		Blue	P24	7	24	1 5/16	
RSC2-4-Q	Reduces From #2 AWG	1.05	2.50	Brown	P33	10	33	1	1
	Reduces To #4 AWG*	1.38		Gray	P29	8	29	1 5/16	
RSC1/0-6-X	Reduces From 1/0 AWG	1.05	2.81	Pink	P42	12	42	1	1
	Reduces To #6 AWG	1.38		Blue	P24	7	24	1 5/16	
RSC1/0-4-X	Reduces From 1/0 AWG	1.05	2.70	Pink	P42	12	42	1	1
	Reduces To #4 AWG*	1.38		Gray	P29	8	29	1 5/16	
RSC2/0-6-X	Reduces From 2/0 AWG	1.13	2.99	Black	P45	13	45	1 1/16	1
	Reduces To #6 AWG	1.38		Blue	P24	7	24	1 5/16	
RSC2/0-4-X	Reduces From 2/0 AWG	1.13	2.88	Black	P45	13	45	1 1/16	1
	Reduces To #4 AWG*	1.38		Gray	P29	8	29	1 5/16	
RSC4/0-6-X	Reduces From 4/0 AWG	1.13	3.24	Purple	P54	15	54	1 1/16	1
	Reduces To #6 AWG	1.38		Blue	P24	7	24	1 5/16	
RSC4/0-4-X	Reduces From 4/0 AWG	1.13	3.12	Purple	P54	15	54	1 1/16	1
	Reduces To #4 AWG*	1.38		Gray	P29	8	29	1 5/16	
RSC4/0-1/0-X	Reduces From 4/0 AWG	1.16	3.13	Purple	P54	15	54	1 1/16	1
	Reduces To 1/0 AWG	1.63		Pink	P42	12	42	1 9/16	
RSC4/0-2/0-X	Reduces From 4/0 AWG	1.16	2.90	Purple	P54	15	54	1 1/16	1
	Reduces To 2/0 AWG	1.50		Black	P45	13	45	1 7/16	
RSC500-X4/0-6	Reduces From 500 kcmil	1.94	3.97	Brown	P87	20	87	1 7/8	1
	Reduces To 4/0 Flex	1.50		Yellow	P62	16	62	1 7/16	
RSC500-X350-6	Reduces From 500 kcmil	1.94	4.38	Brown	P87	20	87	1 7/8	1
	Reduces To 350 Flex	1.94		Blue	P76	19	76	1 7/8	
RSC750-4/0-6	Reduces From 750 kcmil	2.06	4.66	Black	P106	24	106	2	1
	Reduces To 4/0 AWG	1.50		Purple	P54	15	54	1 5/8	
RSC750-X4/0-6	Reduces From 750 kcmil	2.06	4.54	Black	P106	24	106	2	1
	Reduces To 4/0 Flex	1.50		Yellow	P62	16	62	1 7/16	
RSC750-X350-6	Reduces From 750 kcmil	2.06	4.45	Black	P106	24	106	2	1
	Reduces To 350 Flex	1.94		Blue	P76	19	76	1 7/8	
RSC750-500-6	Reduces From 750 kcmil	2.06	4.45	Black	P106	24	106	2	1
	Reduces To 500 kcmil	1.94		Brown	P87	20	87	1 7/8	
RSC750-X500-6	Reduces From 750 kcmil	2.06	4.63	Black	P106	24	106	2	1
	Reduces To 500 Flex	2.06		Pink	P99	400	99	2	
RSC750-750-6	Reduces From 750 kcmil	2.06	4.63	Black	P106	24	106	2	1
	Reduces To 750 kcmil	2.06		Black	P106	24	106	2	
RSCX750-4/0-3	Reduces From 750 Flex	2.06	5.04	Yellow	P115	115	115	2	1
	Reduces To 4/0 AWG	1.50		Purple	P54	15	54	1 5/8	
RSCX750-750-3	Reduces From 750 Flex	2.06	4.50	Yellow	P115	115	115	2	1
	Reduces To 750 kcmil	2.06		Black	P106	24	106	2	

Index

‡See [pages L26, L27, L28, L29, L30, L31](#) in Technical Info section for tool and die information.
 *Also UL Listed and CSA Certified for #3 AWG STR and #2 AWG SOL.
 **Consult cable manufacturer for voltage stress relief instructions with applications greater than 2000 volts.



Code Conductor, Thin Wall, CTAP

For Copper Code Stranded Connections

Type CTAPF

- For copper-to-copper tapping splicing or pigtailling
- Wire range-taking capability minimizes inventory requirements
- Color coded for proper crimp die selection
- Ribbed design provides high strength
- Made from high conductivity wrought copper
- UL Listed for use up to 600V, temperature rated 90°C and CSA Certified to 600V when crimped with PANDUIT® and specified competitor crimping tools and dies

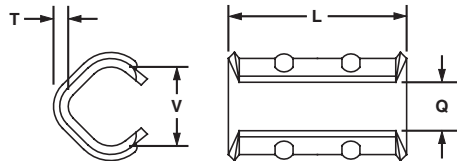

Part Number	Copper Conductor Size		No. of Ribs	Figure Dimensions (In.)				PANDUIT® Color Code	Wire Strip Length (In.)	Std. Pkg. Qty.
	Run	Tap		L	T	V	Q			
CTAPF10-16-C*	#14 AWG	#16 AWG – #14 AWG	0	.41	.06	.19	.13	Red	1/2	100
	#12 AWG	#16 AWG – #12 AWG								
	#10 AWG	#14 AWG								
CTAPF8-12-C	#10 AWG	#10 AWG	0	.67	.07	.26	.19	Blue	11/16	100
	#8 AWG	#12 AWG								
CTAPF6-12-C	#8 AWG	#10 AWG – #8 AWG	0	.67	.07	.32	.24	Gray	11/16	100
	#6 AWG	#12 AWG – #10 AWG								
CTAPF4-12-C	#6 AWG	#8 AWG – #6 AWG	1	1.25	.07	.40	.28	Brown	1 5/16	100
	#5 AWG, #4 AWG	#12 AWG – #8 AWG								
CTAPF3-12-C	#5 AWG, #4 AWG	#6 AWG – #5 AWG	1	1.25	.08	.46	.31	Green	1 5/16	100
	#3 AWG	#12 AWG – #6 AWG								
CTAPF2-12-C	#4 AWG	#4 AWG	1	1.25	.08	.51	.33	Pink	1 5/16	100
	#3 AWG	#5 AWG								
	#2 AWG	#12 AWG – #6 AWG								
CTAPF1-12-C	#3 AWG	#4 AWG – #3 AWG	2	1.82	.08	.57	.40	Black	1 7/8	100
	#2 AWG	#5 AWG – #4 AWG								
	#1 AWG	#12 AWG – #5 AWG								
CTAPF1/0-12-L	#2 AWG	#4 AWG – #2 AWG	2	1.82	.09	.63	.42	Orange	1 7/8	50
	#1 AWG	#4 AWG – #3 AWG								
	1/0 AWG	#12 AWG – #4 AWG								
CTAPF2/0-12-Q	#1 AWG	#2 AWG – #1 AWG	2	1.82	.09	.71	.48	Purple	1 7/8	25
	1/0 AWG	#3 AWG – #2 AWG								
	2/0 AWG	#12 AWG – #3 AWG								
CTAPF3/0-12-Q	1/0 AWG	#1 AWG – 1/0 AWG	2	1.82	.09	.81	.55	Yellow	1 7/8	25
	2/0 AWG	#2 AWG – #1 AWG								
	3/0 AWG	#12 AWG – #2 AWG								

‡See pages L32, L33 in Technical Info section for tool and die information.

*CTAPF10-16-C available with square, not flared ends.

System Overview

Terminals

Disconnects

Splices

Ferrules

Compression Connectors

Crimping Tools

Mechanical Connectors

Grounding Connectors

Support Products

Technical Info

Index

System Overview



Code Conductor, Heavy Duty, CTAP

For Use with Solid and Stranded Copper Code Conductors

Type CTAP

Terminals

- For tapping into unbroken continuous main, as a wire joint or 2-way splice
- Wire range-taking capability minimizes inventory requirements
- Made from heavy wall, extruded, high conductivity copper; provides high strength and premium electrical properties
- UL Listed per UL 486A for use up to 35KV** and temperature rated 90°C when crimped with *PANDUIT*® and specified competitor crimping tools and dies
- UL Listed per UL 467 for grounding and bonding suitable for direct burial in earth or concrete when crimped with *PANDUIT*® and specified competitor crimping tools and dies

Disconnects

Splices

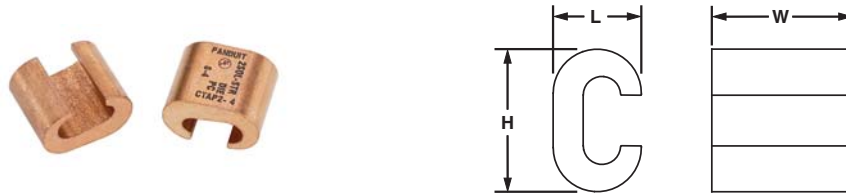

Ferrules

Part Number	Copper Conductor Size		Figure Dimensions (In.)			PANDUIT® Die Index No.‡	Burndy Die Index No.‡	Wire Strip Length (In.)	Tap Cover	Std. Pkg. Qty.
	Run	Tap	L	W	H					
CTAP4-8-L	#6 – #4 SOL or STR	#8 SOL or STR	.46	.63	.73	PBG	BG	3/4	TAPC2-2/0-X	50
CTAP4-6-L	#6 STR, #4 SOL or STR	#6 SOL or STR	.48	.63	.76	PBG	BG	3/4	TAPC2-2/0-X	50
CTAP4-4-L	#4 SOL or STR	#4 STR	.46	.63	.81	PBG	BG	3/4	TAPC2-2/0-X	50
CTAP2-4-Q	#2 SOL or STR	#8 – #4 SOL or STR	.60	.76	.96	PC	C	7/8	TAPC2-2/0-X	25
CTAP2-2-X	#2 SOL or STR	#2 SOL or STR	.60	.75	1.05	PC	C	7/8	TAPC2-2/0-X	10
CTAP2/0-2-X	1/0 – 2/0 STR	#8 – #2 SOL or STR	.80	.93	1.32	PO	O	1 1/16	TAPC2-2/0-X	10
CTAP2/0-2/0-X	1/0 – 2/0 STR	1/0 – 2/0 STR	.80	.93	1.37	PO	O	1 1/16	TAPC2-2/0-X	10
CTAP4/0-2-X	3/0 – 4/0 STR	#6 – #2 SOL or STR	.94	1.08	1.66	PD3	F	1 1/4	TAPC3/0-4/0-5	10
CTAP4/0-2/0-X	3/0 – 4/0 STR	1/0 – 2/0 STR	1.00	1.08	1.57	PD3	F	1 1/4	TAPC3/0-4/0-5	10
CTAP4/0-4/0-X	3/0 – 4/0 STR	3/0 – 4/0 STR	1.00	1.08	1.57	PD3	F	1 1/4	TAPC3/0-4/0-5	10

‡See [page L34](#) in Technical Info section for tool and die information.

**Consult cable manufacturer for voltage stress relief instructions with applications greater than 2000 volts.

Crimping Tools

Mechanical Connectors

Black Covers for Copper CTAPs and Aluminum HTAPs

Type TAPC

Grounding Connectors

- Used to insulate connectors and protect tap connections from corrosive environments
- Made of durable, weather-resistant black polypropylene
- Double locking latches provide secure cover installation
- Flexible molded fingers at end of covers conform to conductor and prevent foreign objects from contacting connector

Support Products

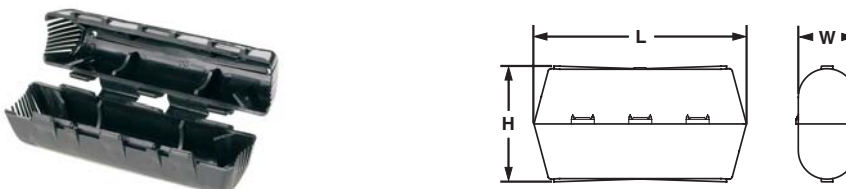

Technical Info

Part Number	Use with CTAP Part Number	Use with HTAP Part Number	Figure Dimensions (In.)			Std. Pkg. Qty.
			L	W	H	
TAPC2-2/0-X	CTAP 4-6, CTAP 4-4, CTAP 2-4, CTAP 2-2	HTAP 1-1, HTAP 1/0-1, HTAP 2-8, HTAP 2/0-1	4.62	1.60	2.22	10
TAPC3/0-4/0-5	CTAP 4/0-4/0	HTAP 3/0-1, HTAP 3/0-3/0, HTAP 4/0-2, HTAP 4/0-3/0, HTAP 4/0-4/0	5.65	1.72	2.38	5
TAPC500-2	—	HTAP 500-4/0, HTAP 500-500	6.81	2.86	2.38	2

For information on Aluminum HTAPS, see [page F118](#).

Index

NEW!



Code/Flex Conductor HTAP Kit

Type HTWC

- Includes all components to make a complete HTAP and cover installation: HTCT HTAP, matching CLRCVR clear cover and cable ties
- Each HTCT HTAP designed to terminate a wide range of copper code and flex conductor combinations to accommodate a variety of applications
- HTAPs incorporate a unique slotted design that allows for quick and easy installation using supplied *PANDUIT*® cable ties; saves time and cost
- Matching clear covers are made from high impact, optical grade plastic and provide high impact strength and 360° viewing of installed HTAP
- Clear covers have a UL 94 V-0 flame rating and an oxygen index of 28 providing self-extinguishing, flame retardant properties
- UL Listed and CSA Certified for applications up to 600V when crimped with *PANDUIT*® and specified competitor crimping tools and *PANDUIT*® crimp dies
- See [page G4](#) for detailed installation instructions



Part Number	Components		Copper Conductor Size Range					Std. Pkg. Qty.
	HTAP Part No.	Clear Cover Part No.	Wire Strand Type	Run	Tap 1	Tap 2	Tap 3	
HTWC8-8-1	HTCT8-8-1	CLRCVR1-1	Code	#8 – #14 AWG	#8 – #14 AWG	—	—	1
			Flex	#8 – #14 AWG	#8 – #14 AWG	—	—	
HTWC6-6-1	HTCT6-6-1	CLRCVR1-1	Code	#6 – #10 AWG	#6 – #14 AWG	—	—	1
			Flex	#6 – #10 AWG	#6 – #14 AWG	—	—	
HTWC2-2-1	HTCT2-2-1	CLRCVR2-1	Code	#2 – #6 AWG STR/SOL	#2 – #6 AWG STR/SOL	#8 – #14 AWG	#8 – #14 AWG	1
			Flex	#2 – #8 AWG	#2 – #8 AWG	#8 – #14 AWG	#8 – #14 AWG	
HTWC250-8-1	HTCT250-8-1	CLRCVR3-1	Code	250 kcmil – #2 AWG	#8 – #14 AWG	#8 – #14 AWG	—	1
			Flex	4/0 – #2 AWG	#8 – #14 AWG	#8 – #14 AWG	—	
HTWC250-2-1	HTCT250-2-1	CLRCVR3-1	Code	250 kcmil – #2 AWG	#2 – #6 AWG STR/SOL	#8 – #14 AWG	—	1
			Flex	4/0 – #2 AWG	#2 – #8 AWG	#8 – #14 AWG	—	
HTWC250-250-1	HTCT250-250-1	CLRCVR3-1	Code	250 kcmil – #2 AWG	250 kcmil – #2 AWG	—	—	1
			Flex	4/0 – #2 AWG	4/0 – #2 AWG	—	—	
HTWC500-250-1	HTCT500-250-1	CLRCVR5-1	Code	500 kcmil – 4/0 AWG	250 kcmil – 1/0 AWG	#1 – #6 AWG SOL	#8 – #14 AWG	1
			Flex	373 kcmil – 4/0 AWG	4/0 – 1/0 AWG	#1 – #8 AWG	#8 – #14 AWG	
HTWC500-500-1	HTCT500-500-1	CLRCVR5-1	Code	500 – 250 kcmil	500 kcmil – 4/0 AWG	—	—	1
			Flex	373 kcmil – 4/0 AWG	373 kcmil – 4/0 AWG	—	—	
HTWC750-4/0-1	HTCT750-4/0-1	CLRCVR6-1	Code	750 – 350 kcmil	4/0 – 1/0 AWG	#1 – #6 AWG STR/SOL	#2 – #14 AWG	1
			Flex	550 – 500 kcmil	250 kcmil – 1/0 AWG	#1 – #8 AWG	#2 – #14 AWG	
HTWC750-750-1	HTCT750-750-1	CLRCVR6-1	Code	750 – 500 kcmil	750 – 350 kcmil	—	—	1
			Flex	550 – 444 kcmil	550 – 313 kcmil	—	—	
HTWC1000-250-1	HTCT1000-250-1	CLRCVR6-1	Code	1000 – 750 kcmil	250 kcmil – 1/0 AWG	#1 – #2 AWG	—	1
			Flex	777 – 500 kcmil	4/0 – 1/0 AWG	#1 – #2 AWG	—	
HTWC1000-1000-1	HTCT1000-1000-1	CLRCVR6-1	Code	1000 – 750 kcmil	1000 – 750 kcmil	—	—	1
			Flex	777 – 500 kcmil	777 – 500 kcmil	—	—	
			Flex	777 – 750 kcmil	350 kcmil	—	—	

See [pages F108 and F109](#) for more information on HTAPs and clear covers.

System Overview

Terminals

Disconnects

Splices

Ferrules

Compression Connectors

Crimping Tools

Mechanical Connectors

Grounding Connectors

Support Products

Technical Info

Index

System Overview

NEW!



Code/Flex Conductor HTAP

For Making Parallel and Multiple Tap Connections on Code and Flex Conductors

Type HTCT

Terminals

- Used to tap into continuous conductors as a splice or pigtailling
- Each HTAP terminates a wide range of conductor sizes and combinations of code and flex conductors Class G, H, I and Locomotive to suit a variety of applications

- Color coded and marked with **PANDUIT®** die index numbers for proper crimp die selection
- UL Listed and CSA Certified for applications up to 600V when crimped with **PANDUIT®** and specified competitor crimping tools and **PANDUIT®** crimp dies

Disconnects

- Slotted design allows quick and easy assembly of conductor to HTAP using 3 **PANDUIT®** 94 V-0 cable ties included
- Tap grooves are separated from one another allowing them to function independently so HTAP can be used with a single or multiple taps providing maximum design and installation flexibility

- Tin plated to inhibit corrosion
- See [page G4](#) for detailed installation instructions

Splices



Ferrules

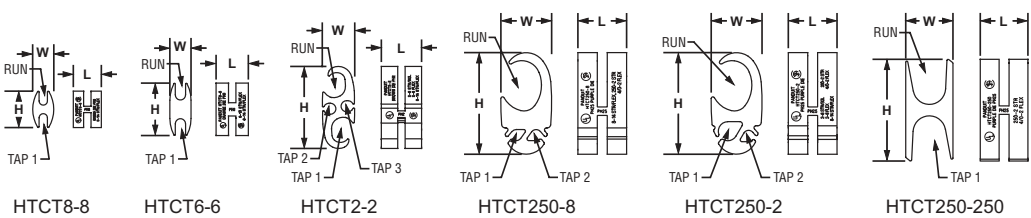

Compression Connectors

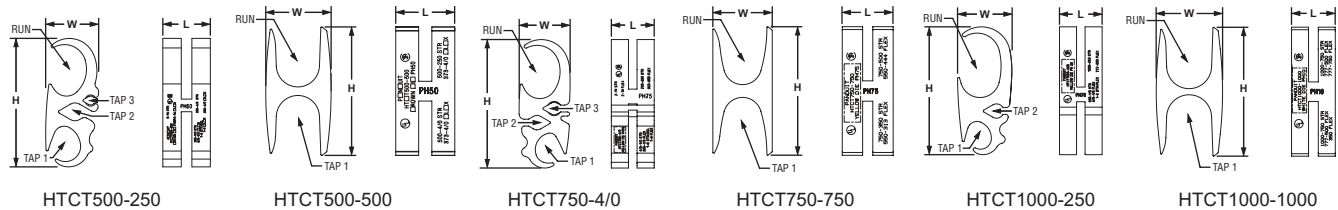

Crimping Tools

Part Number	Fig. No.	Copper Conductor Size Range					Figure Dimensions (In.)			PANDUIT® Color Code	PANDUIT® Die Index No.‡	Wire Strip Length (In.)	Std. Pkg. Qty.
		Wire Strand Type	Run	Tap 1	Tap 2	Tap 3	L	W	H				
HTCT8-8-1	1	Code	8 – 14	8 – 14	—	—	.53	.40	.69	Green	PH8	19/32	1
		Flex	8 – 14	8 – 14	—	—							
HTCT6-6-1	2	Code	6 – 10	6 – 14	—	—	.61	.40	.99	Orange	PH6	11/16	1
		Flex	6 – 10	6 – 14	—	—							
HTCT2-2-1	3	Code	2 – 6 STR/SOL	2 – 6 STR/SOL	8 – 14	8 – 14	.76	.61	1.55	Brown	PH2	13/16	1
		Flex	2 – 8	2 – 8	8 – 14	8 – 14							
HTCT250-8-1	4	Code	250 – 2	8 – 14	8 – 14	—	.92	.96	1.92	Purple	PH25	1	1
		Flex	4/0 – 2	8 – 14	8 – 14	—							
HTCT250-2-1	5	Code	250 – 2	2 – 6 STR/SOL	8 – 14	—	.92	.96	1.92	Purple	PH25	1	1
		Flex	4/0 – 2	2 – 8	8 – 14	—							
HTCT250-250-1	6	Code	250 – 2	250 – 2	—	—	.90	.89	1.92	Purple	PH25	1	1
		Flex	4/0 – 2	4/0 – 2	—	—							
HTCT500-250-1	7	Code	500 – 4/0	250 – 1/0	1 – 6 STR/SOL	8 – 14	1.12	1.25	3.03	Brown	PH50	1 1/4	1
		Flex	373 – 4/0	4/0 – 1/0	1 – 8	8 – 14							
HTCT500-500-1	8	Code	500 – 250	500 – 4/0	—	—	1.12	1.24	2.44	Brown	PH50	1 1/4	1
		Flex	373 – 4/0	373 – 4/0	—	—							
HTCT750-4/0-1	9	Code	750 – 350	4/0 – 1/0	1 – 6 STR/SOL	2 – 14	1.25	1.49	3.75	Yellow	PH75	1 3/8	1
		Flex	550 – 500	250 – 1/0	1 – 8	2 – 14							
HTCT750-750-1	10	Code	750 – 500	750 – 350	—	—	1.25	1.46	3.16	Yellow	PH75	1 3/8	1
		Flex	550 – 444	550 – 313	—	—							
HTCT1000-250-1	11	Code	1000 – 750	250 – 1/0	1 – 2	—	1.25	1.59	3.75	Yellow	PH75	1 3/8	1
		Flex	777 – 500	4/0 – 1/0	1 – 2	—							
HTCT1000-1000-1	12	Code	1000 – 750	1000 – 750	—	—	1.12	1.70	3.30	White	PH10	1 1/4	1
		Flex	777 – 500	777 – 500	—	—							
		Flex	777 – 750	350	—	—							

‡See [page L35](#) in Technical Info section for tool and die information.

NEW! Clear Covers for HTCT HTAPs

For Use with Solid and Stranded Copper Code Conductors

Type CLRCVR

- Made of high impact, optical grade plastic to provide high impact strength and 360° inspections of crimped connection to assure the crimp is complete and the correct die was used
- Incorporate dual self-latching spring loaded latches and supplied with two *PANDUIT*® UL 94 V-0 cable ties – allow for easy snap-on assembly and ensure covers are secured
- Low profile design minimizes space requirements
- Each cover half supports installation information labels inside plastic retainer strips to allow labels to be viewed on either side of cover and to protect labels from being removed
- Incorporate molded in flash barriers which encompass the HTAP installation providing protection against electrical flash over
- UL 94 V-0 flame rating and oxygen index of 28 providing self-extinguishing, flame retardant properties
- Part number, voltage rating, temperature rating and HTCT part number molded into cover for easy identification
- See [page G4](#) for detailed installation instructions

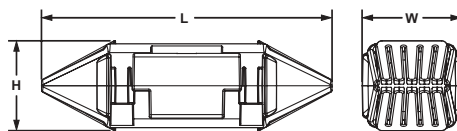

Shown Assembled

Part Number	Use with HTAP Part Number	Figure Dimensions (In.)			Std. Pkg. Qty.
		L	W	H	
CLRCVR1-1	HTCT8-8, HTCT6-6	4.48	1.41	1.20	1
CLRCVR2-1	HTCT2-2	5.10	1.66	1.40	1
CLRCVR3-1	HTCT250-8, HTCT250-2, HTCT250-250	5.35	2.16	1.40	1
CLRCVR5-1	HTCT500-250, HTCT500-500	7.50	3.10	1.90	1
CLRCVR6-1	HTCT750-4/0, HTCT750-750, HTCT1000-250, HTCT1000-1000	8.50	4.13	2.40	1

System Overview

Terminals

Disconnects

Splices

Ferrules

Compression Connectors

Crimping Tools

Mechanical Connectors

Grounding Connectors

Support Products

Technical Info

Index

System Overview

PANDUIT® Custom Copper Compression Lugs for Special Applications

Manufactured to meet your special dimensional specifications and requirements

Terminals

PANDUIT® has incorporated manufacturing processes that permit custom lug capabilities with premium two day or standard two week delivery. *PANDUIT®* offers a wide variety of dimensional choices for #8 AWG to 250 kcmil copper code lugs and #8 AWG to 4/0 AWG copper flex lugs.

Options:

Disconnects

Tongues — Straight or Bent
— Stacking
— Special Lengths

Splices

Stud Holes — Various Sizes, #10 to 1/2"
— Multiple Hole Sizes and Spacing
— Special Locations

Ferrules

Barrels — Three Standard Lengths: Short, Standard and Long
— Custom Lengths

With Dependable *PANDUIT®* Service

- **Excellent Quality**
- **Fast Delivery**
- **Low Minimum Order Quantities**
- **Competitive Prices**



Compression Connectors

Crimping Tools

Mechanical Connectors

Grounding Connectors

Support Products

Technical Info

Index

Custom Lugs Spec Sheet Instructions

Use these instructions to design your own custom lugs. Fill in the Custom Lugs Preliminary Spec Sheet to place your custom lugs order. You can copy the sheet from [page F112](#) or download it at www.panduit.com/customlugs.

- Fill out this section completely.
- Check the conductor size and type (Code or Flex). Fill in the strand designation and type for flex conductor.
- Check a barrel length. Refer to Chart "A" for standard barrel length dimensions. If the length you require is not listed, fill in the special box with your required length.
- Check "YES" if an inspection hole is required; check "NO" if it is not required.
- Check the barrel end type you require.
- Check a stud size and tongue style (one-hole, two-hole or blank). Refer to Chart "A" and Chart "B" for standard tongue dimensions. If you require tongue dimensions other than those listed, fill in the box that corresponds to the feature that requires a special dimension. You must fill in a hole spacing on two-hole lugs and tongue length on blank tongue lugs.

NOTE: Steps 7 and 8 are for bent or stacking lugs ONLY.

- Check the stacking lug you require. If both upper and lower lugs are required, check "both". (2 drawings will be provided.) If you choose a bent stacking lug, fill in the required angle.
- Check the bent lug you require. If you check "special angle", fill in the required angle.
- Check the special options you require. Fill in any blank lines that correspond to the option you've selected.
- Fax or mail the completed spec sheet to PANDUIT® Corp. Address and phone/fax numbers are listed on the bottom of the Custom Lugs Preliminary Spec Sheet (see [page F112](#) or go to www.panduit.com/customlugs). PANDUIT® will send drawings for your approval.

Chart "A"

Code Conductor Size	Locomotive Flex Conductor Size	Flex Conductor Size	Barrel		Barrel Length			Tongue Width				
			I.D.	O.D.	Short	Standard	Long	Nominal Stud Size				
								#10	1/4	5/16	3/8	1/2
#8	37/24	—	.18	.27	.42	.56	.70	.41	.48	.56	.60	—
#6	61/24	#6	.22	.31	.48	.81	1.07	.45	.48	.56	.62	—
#4	105/24	#4	.28	.38	.53	.81	1.05	.55		.62		—
#2	—	—	.31	.42	.57	.88	1.16	.60		.66		.75
#1	150/24	#2	.36	.47	.59	.88	1.36	.70			.75	
1/0	225/24	#1	.39	.52	.66	.94	1.44	.76			.80	
2/0	275/24	1/0	.45	.58	.72	.98	1.50	.85				
3/0	325/24	2/0	.51	.64	.83	1.14	1.50	.96				
4/0	450/24	3/0	.57	.71	.91	1.19	1.56	1.06				
250	550/24	4/0	.63	.77	1.03	1.25	1.61	1.17				

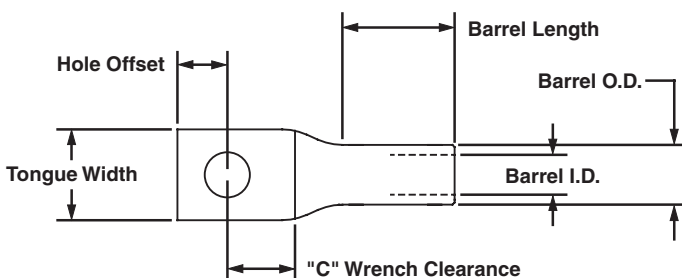

Chart "B"

Nominal Stud Size	Actual Hole Size	Minimum Hole Offset	Minimum "C" Wrench Size
#10	.20	.23	.31
1/4"	.27	.25	.38
5/16"	.34	.32	.38
3/8"	.41	.38	.44
1/2"	.53	.50	.56
5/8"	.69	.63	.69
3/4"	.81	.75	.75

System Overview

Custom Lugs Preliminary Spec Sheet

Photocopy this form to place your order. This form is also available at www.panduit.com/customlugs.
Mail or fax the photocopy to receive drawings and quotation. Place your order through your local PANDUIT® distributor.

Terminals

1 CUSTOMER PROFILE

Company Name _____
 Address _____ City/State _____
 Your Name _____ Phone Number _____
 Fax Number _____ Quantity Required _____ Delivery Date _____

Disconnects

2 CONDUCTOR

#8 #6 #4
 #2 #1 1/0
 2/0 3/0 4/0
 250 _____
 Kcmil Special

Code
 Flex

{ Strands _____
 Type _____

3 BARREL LENGTH

SHORT
 STANDARD
 LONG
 SPECIAL

4 INSPECTION HOLE

INSPECTION HOLE

YES NO

5 BARREL END TYPE

STANDARD
 CORONA RELIEF
 FLARED

Splices

Ferrules

6 TONGUE SPECIFICATIONS (Standard Dimensions apply to boxes left blank— See Charts "A" & "B")

Stud Sizes
 #10 1/4
 5/16 3/8
 1/2

Other _____

One-Hole Two-Hole Blank

Compression Connectors

Crimping Tools

7 STACKING LUG SELECTION (If not needed — proceed to Step 8)

Lugs With 0° to 45° Angles

Upper Bent _____ Angle Upper Bent _____ Angle
 Both
 Lower Bent _____ Angle Lower Bent _____ Angle

Mechanical Connectors

Grounding Connectors

8 BENT LUG SELECTION (If not needed — proceed to Step 9)

45° 90° SPECIAL ANGLE _____
 45° 90° SPECIAL ANGLE _____

Support Products

Technical Info

9 SPECIAL OPTIONS FEATURES

Part I.D. on Tongue PANDUIT® P/N
 Custom P/N: _____
 Heavy Wall Tube _____ I.D. _____ O.D.
 No Barrel Markings
 Special Plating (TIN STD): _____
 Special Packaging _____ PCS/BOX
 Other _____

10 MAILING/FAX DIRECTIONS

Fax to PANDUIT® Corp.
 PHONE: 888-506-5400 Ext. 2241 FAX: 815-485-5839 ATTN: Product Management **CONTACT FACTORY FOR MINIMUM ORDER**



Code Conductor, One-Hole, Aluminum Lug

For Use with Stranded Aluminum or Copper Code Conductors

Type LAA

- Manufactured from high conductivity thick wall wrought aluminum
- Factory pre-filled with joint compound and sealed with easy pull-out end plug to inhibit corrosion
- Color coded end plug and PANDUIT® and specified competitor die index numbers marked on barrel for proper crimp die selection
- Enclosed barrel prevents corrosive material from entering barrel when used in harsh environments
- Tin plated to inhibit corrosion
- UL Listed for use up to 35KV**, temperature rated 90°C and CSA Certified to 600V when crimped with PANDUIT® and specified competitor crimping tools and dies

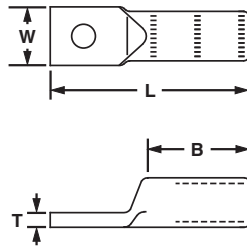

Part Number	Aluminum or Copper Conductor Size	Stud Hole Size (In.)	Figure Dimensions (In.)				PANDUIT® Color Code	PANDUIT® Die Index No.‡	Burdny Die Index No.‡	T&B Die Index No.‡	Wire Strip Length (In.)	Std. Pkg. Qty.
			W	B	T	L						
LAA6-14-X	#6 AWG	1/4	.55	.86	.11	2.20	Gray	P29	346	29	1	10
LAA6-56-X		5/16	.55	1.00	.11	2.20	Gray	P29	346	29	1	10
LAA4-14-X	#4 AWG	1/4	.66	1.05	.19	2.05	Green	P37	375	37	1 1/16	10
LAA4-56-X		5/16	.69	1.08	.16	2.23	Green	P37	375	37	1 1/16	10
LAA4-38-X		3/8	.69	.92	.16	2.33	Green	P37	375	37	1 1/16	10
LAA2-14-X	#2 AWG	1/4	.75	.98	.17	2.63	Pink	P42	348	42	1	10
LAA2-56-X		5/16	.75	.98	.17	2.63	Pink	P42	348	42	1	10
LAA2-38-X		3/8	.75	.98	.17	2.63	Pink	P42	348	42	1	10
LAA1-14-X	#1 AWG	1/4	.75	.98	.17	2.63	Gold	P45	471	45	1	10
LAA1-56-X		5/16	.75	.98	.17	2.63	Gold	P45	471	45	1	10
LAA1-38-X		3/8	.75	.98	.17	2.63	Gold	P45	471	45	1	10
LAA1/0-56-X	1/0 AWG	5/16	.88	1.30	.25	3.23	Tan	P50	296	50	1 9/16	10
LAA1/0-38-X		3/8	.88	1.30	.25	3.23	Tan	P50	296	50	1 9/16	10
LAA1/0-12-X		1/2	.88	1.30	.25	3.23	Tan	P50	296	50	1 9/16	10
LAA2/0-38-5	2/0 AWG	3/8	.95	1.31	.23	3.19	Olive	P54	297	54	1 7/16	5
LAA2/0-12-5		1/2	.95	1.30	.23	3.19	Olive	P54	297	54	1 7/16	5
LAA3/0-38-5	3/0 AWG	3/8	1.07	1.50	.25	3.44	Ruby	P60	467	60	1 9/16	5
LAA3/0-12-5		1/2	1.07	1.50	.25	3.44	Ruby	P60	467	60	1 9/16	5
LAA4/0-38-5	4/0 AWG	3/8	1.19	1.44	.32	3.56	White	P66	298	66	1 9/16	5
LAA4/0-12-5		1/2	1.19	1.44	.32	3.56	White	P66	298	66	1 9/16	5
LAA250-38-5	250 kcmil	3/8	1.24	1.56	.30	3.63	Red	P71	324	71	1 3/4	5
LAA250-12-5		1/2	1.24	1.56	.30	3.63	Red	P71	324	71	1 3/4	5
LAA300-38-2	300 kcmil	3/8	1.38	2.25	.34	4.05	Blue	P76	470	76	2 5/16	2
LAA300-12-2		1/2	1.38	2.25	.34	4.05	Blue	P76	470	76	2 5/16	2
LAA350-12-2	350 kcmil	1/2	1.50	2.25	.38	4.30	Brown	P87	299	87	2 5/16	2
LAA400-58-2	400 kcmil	5/8	1.63	2.50	.41	4.92	Green	P94	472	94	2 9/16	2
LAA500-12-2	500 kcmil	1/2	1.75	3.00	.44	5.56	Pink	P99	300	99	3 1/16	2
LAA500-58-2		5/8	1.75	3.00	.44	5.56	Pink	P99	300	99	3 1/16	2
LAA750-58-1	750 kcmil	5/8	1.75	3.38	.53	6.55	Red	P125	301	115	3 7/16	1
LAA1000-58-1	1000 kcmil	5/8	2.56	4.50	.61	7.38	Brown	P161	302	161	4 3/4	1

‡See pages L40, L41 in Technical Info section for tool and die information.

**Consult cable manufacturer for voltage stress relief instructions with applications greater than 2000 volts.

See pages H33, F118 for PANDUIT® joint compounds recommended for pad to pad and conductor connections.

System Overview

Terminals

Disconnects

Splices

Ferrules

Compression Connectors

Crimping Tools

Mechanical Connectors

Grounding Connectors

Support Products

Technical Info

Index

System Overview



Code Conductor, Two-Hole, Aluminum Lug

For Use with Stranded Aluminum or Copper Code Conductors

Type LAB

Terminals

- Manufactured from high conductivity thick wall wrought aluminum
- Factory pre-filled with joint compound and sealed with easy pull-out end plug to inhibit corrosion
- Color coded end plug and PANDUIT® and specified competitor die index numbers marked on barrel for proper crimp die selection
- Enclosed barrel prevents corrosive material from entering barrel when used in harsh environments
- Tin plated to inhibit corrosion
- UL Listed for use up to 35KV**, temperature rated 90°C and CSA Certified to 600V when crimped with PANDUIT® and specified competitor crimping tools and dies
- Available with NEMA hole sizes and spacing

Disconnects

Splices

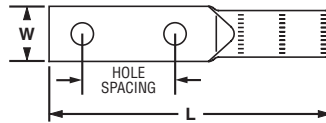

Ferrules

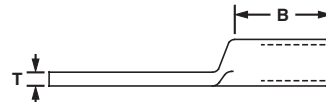

Part Number	Aluminum or Copper Conductor Size	Stud Hole Size (In.)	Stud Hole Spacing (In.)	Figure Dimensions (In.)				PANDUIT® Color Code	PANDUIT® Die Index No.	Burndy Die Index No.‡	T&B Die Index No.‡	Wire Strip Length (In.)	Std. Pkg. Qty.
				W	B	T	L						
LAB1/0-38-X	1/0 AWG	3/8	1.75	.88	1.55	.25	5.33	Tan	P50	296	50	1 9/16	10
LAB2/0-12-5	2/0 AWG	1/2	1.75	.94	1.55	.25	5.55	Olive	P54	297	54	1 9/16	5
LAB3/0-12-5	3/0 AWG	1/2	1.75	1.03	1.55	.27	5.55	Ruby	P60	467	60	1 9/16	5
LAB4/0-12-5	4/0 AWG	1/2	1.75	1.19	1.80	.31	5.98	White	P66	298	66	1 3/4	5
LAB250-12-5	250 kcmil	1/2	1.75	1.25	1.80	.31	6.05	Red	P71	324	71	1 3/4	5
LAB300-12-2	300 kcmil	1/2	1.75	1.36	2.30	.34	6.61	Blue	P76	470	76	2 5/16	2
LAB350-12-2	350 kcmil	1/2	1.75	1.50	2.30	.38	6.61	Brown	P87	299	87	2 5/16	2
LAB400-12-2	400 kcmil	1/2	1.75	1.66	2.55	.38	6.92	Green	P94	472	94	2 9/16	2
LAB500-12-2	500 kcmil	1/2	1.75	1.72	3.05	.44	7.36	Pink	P99	300	99	3 1/16	2
LAB600-12-2	600 kcmil	1/2	1.75	1.72	3.05	.50	7.55	Black	P106	473	106	3 1/16	2
LAB750-12-1	750 kcmil	1/2	1.75	1.72	3.42	.56	8.30	Red	P125	301	115	3 7/16	1
LAB800-12-1	800 kcmil	1/2	1.75	1.72	3.42	.59	8.30	Gray	P140	474	125	3 7/16	1
LAB1000-12-1	1000 kcmil	1/2	1.75	2.56	4.67	.63	9.67	Brown	P161	302	161	4 3/4	1

‡See [pages L40, L41](#) in Technical Info section for tool and die information.

**Consult cable manufacturer for voltage stress relief instructions with applications greater than 2000 volts.

See [pages H33, F118](#) for PANDUIT® joint compounds recommended for pad to pad and conductor connections.

◆NEMA hole sizes and spacing

Grounding Connectors

Support Products

Technical Info

Index

Belleville Compression Washers

Type CW

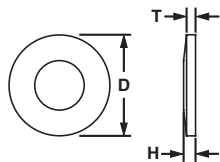

- Conical spring washer for use when assembling aluminum connectors to copper and/or steel pads, compensates for differing rates of thermal expansion to keep hardware assembly from loosening
- Made from hardened steel to provide high strength
- Cadmium plated to inhibit corrosion

Part Number	Stud Hole Size (In.)	Figure Dimensions (In.)			Std. Pkg. Qty.
		D	H	T	
CW-14-L	1/4	.68	.09	.05	50
CW-56-L	5/16	.81	.08	.06	50
CW-38-L	3/8	.93	.10	.07	50
CW-12-Q	1/2	1.18	.12	.09	25
CW-58-Q	5/8	1.49	.15	.12	25



Code Conductor, Aluminum Splice

For Use with Stranded Aluminum – to – Aluminum or Copper – to – Copper Conductors

Type SA

- Manufactured from high conductivity thick wall wrought aluminum
- Factory pre-filled with joint compound and sealed with easy pull-out end plug to inhibit corrosion
- Color coded end plugs and PANDUIT® and specified competitor die index numbers marked on barrel for proper crimp die selection
- Tin plated to inhibit corrosion
- Internal solid center prevents over-insertion of conductor
- UL Listed for use up to 35KV**, temperature rated 90°C and CSA Certified to 600V when crimped with PANDUIT® and specified competitor crimping tools and dies

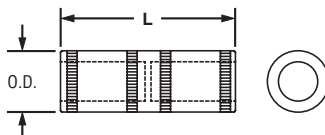

Part Number	Aluminum or Copper Conductor Size	Figure Dimensions (In.)		PANDUIT® Color Code	PANDUIT® Die Index No.‡	Burndy Die Index No.‡	T&B Die Index No.‡	Wire Strip Length (In.)	Std. Pkg. Qty.
		Barrel O.D.	L						
SA6-X	#6 AWG	.34	1.62	Gray	P29	346	29	3/4	10
SA4-X	#4 AWG	.48	2.13	Green	P37	375	37	7/8	10
SA2-X	#2 AWG	.53	2.00	Pink	P42	348	45	7/16	10
SA1-X	#1 AWG	.53	2.00	Gold	P45	471	45	7/16	10
SA1/0-X	1/0 AWG	.64	2.12	Tan	P50	296	50	1	10
SA2/0-5	2/0 AWG	.69	2.31	Olive	P54	297	54	1 1/8	5
SA3/0-5	3/0 AWG	.76	2.62	Ruby	P60	467	60	1 1/4	5
SA4/0-5	4/0 AWG	.88	2.75	White	P66	298	66	1 5/16	5
SA250-5	250 kcmil	.91	2.94	Red	P71	324	71	1 7/16	5
SA300-2	300 kcmil	1.01	3.12	Blue	P76	470	76	1 1/2	2
SA350-2	350 kcmil	1.12	3.37	Brown	P87	299	87	1 5/8	2
SA400-2	400 kcmil	1.19	3.75	Green	P94	472	94	1 13/16	2
SA500-2	500 kcmil	1.32	3.87	Pink	P99	300	99	1 7/8	2
SA600-2	600 kcmil	1.44	4.12	Black	P106	473	106	2	2
SA750-1	750 kcmil	1.60	4.62	Red	P125	301	115	2 1/4	1
SA800-1	800 kcmil	1.66	4.75	Gray	P140	474	125	2 5/16	1
SA1000-1	1000 kcmil	1.84	5.25	Brown	P161	302	161	2 9/16	1

‡See [pages L40, L41](#) in Technical Info section for tool and die information.

**Consult cable manufacturer for voltage stress relief instructions with applications greater than 2000 volts.

See [pages H33, F118](#) for PANDUIT® joint compounds recommended for pad to pad and conductor connections.

System Overview

Code Conductor, Aluminum Reducing Splice

For Reducing Stranded Aluminum – to – Aluminum or Aluminum – to – Copper Conductors

Terminals

Type SAR

- Dual rated for use with aluminum or copper conductors
- Factory pre-filled with joint compound and sealed with easy pull-out end plug to inhibit corrosion
- Color coded end plug and *PANDUIT*® and specified competitor die index numbers marked on barrel for proper crimp die selection
- Tin plated to inhibit corrosion
- For use up to 35KV** and temperature rated 90°C when crimped with *PANDUIT*® and specified competitor crimping tools and dies

Disconnects



Splices

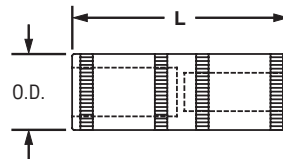

Ferrules

Part Number	Aluminum Conductor Size From	Aluminum or Copper Conductor Size To	Figure Dimensions (In.)		<i>PANDUIT</i> ® Color Code	<i>PANDUIT</i> ® Die Index No.‡	Burdny Die Index No.‡	T&B Die Index No.‡	Wire Strip Length (In.)	Std. Pkg. Qty.
			Barrel O.D.	L						
SAR2-4-X	#2 AWG	#4 AWG	.64	4.25	Tan	P50	296	50	2 1/16	10
SAR1/0-2-X	1/0 AWG	#2 AWG	.64	4.25	Tan	P50	296	50	2 1/16	10
SAR3/0-1/0-5	3/0 AWG	1/0 AWG	.91	4.98	Red	P71	324	71	2 3/16	5
SAR4/0-2/0-5	4/0 AWG	2/0 AWG	.91	5.24	Red	P71	324	71	2 3/16	5
SAR350-4/0-2	350 kcmil	4/0 AWG	1.12	6.63	Brown	P87	299	87	3 3/16	2
SAR500-350-2	500 kcmil	350 kcmil	1.32	8.60	Pink	P99	300	99	4 3/16	2
SAR600-500-2	600 kcmil	500 kcmil	1.49	9.25	Black	P106	473	106	4	2
SAR750-600-2	750 kcmil	600 kcmil	1.60	9.88	Red	P125	301	115	4 5/16	2

Compression Connectors

Crimping Tools

‡See [page L36](#) in Technical Info section for tool and die information.
 **Consult cable manufacturer for voltage stress relief instructions with applications greater than 2000 volts.
 See [pages H33, F118](#) for *PANDUIT*® joint compounds recommended for pad to pad and conductor connections.

Mechanical Connectors

Grounding Connectors

Support Products

Technical Info

Index



Code Conductor, Aluminum Bi-Metallic Pin Connector

Provides Copper Pigtail for Connecting Aluminum Conductors to a Copper or Aluminum/Copper Rated Mechanical Lug

Type BPC

- Factory pre-filled with joint compound and sealed with easy pull-out end plug to inhibit corrosion
- Color coded end plug and **PANDUIT®** die index number marked on barrel for proper crimp die selection
- Insulating rubber sleeve included to insulate aluminum barrel from contact with copper connector when attached to pin
- Tin plated to inhibit corrosion
- UL Listed per UL 486B; temperature rated 90°C and for use up to 600V when crimped with **PANDUIT®** and specified competitor crimping tools and dies

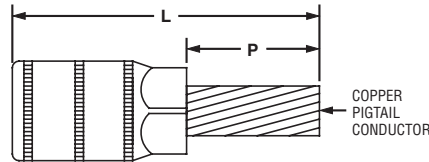

Part Number	Aluminum Conductor Size	Copper Pigtail Size	Figure Dimensions (In.)		PANDUIT® Color Code	PANDUIT® Die Index No.‡	Burdny Die Index No.‡	T&B Die Index No.‡	Wire Strip Length (In.)	Std. Pkg. Qty.
			L	P						
BPC6-L	#6 AWG	#8 AWG	2.45	.88	Tan	P50	296	50	1	50
BPC4-L	#4 AWG	#6 AWG	2.45	.88	Tan	P50	296	50	1	50
BPC2-L	#2 AWG	#4 AWG	2.45	.88	Tan	P50	296	50	1	50
BPC1-X	#1 AWG	#3 AWG	2.58	1.00	Tan	P50	296	50	1	10
BPC1/0-X	1/0 AWG	#2 AWG	3.33	1.25	Red	P71	298	76	1 1/4	10
BPC2/0-X	2/0 AWG	#1 AWG	3.33	1.25	Red	P71	298	76	1 1/4	10
BPC3/0-X	3/0 AWG	1/0 AWG	3.46	1.38	Red	P71	298	76	1 1/4	10
BPC4/0-X	4/0 AWG	2/0 AWG	3.46	1.38	Red	P71	298	76	1 1/4	10
BPC250-X	250 kcmil	3/0 AWG	3.71	1.50	Green	P94	299	99,87	1 3/8	10
BPC300-X	300 kcmil	4/0 AWG	4.10	1.63	Green	P94	299	99,87	1 3/8	10
BPC350-X	350 kcmil	4/0 AWG	4.10	1.63	Green	P94	299	99,87	1 3/8	10
BPC400-X	400 kcmil	250 kcmil	4.35	1.88	Black	P106	300	106	1 3/8	10
BPC500-X	500 kcmil	350 kcmil	4.35	1.88	Black	P106	300	106	1 3/8	10
BPC600-6	600 kcmil	350 kcmil	4.77	1.88	Red	P125	936	115	1 13/16	6
BPC750-6	750 kcmil	500 kcmil	4.90	2.00	Red	P125	936	115	1 13/16	6

‡See [pages L38, L39](#) in Technical Info section for tool and die information.
See [pages H33, F118](#) for **PANDUIT®** joint compounds recommended for pad to pad and conductor connections.

System Overview

Terminals

Disconnects

Splices

Ferrules

Compression Connectors

Crimping Tools

Mechanical Connectors

Grounding Connectors

Support Products

Technical Info

Index

System Overview

Code Conductor, Aluminum HTAP

For Combinations of Aluminum – to – Aluminum or Aluminum – to – Copper Code Conductors

Terminals

Type HTAP

- Dual rated — used to tap into continuous runs of aluminum conductor with either aluminum or copper tap conductor
- Factory pre-filled with joint compound to inhibit corrosion
- Conductor range for each tap groove and die index number marked on barrel to identify proper conductor size and crimp die to be used
- Made from high conductivity, high strength aluminum to provide premium mechanical and electrical performance
- For use up to 600V and 90°C temperature rated when crimped with PANDUIT® crimping tools and dies

Disconnects

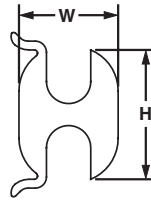
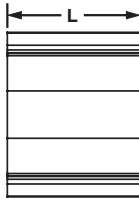
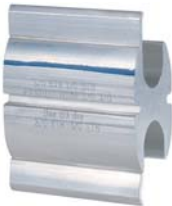

Splices

Ferrules

Part Number	Conductor Size		Figure Dimensions (In.)			PANDUIT® Die Index No.‡	Wire Strip Length (In.)	Std. Pkg. Qty.
	Run	Tap	L	W	H			
HTAP2-8-L	#2 – #6 AWG STR or #1 – #6 AWG SOL	#8 – #14 AWG STR or #7 – #14 AWG SOL	.75	.56	.73	P50	1 7/8	50
HTAP1-1-Q	#1 – #6 AWG STR or #2 – #6 AWG SOL	#1 – #6 AWG STR or #2 – #6 AWG SOL	1.50	.70	1.10	P0	1 5/8	25
HTAP1/0-1-Q	1/0 – #6 AWG STR or #2 – #6 AWG SOL	#1 – #6 AWG STR or #2 – #6 AWG SOL	1.50	.70	1.17	P0	1 5/8	25
HTAP2/0-1-Q	2/0 – #2 AWG STR or #2 AWG SOL	#1 – #6 AWG STR or #2 – #6 AWG SOL	1.50	.70	1.17	P0	1 5/8	25
HTAP3/0-1-Q	3/0 – 1/0 AWG STR or 4/0 – 3/0 AWG SOL	#1 – #6 AWG STR or #2 – #6 AWG SOL	1.50	.88	1.39	PD or PD3	1 5/8	25
HTAP3/0-3/0-Q	3/0 – 1/0 AWG STR or 4/0 – 3/0 AWG SOL	3/0 – 1/0 AWG STR or 4/0 – 3/0 AWG SOL	1.88	.90	1.48	PD or PD3	2	25
HTAP4/0-2-Q	4/0 – 3/0 AWG STR	#1 – #6 AWG STR or #2 – #6 AWG SOL	1.50	.88	1.38	PD or PD3	1 5/8	25
HTAP4/0-3/0-Q	4/0 – 3/0 AWG STR	3/0 – #1 AWG STR	2.25	.90	1.44	PD or PD3	2 3/8	25
HTAP4/0-4/0-Q	4/0 – 3/0 AWG STR	4/0 – 3/0 AWG STR	2.50	.90	1.38	PD or PD3	2 5/8	25
HTAP500-500-X	500 kcmil – 4/0 AWG STR	500 kcmil – 4/0 AWG STR	4.50	1.20	1.88	PN	4 5/8	10
HTAP500-4/0-X	500 kcmil – 4/0 AWG STR	4/0 – 1/0 AWG STR	2.75	1.20	1.88	PN	2 7/8	10

‡See [page L37](#) in Technical Info section for tool and die information.
 See [page F106](#) for Type TAPC HTAP covers.
 See below for PANDUIT® joint compounds recommended for pad to pad and conductor connections.

Grounding Connectors

Joint Compounds

Type CMP

- Oxide inhibitor for compression conductor connections made with aluminum compression connectors lowers electrical contact resistance of compression joint while sealing out air and moisture to prevent the formation of surface oxides
- Wide operating temperature range; can be used in a wide range of electrical and environmental conditions
- Non-toxic
- Non-flammable
- Packaged in convenient 8 oz. dispenser bottles

Support Products

Technical Info



Part Number	Part Description	Std. Pkg. Qty.
CMP-100-1	Contact aid for pad-to-pad or thread-to-thread aluminum connections. Operating temperature range -60°F (-51°C) to 400°F (204°C). Maintains low electrical resistance and seals out air and moisture to prevent the formation of surface oxides.	1
CMP-200-1	Contact aid for cable connections with compression connections made on aluminum conductor. Operating temperature range -40°F (-40°C) to 400°F (204°C). Lowers contact resistance of compression joint and seals out moisture and air to prevent the formation of surface oxides. Compatible with all insulating materials.	1

Index

CRIMPING TOOLS

PANDUIT® offers a wide range of tools to provide solutions for installing terminals, disconnects, splices and lugs. PANDUIT® installation tools provide quality performance, ease of installation and lowest installed cost. The long-term reliability of PANDUIT® installation tools provides the highest level of service to meet and surpass customer requirements.



- Ergonomic design to minimize operator effort
- Compression tools provide UL Listed and CSA Certified terminations with PANDUIT® electrical connectors, as noted
- Compression tools feature controlled cycle mechanisms ensuring reliability and repeatability in every crimp made
- Crimping dies are color coded to easily match the electrical connector to the proper die

PANDUIT® tools are available in an assortment of styles including manually operated mechanical and hydraulic, battery operated hydraulic, AC powered hydraulic and pneumatic to meet a variety of installation needs. Hand operated *CONTOUR CRIMP™* Controlled Cycle Crimping Tools feature ergonomically designed cushioned grips and low handle effort. *UNI-DIE™* Dieless Crimping Tools crimp a variety of sizes and eliminate the need to purchase crimping dies. Fully self-contained battery powered crimping tools provide the ease of push button crimping. PANDUIT® crimping tools are designed for use with PANDUIT® electrical connectors, providing the right solution for your termination needs.

System Overview

Terminals

Disconnects

Splices

Ferrules

Compression Connectors

Crimping Tools

Mechanical Connectors

Grounding Connectors

Support Products

Technical Info

Index

System Overview

Crimping Guidelines for PANDUIT® PAN-TERM® Terminals, Disconnects, Splices and Wire Joints

Terminals

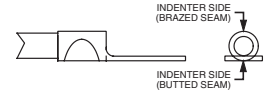
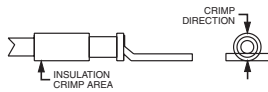

Insulated Terminals and Disconnects

1. Locate terminal in proper size crimp die with edge of die 1/16" from the tongue end of the insulation sleeve (See Note 1 below). Ensure that crimp is perpendicular to the plane of the terminal tongue, as shown.
2. Insert properly stripped wire into terminal until a minimum of 1/32" of conductor extends beyond the terminal barrel.
3. Squeeze tool handles firmly (See Note 2 below).
4. Provide second crimp in the insulation crimp area to close the insulation (See Note 3 below).

Non-Insulated Terminals and Disconnects

1. Locate terminal in proper crimp die with indenter centered on brazed barrel seam (for short locking forks, locate indenter opposite butted barrel seam). Ensure that crimp is perpendicular to the plane of the terminal tongue, as shown (See Note 1 below).
2. Insert properly stripped wire into terminal until a minimum of 1/32" of conductor extends beyond the terminal barrel.
3. Squeeze tool handles firmly (See Note 2 below).

Disconnects

Splices

Ferrules

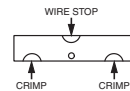
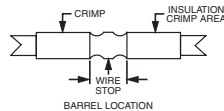

Insulated Butt Splices

1. Locate butt splice in proper size crimp die and position crimp pocket halfway between the wire stop (center of splice) and the wire stop end of the insulation crimp area, as shown (See Note 4 below).
2. Insert properly stripped wire into one end of butt splice.
3. Squeeze tool handles firmly (See Note 2 below).
4. Provide second crimp in the insulation crimp area to close the insulation (See Note 3 below).
5. Repeat steps 1–4 for opposite end of butt splice.

Non-Insulated Butt Splices

1. Locate butt splice in proper size crimp die and position crimp pocket halfway between the wire stop and the butt splice end, as shown.
2. Insert properly stripped wire into one end of the butt splice.
3. Squeeze tool handles firmly. (See Note 2 below).
4. Repeat 1–3 for opposite end of butt splice.

Compression Connectors

Crimping Tools

Mechanical Connectors

Grounding Connectors

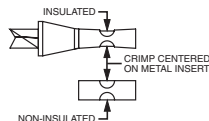

Insulated and Non-Insulated Wire Joints

1. Properly strip wires, twist stripped wire ends together, and insert wires into wire joint.
2. Locate wire joint in proper crimp die and position crimp pocket in the center of the metal insert.
3. Squeeze tool handles firmly (See Note 2 below).

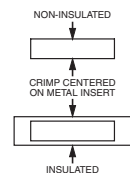

Insulated and Non-Insulated Parallel Splices

1. Locate parallel splice in proper crimp die and position crimp pocket on the center of the metal insert.
2. Insert properly stripped wires into opposite ends of the splice so that the stripped portions of the wire overlap inside the metal insert.
3. Squeeze tool handles firmly (See Note 2 below).

Support Products

Technical Info

NOTES for Crimping with Hand Operated Controlled Cycle Crimping Tools:

1. PANDUIT® controlled cycle crimping tools properly locate rings, forks, barrel insulated and non-insulated disconnects, pins, and blades. No further positioning is required.
2. Once a crimp has been started, the ratchet device of controlled cycle tools will not release until the crimp is complete, independent of operator expertise.
3. Controlled cycle tools provide the electrical crimp and the insulation closure in a single cycle of the tool.
4. When using controlled cycle tooling, insulated butt splices must be inserted from the back of the tool to ensure that the electrical and insulation closure crimp pockets are properly aligned with the splice.

Index

Crimping Guidelines for PANDUIT® PAN-LUG™ Compression Lugs and Splices

1. Select the proper PANDUIT® compression connector for the conductor type and size being used.

- PANDUIT® compression connectors are identified with the proper conductor size and conductor type marked on the tongue or barrel of the connector



- PANDUIT® compression connector packaging comes complete with installation instructions that include the proper conductor size and type to be used with each connector

PANDUIT PART NUMBER	STUD WIRE SIZE	WIRE RANGE-TANGING WIRE (AWG) TOOLS (AWG) (MIN) (MAX)	WIRE STRIP LENGTH (IN.)	CF-1700
LCB4, LCC4, SCL4	6 AWG	—	3/4 1-1/16	RED P21 (3)
LCB6, LCC6, SCL6	6 AWG	—	1-1/4 1-1/8	BLUE P24 (3)
LCB4, LCC4, LCC4-12***, SCL4	2 AWG SOL 4-1/2 AWG STD	4 AWG	1-1/8 1-1/8	GRAY P29 (3)
LCC2, LCC2 SCL2	2 AWG	6-2 AWG	1-1/4 1-1/4	BROWN P33 (3)
LCB1, LCC1, SCL1	1 AWG	6-1 AWG	1-7/16 1-3/8	GREEN P37 (3)
LCC10, LCC10 SCL10	1-10 AWG	6-10 AWG	1-1/2 1-3/8	—
LCC20, LCC20 SCL20	2-10 AWG	4-20 AWG	1-5/8 1-1/2	—
LCC30, LCC30 SCL30	3-10 AWG	2-30 AWG	1-5/16 1-1/2	—

- This catalog includes tool charts that incorporate the proper conductor size and type to be used with each connector*

3. Select the proper crimp die and crimping tool to be used with the connector.

Use crimping tools and dies that provide a UL Listed and/or CSA Certified electrical termination, to assure a safe and reliable connection.

Many PANDUIT® compression connectors are UL Listed and CSA Certified when crimped with PANDUIT® and specified competitor crimping tools and dies. These tools and dies are listed in the tool charts in this catalog*. PANDUIT® crimping tools and dies to be used with each connector are also listed on the instruction sheets included with PANDUIT® product packaging.



PANDUIT® compression connectors are color coded and marked with PANDUIT® and specified competitor die index numbers. Select the proper crimp die to be used by matching the color code and die index number marked on the connector to the same markings on the crimp die.

2. Strip the conductor to the proper strip length. As specified:

- On the PANDUIT® product packaging label or
- On the installation instruction sheet included with PANDUIT® product packaging or
- In the tool charts in this catalog*



Make sure the conductor is not stripped too long, which would result in exposed wire between the barrel of the connector and the cable insulation.

Make sure the conductor is not stripped too short, which would result in a less than complete contact area with the connector when the conductor is inserted in the barrel.

Do not nick or cut strands of conductor during crimping, which would result in a less than premium conductor termination.



Make sure conductor strands are free from corrosion.

4. Crimp the connector.

Insert the conductor into the barrel of the connector. The conductor should stop against the end of the barrel of the lug, or wire stop in the butt splice, upon complete insertion of the conductor in the barrel. Some lugs are offered with inspection windows that provide visual inspection of the complete conductor insertion.



Review the installation instructions included with the PANDUIT® product packaging or the tool charts* for the proper number of crimps to be placed in the

WIRE (AWG) (3)	STD (2)	P (AWG) (3)
CD-200-2/0	STD (2)	CD-2001-2/0 BLACK P45 (3)
CD-200-3/0	STD (2)	CD-2001-3/0 ORANGE P50 (3)
CD-200-4/0	STD (2)	CD-2001-4/0 PURPLE P54 (3)
CD-200-250	STD (3)	CD-2001-250 YELLOW P62 (3)
CD-200-300	STD (3)	CD-2001-300 WHITE P66 (3)
CD-200-350	STD (3)	CD-2001-350 RED P71 (3)
CD-200-400	STD (3)	CD-2001-400

connector. Make the first crimp in the barrel nearest the tongue of the lug, or wire stop in a butt splice, and make successive crimps in the barrel working



towards the conductor entry at the end of the barrel. Use the color coded or knurled band markings on the barrel of the connector to evenly space the placement of the crimps in the barrel.



When properly crimped, the die index number engraved in the crimp die will be embossed into the barrel of the connector. The crimp should be placed in the connector so the die index number can be easily read when the connector is installed.

* See Tool charts on pages L6 - L41

System Overview

Crimping Guidelines for PANDUIT® PAN-LUG™ Copper HTAP and Clear Cover System



Terminals

HTAP Installation

1. Locate desired position of HTAP along main wire run. Allow clearance for tap wires and cover installation. (See clear cover table on [page F109](#).)
2. Strip insulation from wires to the length shown in the HTAP table on [page F108](#). Use care to avoid damaging the conductors.
3. Position wires in the appropriate tap grooves.
4. For easier installation, apply one of the flame retardant cable ties (provided) around the wires and through the slots in the HTAP. **The head of the cable tie must be positioned along the side of the HTAP as shown in Figure A.** Tension and cut off excess length of tie. Additional cable ties may be used adjacent to the HTAP to secure the wires.
5. Install the correct dies ([see page L35](#)) into the crimping tool. **NOTE: The color code and die index number shown on the HTAP and crimp dies must match.**

Figure A

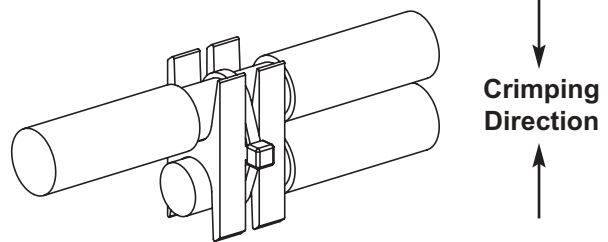

Disconnects

Splices

Ferrules

6. Position the HTAP in the crimp tool so that the entire HTAP will be compressed by the crimping surfaces of the dies in the proper direction. Crimp the connector.
7. After crimping, if desired, cut off the cable tie head or remove the entire cable tie. **NOTE: In some cases, the cable tie head must be cut off in order for the crimped connector to fit inside the insulating cover.**

Compression Connectors

Cover Installation

1. If labels are being utilized, cut labels to the dimensions shown below. **NOTE: When using a PANDUIT® LS7 printer, the length dimensions can be easily programmed to provide cutoff marks.**
2. Position the label(s) in the pockets inside the cover and snap in the label retainer(s) as shown in Figure B. Information can be marked on the matte finish label retainers in lieu of using a separate label.
3. Position one cover half around the crimped connector assembly. Align the second cover half with the first and snap together.
4. Install the two flame retardant cable ties (provided) in the grooved areas on the cover. Tension and cut off excess lengths of ties.

Figure B

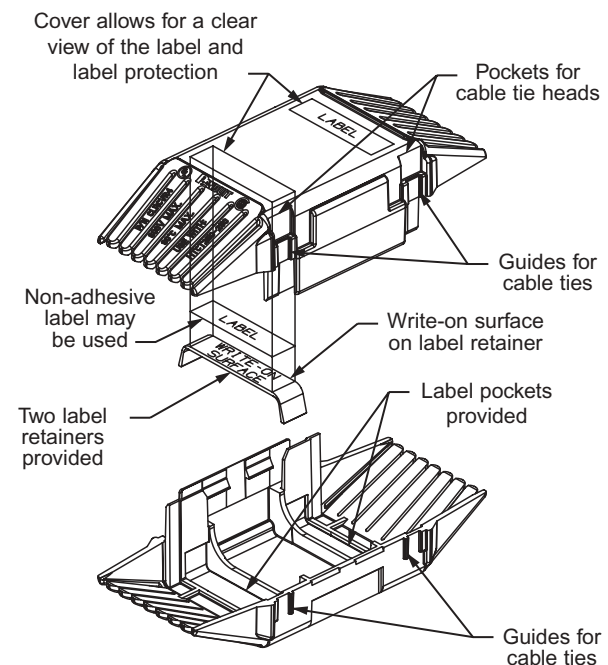

NOTE: Configuration of cover may differ slightly from illustration.

Label Size Information

Clear Cover Part Number	Label Height (Max.)	Label Length (Wrap Around Style)	Label Length (Flat Style)
CLRCVR1-1	.38	1.12	.69
CLRCVR2-1	.38	1.56	1.00
CLRCVR3-1	.38	1.87	1.25
CLRCVR5-1	.38	3.37	2.06
CLRCVR6-1	.38	4.31	2.94

Crimping Tools

Mechanical Connectors

Grounding Connectors

Support Products

Technical Info

Index

Selection Guide — Compression Connector Tools

Tool Selection Guide for Crimping PANDUIT® Copper Compression Lugs and Splices for use with Copper Code Conductor																															
Conductor Type	Connector Type	Tool Type	Copper Conductor Range																												
			#14 AWG	#12 AWG	#10 AWG	#8 AWG	#6 AWG	#4 AWG	#3 AWG	#2 AWG	#1 AWG	1/0 AWG	2/0 AWG	3/0 AWG	4/0 AWG	250 kcmil	300 kcmil	350 kcmil	400 kcmil	500 kcmil	600 kcmil	750 kcmil	800 kcmil	1000 kcmil							
Copper Code Conductor	LCAS LCA LCAN LCB LCB-W LCBH LCD LCDN LCC LCC-W LCCN LCCH SCSS SCS SCL SCH SCT PS RSC	Manual Crimping Tools	CT-100 (Pg. G8)																												
			CT-200 (Pg. G8)																												
			CT-1570 (Pg. G9)																												
			CT-1701 (Pg. G9)																												
							CT-1700* (Pg. G9)																								
				CT-720 (Pg. G11)																											
				CT-930 (Pg. G13)																											
		Manual Hydraulic Crimping Tools				CT-980 UNI-DIE™ (Pg. G27)																									
						CT-2001 (Pg. G14)																									
						CT-2002 (Pg. G15)																									
		Battery Powered Hydraulic Crimping Tools				CT-2931 (Pg. G17)																									
						CT-2930 (Pg. G18)																									
						CT-2940 (Pg. G19)																									
						CT-2981 UNI-DIE™ (Pg. G28)																									
						CT-2980 UNI-DIE™ (Pg. G29)																									
		Remote Crimp Heads				CT-930CH (Pg. G20)																									
						CT-930LPCH (Pg. G23)																									
						CT-940CH (Pg. G21)																									
						CT-980CH UNI-DIE™ (Pg. G30)																									
						CT-980LPCH UNI-DIE™ (Pg. G30)																									

See Tool Charts on [pages L6 - L41](#) for selection of crimp dies and number of crimps used with specific tool and connector combinations.

*CT-1700 is not used for PS splices.

Selection Guide continues on page G6

System Overview

Terminals

Disconnects

Splices

Ferrules

Compression Connectors

Crimping Tools

Mechanical Connectors

Grounding Connectors

Support Products

Technical Info

Index

System Overview

Selection Guide — Compression Connector Tools (continued)

Tool Selection Guide for Crimping PANDUIT® Copper Compression Lugs and Splices for use with Copper Flex Conductor																																																				
Conductor Type	Connector Type	Tool Type	Copper Conductor Range																																																	
			#8 AWG	#6 AWG	#4 AWG	#3 AWG	#2 AWG	#1 AWG	1/0 AWG	2/0 AWG	3/0 AWG	4/0 AWG	250 kcmil	262 kcmil	300 kcmil	313 kcmil	350 kcmil	373 kcmil	400 kcmil	450 kcmil	500 kcmil	535 kcmil	600 kcmil	646 kcmil	750 kcmil	777 kcmil																										
Copper Code and Flex Conductor	LCAX LCAXN LCBX LCDX LCDXN LCCX Maximum Code Conductor Size 4/0 AWG	Manual Crimping Tool	CT-1700 (Pg. G9)																																																	
		Manual Hydraulic Crimping Tool	CT-930 (Pg. G13)																																																	
		Battery Powered Hydraulic Crimping Tools	CT-2001 (Pg. G14)																																																	
			CT-2002 (Pg. G15)																																																	
		CT-2931 (Pg. G17)																																																		
		CT-2930 (Pg. G18)																																																		
		CT-2940 (Pg. G19)																																																		
		CT-930CH (Pg. G20)																																																		
		CT-940CH (Pg. G21)																																																		
		Copper Flex Conductor	LCAF LCCF SCSF RSC	Manual Hydraulic Crimping Tool	CT-930 (Pg. G13)																																															
Battery Powered Hydraulic Crimping Tools	CT-2931 (Pg. G17)																																																			
	CT-2930 (Pg. G18)																																																			
	CT-2940 (Pg. G19)																																																			
CT-930CH (Pg. G20)																																																				
CT-940CH (Pg. G21)																																																				

See Tool Charts on [pages L6 - L41](#) for selection of crimp dies and number of crimps used with specific tool and connector combinations.

Technical Info

Index

Selection Guide — Compression Connector Tools (continued)

Tool Selection Guide for Crimping PANDUIT® Aluminum Compression Lugs and Splices for use with Copper or Aluminum Code Conductor																													
Conductor Type	Connector Type	Tool Type	Copper or Aluminum Conductor Range																										
			#6 AWG	#4 AWG	#3 AWG	#2 AWG	#1 AWG	1/0 AWG	2/0 AWG	3/0 AWG	4/0 AWG	250 kcmil	300 kcmil	350 kcmil	400 kcmil	500 kcmil	600 kcmil	750 kcmil	800 kcmil	1000 kcmil									
Copper or Aluminum Code Conductor	LAA LAB SA	Manual Crimping Tools	CT-1700 (Pg. G9)																										
			CT-720 (Pg. G11)																										
		Manual Hydraulic Crimping Tool	CT-930 (Pg. G13)																										
		Battery Powered Hydraulic Crimping Tools	CT-2931 (Pg. G17)																										
			CT-2930 (Pg. G18)																										
			CT-2940 (Pg. G19)																										
		Remote Crimp Heads	CT-930CH (Pg. G20)																										
			CT-940CH (Pg. G21)																										

See Tool Charts on [pages L6 - L41](#) for selection of crimp dies and number of crimps used with specific tool and connector combinations.

System Overview

Terminals

Disconnects

Splices

Ferrules

Compression Connectors

Crimping Tools

Mechanical Connectors

Grounding Connectors

Support Products

Technical Info

Index

System Overview

Manual Hand Tools

- Plier type
- Installer controlled crimp

Terminals



CT-260

Disconnects



CT-200

Splices



CT-160

Ferrules



CT-100

Part Number	Part Description	Std. Pkg. Qty.
CT-260	Forged steel tool. Crimps insulated and non-insulated terminals. Cuts wire. (See crimp tool section of product charts.)	1
CT-200	Forged steel tool. Crimps most PANDUIT® #18 – #10 AWG non-insulated terminals, disconnects and splices. Cuts wire. (See crimp tool section of product charts.)	1
CT-160	Crimps most PANDUIT® #26 – #10 AWG insulated and non-insulated terminals disconnects and splices. Cuts three U.S. and three Metric screw sizes. Cuts and strips wire. Has insulation closure pocket. (See crimp tool section of product charts.)	1
CT-100	Crimps most PANDUIT® #26 – #10 AWG insulated and non-insulated terminals, disconnects and splices. Cuts #4, #6, #8 and #10 screw sizes. Cuts and strips wire. Excellent all-around application tool of heat treated finished steel with comfortable cushioned plastic grip handles. (See crimp tool section of product charts.)	1

Reference crimping guidelines for *PAN-TERM*® Terminals, Disconnects and Splices, see [page G2](#).
NOTE: Refer to Tool Selection Chart for specific crimp tool selection.

Compression Connectors

CONTOUR CRIMP™ Controlled Cycle Tools

- Specifically designed for the installation of *PAN-TERM*® terminals, disconnects and splices
- Superior crimp performance
- Low handle effort — increases productivity
- Reliable — backed by a two year warranty

Crimping Tools

Mechanical Connectors



Superior Locator

Superior Balance

Controlled Cycle Mechanism

Cushioned Non-Slip Grip Material

Grounding Connectors

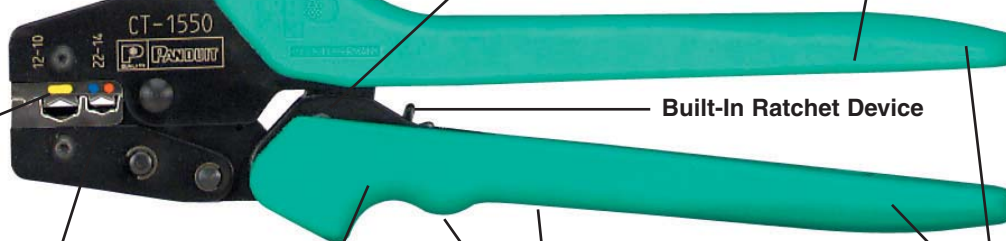

Built-In Ratchet Device

Support Products

Die Identifiers

Revolutionary Die Placement

Narrow Grip Span

Contoured Handles

“Two-Handed” Handle Design

Technical Info

The Bottom Line:

These ergonomically engineered crimping tools promote operator comfort and safety which lead to greater productivity. This provides the lowest installed cost.

Index

CONTOUR CRIMP™ Controlled Cycle Tools



CT-1525



CT-1550



CT-1551



CT-1570



CT-1700



CT-1701



CT-1014



CT-1015

- Specifically designed for the installation of *PAN-TERM*® terminals, disconnects and splices
- Superior crimp performance
- Low handle effort — increases productivity
- Reliable — backed by a two year warranty

Part Number	Part Description	Std. Pkg. Qty.
CT-1525	Crimps <i>PANDUIT</i> ® #26 – #22 AWG insulated terminals and splices, #22 – #10 AWG fully insulated disconnects and insulated parallel splices. Crimps <i>PANDUIT</i> ® #22 – #14 AWG barrel insulated disconnects.	1
CT-1550	Crimps most <i>PAN-TERM</i> ® #22 – #10 AWG nylon and vinyl insulated terminals, splices and disconnects. The CT-1550 has the red/blue pocket closest to the pivot which provides a reduced crimp effort for those who make red/blue terminations.	1
CT-1551	Crimps most <i>PAN-TERM</i> ® #22 – #10 AWG nylon and vinyl insulated terminals, splices and disconnects. The CT-1551 has the yellow pocket closest to the pivot which provides a reduced crimp effort for those who make yellow terminations.	1
CT-1570	Crimps most <i>PAN-TERM</i> ® #22 – #10 AWG and .5-6.0 mm non-insulated terminals and disconnects. Crimps <i>PANDUIT</i> #22 – #10 AWG and .5-6.0 mm non-insulated splices, and #10 AWG compression lugs.	1
CT-1700	Crimps <i>PANDUIT</i> ® #8 – #2 AWG non-insulated tubular terminals (S series), #8 – #1 AWG copper lugs and splices, #6 – #4 AWG aluminum lugs and splices and CTAPF copper taps for #14 – #3 AWG. Includes 5 position, color coded rotating die.	1
CT-1701	Crimps <i>PANDUIT</i> ® #10 – #2 AWG non-insulated large gauge ring terminal (P series). Crimps #8 – #1 AWG copper lugs and splices, and #6 – #4 AWG aluminum lugs and splices and #14 – #3 AWG CTAPF copper taps. Includes 5 position rotating die.	1
CT-1014	Crimps <i>PANDUIT</i> ® #22 – #14 AWG loose piece <i>Disco-Lok</i> ™ disconnects.	1
CT-1015	Crimps <i>PANDUIT</i> ® #22 – #14 AWG loose piece <i>SUPRA-GRIP</i> ™ disconnects.	1

- Speciality crimping tools for fully insulated right angle disconnects and heat shrink insulated terminals, disconnects and splices.



CT-300-1

Part Number	Part Description	Std. Pkg. Qty.
CT-300-1	Crimps <i>PANDUIT</i> ® #22 – #14 AWG fully insulated right angle disconnects. (DNFR-FIB series)	1
CT-310	Crimps <i>PANDUIT</i> ® #22 – #10 AWG heat shrink insulated terminals, disconnects and splices.	1

System Overview

Terminals

Disconnects

Splices

Ferrules

Compression Connectors

Crimping Tools

Mechanical Connectors

Grounding Connectors

Support Products

Technical Info

Index

System Overview

Controlled Cycle Crimping Tools – Ferrule End Sleeve

Terminals



CT-1003 Crimp Tool Application

Disconnects



CT-1002

Splices



CT-1003

Ferrules



CT-1004

Compression Connectors



CT-1005

Crimping Tools



CT-1006

Part Number	Part Description	Std. Pkg. Qty.
CT-1002	Crimps <i>PANDUIT</i> ® #26 – #10 AWG single vinyl insulated ferrules (DIN). #26 – #10 AWG single wire insulated ferrules (French). #22 – #12 AWG vinyl insulated dual-wire ferrules (DIN). #24 – #10 AWG non-insulated ferrules.	1
CT-1003	Crimps <i>PANDUIT</i> ® #22 – #8 AWG single wire insulated ferrules (DIN). #22 – #8 AWG single wire vinyl insulated ferrules (French). #22 – #10 AWG vinyl insulated dual-wire (DIN) ferrules. #22 – #10 AWG non-insulated ferrules.	1
CT-1004	Crimps <i>PANDUIT</i> ® #8 – #6 AWG single wire vinyl insulated ferrule (DIN). #8 – #6 AWG single wire vinyl insulated ferrules (French). #10 AWG vinyl insulated dual-wire (DIN) ferrule. #8 – #6 AWG non-insulated ferrules.	1
CT-1005	Crimps <i>PANDUIT</i> ® #4 – #2 AWG single wire vinyl insulated ferrule (DIN). #4 – #2 AWG single wire vinyl insulated ferrules (French). #4 – #2 AWG non-insulated ferrules.	1
CT-1006	Crimps <i>PANDUIT</i> ® #1 AWG single wire vinyl insulated ferrule (DIN) and (French). #1 AWG non-insulated ferrules.	1

Mechanical Connectors

Controlled Cycle Crimping Tools – In-Line

Grounding Connectors



CT-400 and CT-460

- Military specialty tools help meet military and nuclear test requirements
- In-line crimp action for greater dielectric strength with uniform insulation compression
- Calibration-recalibration is possible for maintaining exact crimp dimensions
- High performance to help meet military and nuclear requirements

Support Products

Technical Info

Part Number	Part Description	Std. Pkg. Qty.
CT-400	Crimps #22 – #14 <i>PANDUIT</i> ® insulated terminals, disconnects and splices. Comes complete with carrying/storage case which includes tools for calibration. Has adjustable pre-load and emergency ratchet. Helps meet military and nuclear requirements.	1
CT-460	Crimps #16 – #10 <i>PANDUIT</i> ® insulated terminals, disconnects and splices. Has same features as CT-400 above.	1

Index

Pneumatic Crimping Tool

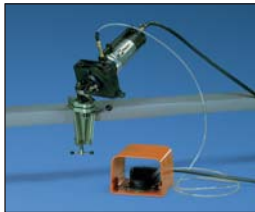

CT-600

- Quickly crimps a variety of loose piece terminals in a variety of wire sizes for medium volume production
- Versatile-interchangeable crimping heads let you switch terminal types quickly to meet changing production requirements. This tool, when used with only four crimp heads, can crimp a full range of #26 thru #10 AWG insulated and non-insulated terminal products
- Portable — the small size, ease of bench mounting and quick pneumatic connection allow the tool to be moved from one work station to another or to the work itself

Part Number	Part Description	Std. Pkg. Qty.
CT-600	Pneumatic tool, 6 ft. air hose and carrying case. Does not include crimping heads (ordered separately).	1
CT-500CH	Crimping head for most #22 – 14 insulated terminals, splices and disconnects.	1
CT-520CH	Crimping head for most #22 – 14 insulated butted seam disconnects and #26 – 22 insulated terminals.	1
CT-550CH	Crimping head for most #22 – 10 insulated terminals and splices.	1
CT-570CH	Crimping head for #22 – 10 non-insulated terminals, splices and disconnects.	1
PD-600	Positioning device (for bench mounting of CT-600)	1
FPC-600	Foot actuator operating air pressure: 80-100 psi .233 SCFM type of air: lubricated. Recommend using Norgren (Brand) #FLR222-012-043008 filter lubricator regulator.	1

For proper crimp head selection, see [pages L2, L3, L4](#) in Technical Info section of this catalog.

Compression Connector Tools

Die Type, Manual, Crimping Tool



CT-720

- High quality, durable tool construction provides long term dependability
- Develops 6 tons of crimping force, crimps copper compression lugs and splices up to 500 kcmil
- Provides UL Listed and CSA Certified connections on PANDUIT® copper and aluminum lugs and splices and insulated terminals
- Cushioned grips prevent hands from slipping on tool and reduce fatigue
- Uses single retention screw for fast and easy die change-over
- Uses color coded crimp dies to provide easy matching of crimp die to connector
- Embosses die index number on connector barrels to provide post crimp inspection
- Available with or without control cycle feature to meet specific applications

Part Number	Part Description	Std. Pkg. Qty.
CT-720	Manual crimping tool for UL Listed or Recognized and CSA Certified terminations of PANDUIT® PAN-LUG™ copper compression lugs and splices for #8 AWG – 500 kcmil copper code conductor and aluminum compression lugs and splices for #6 AWG – 350 kcmil copper and aluminum code conductors. Provides UL Listed terminations of PANDUIT® PAN-TERM® #8 – #2 AWG vinyl insulated terminals. Color coded CD-720 crimp dies, carrying/storage case and controlled cycle mechanism must be purchased separately. Specifications: Output: 6 tons Weight: 7.7 lbs. Length: 26" Handle span: 58" (open), 2.5" (closed) Warranty: 90 days	1
CC-720	Optional control cycle mechanism only. Total weight of tool with CC-720 is 8.25 lbs.	1
C-720	Steel carrying case for CT-720 crimping tool.	1

System Overview

CD-720 Crimping Dies

Terminals



CD-720PV8-2

Disconnects

Splices

Ferrules

Compression Connectors

Crimping Tools

Mechanical Connectors

Grounding Connectors

Support Products

Technical Info

Index

- Color coded for easy matching to color coding marked on connectors
- Embosses die index number on connector barrels to provide post crimp inspection except CD-720PV8-2
- Part number permanently marked on crimp die for easy identification
- Provides 5-sided crimp results in terminations with premium electrical and mechanical performance

Part Number	Used to Install PANDUIT® Compression Lug & Splice Sizes				Std. Pkg. Qty.
	Copper Conductor Size	Copper Die Color & No.	Aluminum Conductor Size	Aluminum Die Color & No.	
CD-720-1	#8 – #2 AWG	Red P21, Blue P24, Gray P29, Brown P33	#6 AWG	Gray P29	1
CD-720-2	#1 – 3/0 AWG	Green P37, Pink P42, Black P45, Orange P50	#4 – 1/0 AWG	Green P37, Pink P42, Gold P45, Tan P50	1
CD-720-3	4/0 AWG – 250 kcmil	Purple P54, Yellow P62	2/0 – 3/0 AWG	Olive P54, Ruby P62	1
CD-720-4	300 kcmil	White P66	4/0 AWG	White P66	1
CD-720-5	350 kcmil	Red P71	250 kcmil	Red P71	1
CD-720-6	400 kcmil	Blue P76	300 kcmil	Blue P76	1
CD-720-7	500 kcmil	Brown P87	350 kcmil	Brown P87	1
CD-720PV8-2	#8 – #2 AWG, vinyl insulated PAN-TERM® terminals	Red, Blue, Yellow	—	—	1

See [pages L6 – L41](#) in Technical Info section for connector and tool selection information.

Die Type, Manual, Crimping Tool and Die Kits



Includes tool, crimp dies and carrying case

- Available with or without controlled cycle feature to meet specific applications
- Kits available with three or full set of seven dies for crimping partial or full range of connector sizes

Part Number	Part Description	Std. Pkg. Qty.
CT-720-7	Basic tool kit with seven dies. Includes: • Seven dies (CD-720-1 – 7) for installing #8 AWG – 500 kcmil copper compression connectors • Carrying/storage case (C-720)	1
CT-720-7CC	Controlled cycle tool kit with seven dies. Controlled cycle mechanism factory installed on crimping tool. Includes: • Seven dies (CD-720-1 – 7) for installing #8 AWG – 500 kcmil copper compression connectors • Carrying/storage case (C-720)	1
CT-720-3	Basic tool kit with three dies. Includes: • Three dies (CD-720-1 – 3) for installing #8 AWG – 250 kcmil copper compression connectors • Carrying/storage case (C-720)	1
CT-720-3CC	Controlled cycle tool kit with three dies. Controlled cycle mechanism factory installed on crimping tool. Includes: • Three dies (CD-720-1 – 3) for installing #8 AWG – 250 kcmil copper compression connectors • Carrying/storage case (C-720)	1

Die Type, Manual Hydraulic, 14 Ton, Crimping Tool



- Develops 14 tons of crimping force, crimps copper compression lugs and splices up to 750 kcmil
- Two-stage rapid advance hydraulic system minimizes number of pumps required to complete a crimp – saves time
- High quality, durable tool construction provides long-term dependability
- Cushioned grip prevents hands from slipping on tool – reduces fatigue
- Provides UL Listed and CSA Certified connections on PANDUIT® PAN-LUG™ copper and aluminum lugs and splices and copper taps
- Open “C-Head” design allows easy loading of crimp dies and connectors, saves time
- Uses color coded crimp dies to provide easy matching of crimp die to connector
- Embosses die index number on connector barrels to provide post crimp inspection
- Dies installed using spring loaded die retention pins, no need for tools
- Rubber boot on crimp head provides abrasion protection
- Audible “pop-off” valve indicates crimp completion
- Crimp head rotates 180 degrees, provides versatility for use in restricted spaces

Part Number	Part Description	Std. Pkg. Qty.
CT-930	<p>Terminates PANDUIT® PAN-LUG™ Compression Connectors:</p> <ul style="list-style-type: none"> • Copper compression lugs and splices for #8 AWG – 750 kcmil code conductor • Copper compression lugs and splices for #8 AWG – 600 kcmil flex conductor • Copper compression CTAPF taps for #10 AWG – 3/0 AWG code conductor • Copper compression CTAP taps for #8 AWG – 4/0 AWG code conductor • Copper compression HTCT taps for #14 AWG – 250 kcmil code conductor, #14 AWG – 4/0 AWG flex conductor • Aluminum compression lugs and splices for #6 AWG – 600 kcmil code conductor • Aluminum compression HTAPS for #14 AWG – 500 kcmil code conductor • PANDUIT® PAN-TERM® Tubular Terminals for #8 AWG – 250 kcmil code conductor <p>Specifications: Output: 14 tons Jaw Opening: 1.65" Weight: 16.5 lbs. Length: 25" Handle Span: 17 1/2" (open), 6" (closed) Warranty: 5 years</p> <p>CT-930 includes:</p> <ul style="list-style-type: none"> • Tool • Plastic tool case with die storage 	1

Uses CD-920 and CD-930 color coded crimp dies. Dies must be purchased separately, see [page G25](#). CG-920 crimp force measurement gauge available, sold separately see [page G31](#).

System Overview

Terminals

Disconnects

Splices

Ferrules

Compression Connectors

Crimping Tools

Mechanical Connectors

Grounding Connectors

Support Products

Technical Info

Index

System Overview

Die Type, Battery Powered Hydraulic, 6 Ton, Crimping Tool with Closed Head

Terminals



Disconnects

Splices

Ferrules

Compression Connectors

Crimping Tools

Mechanical Connectors

Grounding Connectors

Support Products

Technical Info

Index

- Battery powered — provides fingertip operation
- Self-contained unit — completely portable
- Lightweight and ergonomically balanced for easy operation without fatigue
- Develops 6 tons of crimping force, crimps copper compression lugs and splices up to 500 kcmil
- Provides UL Listed and CSA Certified connections on *PANDUIT® PAN-LUG™* copper lugs, splices and taps
- Audible “pop-off” valve indicates crimp completion
- Tool provided with two, NiCd rechargeable batteries and battery charger to allow for continuous operation
- High productivity — up to 80 crimps on 500 kcmil copper lugs and splices on a single battery charge
- Six to eight second crimp cycle time, provides quick terminations, saves time
- Battery charger charges expended batteries completely in 25 minutes
- Battery charger includes battery reconditioner feature which prevents battery memory build-up and provides over 1,000 battery recharge cycles resulting in long life
- Uses color coded crimp dies to provide easy matching of crimp die to connector
- Embosses die index number on connector barrels to provide post crimp inspection
- Dies installed using spring loaded die retention pins — no need for tools
- Crimp head rotates 180 degrees — provides versatility for use in restricted spaces

Part Number	Part Description	Std. Pkg. Qty.
CT-2001	<p>Terminates <i>PANDUIT® PAN-LUG™</i> Compression Connectors:</p> <ul style="list-style-type: none"> • Copper compression lugs and splices for #8 AWG – 500 kcmil code conductor • Copper compression lugs for #8 AWG – 350 kcmil flex conductor • Copper compression CTAPF taps for #10 AWG – 3/0 AWG code conductor • Copper compression CTAP taps for #8 AWG – #2 AWG code conductor • Aluminum compression lugs and splices for #6 AWG – 300 kcmil code conductor (not UL or CSA) • Aluminum compression HTAPS for #14 AWG – 4/0 AWG code conductor (not UL or CSA) • <i>PANDUIT® PAN-TERM®</i> Tubular Terminals for #8 AWG – 250 kcmil code conductor <p>Specifications: Output: 6 tons Jaw opening: 1.8" Weight: 8.5 lbs. with battery Length: 13" Height: 12" Width: 3" Warranty: 3 years on tool, 5 years on batteries</p> <p>CT-2001 includes:</p> <ul style="list-style-type: none"> • Tool • Two CT-NLBC25, 14.4 VDC rechargeable batteries (non-LED) • One CT-CHR25 battery charger • One shoulder strap • Plastic tool case with storage for batteries, charger, shoulder strap and crimp dies • Tool incorporates D3 die pocket (included with tool) 	1

Uses color-coded CD-2001 crimp dies. Dies must be purchased separately, see [page G16](#).
 For battery charger and battery accessories, see [page G32](#).

Die Type, Battery Powered Hydraulic, 6 Ton, Crimping Tool with Open "C-Head"



- Battery powered — provides fingertip operation
- Self-contained unit — completely portable
- Lightweight and ergonomically balanced for easy operation without fatigue
- Develops 6 tons of crimping force, crimps copper compression lugs and splices up to 500 kcmil
- Provides UL Listed and CSA Certified connections on *PANDUIT® PAN-LUG™* copper lugs, splices and taps
- Open "C-Head" design allows easy loading of crimp dies and connectors, saves time
- Rubber boot on crimp head provides abrasion protection
- Audible "pop-off" valve indicates crimp completion
- Tool provided with two, NiCd rechargeable batteries and battery charger to allow for continuous operation
- High productivity — up to 80 crimps on 500 kcmil copper lugs and splices on a single battery charge
- Six to eight second crimp cycle time, provides quick terminations, saves time
- Battery charger charges expended batteries completely in 25 minutes
- Batteries include LED battery charge indicators for visual indication of current battery charge
- Battery charger includes battery reconditioner feature which prevents battery memory build-up and provides over 1,000 battery recharge cycles resulting in long life
- Uses color coded crimp dies to provide easy matching of crimp die to connector
- Embosses die index number on connector barrels to provide post crimp inspection
- Dies installed using spring loaded die retention pins — no need for tools
- Crimp head rotates 180 degrees — provides versatility for use in restricted spaces

Part Number	Part Description	Std. Pkg. Qty.
CT-2002	<p>Terminates <i>PANDUIT® PAN-LUG™</i> Compression Connectors:</p> <ul style="list-style-type: none"> • Copper compression lugs and splices for #8 AWG – 500 kcmil code conductor • Copper compression lugs for #8 AWG – 350 kcmil flex conductor • Copper compression CTAPF taps for #10 AWG – 3/0 AWG code conductor • Copper compression CTAP taps for #8 AWG – #2 AWG code conductor • Aluminum compression lugs and splices for #6 AWG – 300 kcmil code conductor (not UL or CSA) • Aluminum compression HTAPS for #14 AWG – 4/0 AWG code conductor (not UL or CSA) • <i>PANDUIT® PAN-TERM®</i> Tubular Terminals for #8 AWG – 250 kcmil code conductor <p>Specifications: Output: 6 tons Jaw opening: .95" Weight: 9.0 lbs. with battery Length: 13" Height: 12" Width: 3" Warranty: 5 years tool, 1 year on batteries</p> <p>CT-2002 includes:</p> <ul style="list-style-type: none"> • Tool • Two CT-BC25, 14.4 VDC rechargeable batteries with LED display • One CT-CHR25 battery charger • One shoulder strap • Plastic tool case with storage for batteries, shoulder strap and crimp dies • Tool incorporates D3 die pocket (included with tool) 	1

Uses color-coded CD-2001 crimp dies. Dies must be purchased separately, see [page G16](#).
 For battery charger and battery accessories, see [page G32](#).

System Overview

Terminals

Disconnects

Splices

Ferrules

Compression Connectors

Crimping Tools

Mechanical Connectors

Grounding Connectors

Support Products

Technical Info

Index

System Overview

CD-2001 and CDM-2001 Crimping Dies



CD-2001

- Color coded to provide easy matching to color coding marked on connectors
- Part number permanently marked on crimp die for easy identification
- Embosses die index number on connector barrels to provide post crimp inspection
- Provides circumferential crimp results in terminations with premium electrical and mechanical performance

Terminals

Disconnects

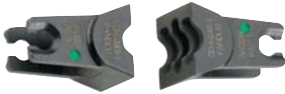

CDM-2001

Splices

Ferrules

Compression Connectors

Crimping Tools

Mechanical Connectors

Grounding Connectors

Support Products

Technical Info

Part Number	Used to Install PANDUIT® Compression Lug & Splice Sizes				Std. Pkg. Qty.
	Copper Conductor Size Code	Copper Die Color & No.	Aluminum Conductor Size	Aluminum Die Color & No.	
CD-2001-8	# 8 AWG	Red P21	—	—	1
CD-2001-6	#6 AWG	Blue P24	—	—	1
CD-2001-4	#4 AWG STR #3 AWG STR #2 AWG SOL	Gray P29	#6 AWG	Gray P29	1
CD-2001-2	#2 AWG	Brown P33	—	—	1
CD-2001-1	#1 AWG	Green P37	#4 AWG	Green P37	1
CD-2001-1/0	1/0 AWG	Pink P42	#2 AWG	Pink P42	1
CD-2001-2/0	2/0 AWG	Black P45	#1 AWG	Gold P45	1
CD-2001-3/0	3/0 AWG	Orange P50	1/0 AWG	Tan P50	1
CD-2001-4/0	4/0 AWG	Purple P54	2/0 AWG	Olive P54	1
CD-2001-250	250 kcmil	Yellow P62	3/0 AWG	Ruby P62	1
CD-2001-300	300 kcmil	White P66	4/0 AWG	White P66	1
CD-2001-350	350 kcmil	Red P71	250 kcmil	Red P71	1
CD-2001-400	400 kcmil	Blue P76	300 kcmil	Blue P76	1
CD-2001-500	500 kcmil	Brown P87	—	—	1

Part Number	Used to Install PANDUIT® Tap Part Numbers			Std. Pkg. Qty.
	Copper Tap	Die Color & No.	Aluminum Tap	
Single Crimp Dies				
CD-2001-8	CTAPF10-16-C	Red P21	—	1
CD-2001-6	CTAPF8-12-C	Blue P24	—	1
CD-2001-4	CTAPF6-12-C	Gray P29	—	1
CD-2001-2	CTAPF4-12-C	Brown P33	—	1
CD-2001-1	CTAPF3-12-C	Green P37	—	1
CD-2001-1/0	CTAPF2-12-C	Pink P42	—	1
CD-2001-2/0	CTAPF1-12-C	Black P45	—	1
CD-2001-3/0	CTAPF1/0-12-L	Orange P50	HTAP2-8-L	1
CD-2001-4/0	CTAPF2/0-12-Q	Purple P54	—	1
CD-2001-250	CTAPF3/0-12-Q	Yellow P62	—	1
CD-2001-BG	CTAP4-4-L to CTAP4-8-L	PBG	—	1
CD-2001-C	CTAP2-4-Q to CTAP2-2-X	PC	—	1
CD-2001-O	—	Green PO	HTAP1-1-Q to HTAP2/0-1-Q	1

Multi-Crimp Dies				
CDM-2001-2	CTAPF4-12-C	Brown P33M	—	1
CDM-2001-1	CTAPF3-12-C	Green P37M	—	1
CDM-2001-1/0	CTAPF2-12-C	Pink P42M	—	1
CDM-2001-2/0	CTAPF1-12-C	Black P45M	—	1
CDM-2001-3/0	CTAPF1/0-12-L	Orange P50M	—	1

See [pages L6 – L41](#) in Technical Info section for connector and tool selection information.

Index

Die Type, Battery Powered Hydraulic, 12 Ton, Crimping Tool



- Battery powered — provides fingertip operation
- Self-contained unit — completely portable
- Develops 12 tons of crimping force, crimps copper compression lugs and splices up to 750 kcmil
- Two stage rapid advance hydraulic system minimizes cycle time
- Provides UL Listed and CSA Certified connections on *PANDUIT® PAN-LUG™* copper and aluminum lugs and splices and copper taps
- Open “C-Head” design allows easy loading of crimp dies and connectors, saves time
- Rubber boot on crimp head provides abrasion protection
- Ram automatically retracts when crimp cycle is complete
- Tool provided with two, high capacity 12 VDC rechargeable nickel-metal hydride batteries — provides for continuous operation and eliminates “memory” build-up, one hour charge time
- Eight second crimp cycle time provides quick terminations, saves time
- Uses industry standard Makita* batteries and charger — industry proven reliability easy to obtain from local retail sources
- Uses color coded crimp dies to provide easy matching of crimp die to connector
- Embosses die index number on connector barrels to provide post crimp inspection
- Dies installed using spring loaded die retention pins — no need for tools
- Crimp head rotates 360 degrees — provides versatility for use in restricted spaces

Part Number	Part Description	Std. Pkg. Qty.
CT-2931	<p>Terminates <i>PANDUIT® PAN-LUG™</i> Compression Connectors:</p> <ul style="list-style-type: none"> • Copper compression lugs and splices for #8 AWG – 750 kcmil code conductor • Copper compression lugs and splices for #8 AWG – 600 kcmil flex conductor • Copper compression CTAPF taps for #10 AWG – 3/0 AWG code conductor • Copper compression CTAP taps for #8 AWG – 4/0 AWG code conductor • Copper compression HTCT taps for #14 AWG – 250 kcmil code conductor, #14 AWG – 4/0 AWG flex conductor • Aluminum compression lugs and splices for #6 AWG – 600 kcmil code conductor • Aluminum compression HTAPS for #14 AWG – 500 kcmil code conductor • <i>PANDUIT® PAN-TERM®</i> Tubular Terminals for #8 AWG – 250 kcmil code conductor <p>Specifications: Output: 12 tons Jaw opening: 1.65" Weight: 15.2 lbs with battery Length: 15 5/8" Height: 12" Width: 3 3/16" Warranty: 3 years</p> <p>CT-2931 includes: • Tool • Two 12 VDC, rechargeable NiMH batteries • One battery charger • Steel tool case with storage for batteries, charger and crimp dies</p>	1
CT-ACADPT	A.C. Adapter provides continuous operation of crimping tool using 120 VAC 60Hz available outlet. Incorporates 16.5' power cord which provides mobility of tool operation.	1

Uses CD-920 and CD-930 color-coded crimp dies. Dies must be purchased separately, see [page G25](#). CG-920 crimp force measurement gauge available, sold separately, see [page G31](#).

*Makita is a registered trademark of Makita Corporation in the United States.

System Overview

Terminals

Disconnects

Splices

Ferrules

Compression Connectors

Crimping Tools

Mechanical Connectors

Grounding Connectors

Support Products

Technical Info

Index

System Overview

Die Type, Battery Powered Hydraulic, 14 Ton, Crimping Tool

Terminals



Disconnects

Splices

Ferrules

Compression Connectors

Crimping Tools

Mechanical Connectors

Grounding Connectors

Support Products

Technical Info

Index

- Battery powered — provides fingertip operation
- Self-contained unit — completely portable
- Develops 14 tons of crimping force, crimps copper compression lugs and splices up to 750 kcmil
- Provides UL Listed and CSA Certified connections on PANDUIT® PAN-LUG™ copper and aluminum lugs and splices and copper taps
- Open “C-Head” design allows easy loading of crimp dies and connectors, saves time
- Rubber boot on crimp head provides abrasion protection
- Audible “pop-off” valve indicates crimp completion
- Tool provided with two, NiCd rechargeable batteries and battery charger allows for continuous operation
- High productivity — up to 50 crimps on 500 kcmil copper lugs and splices on a single battery charge
- Eight second crimp cycle time provides quick terminations, saves time
- Battery charger charges expended batteries completely in 25 minutes
- Batteries include LED battery charge indicators for visual indication of current battery charge
- Battery charger includes battery reconditioner feature which prevents battery memory build-up and provides over 1,000 battery recharge cycles resulting in long life
- Uses color coded crimp dies to provide easy matching of crimp die to connector
- Embosses die index number on connector barrels to provide post crimp inspection
- Dies installed using spring loaded die retention pins, no need for tools
- Crimp head rotates 180 degrees, provides versatility for use in restricted spaces

Part Number	Part Description	Std. Pkg. Qty.
CT-2930	<p>Terminates PANDUIT® PAN-LUG™ Compression Connectors:</p> <ul style="list-style-type: none"> • Copper compression lugs and splices for #8 AWG – 750 kcmil code conductor • Copper compression lugs and splices for #8 AWG – 600 kcmil flex conductor • Copper compression CTAPF taps for #10 AWG – 3/0 AWG code conductor • Copper compression CTAP taps for #8 AWG – 4/0 AWG code conductor • Copper compression HTCT taps for #14 AWG – 250 kcmil code conductor, #14 AWG – 4/0 AWG flex conductor • Aluminum compression lugs and splices for #6 AWG – 600 kcmil code conductor • Aluminum compression HTAPS for #14 AWG – 500 kcmil code conductor • PANDUIT® PAN-TERM® Tubular Terminals for #8 AWG – 250 kcmil code conductor <p>Specifications: Output: 14 Tons Jaw opening: 1.65" Weight: 17.5 lbs with battery Length: 16" Height: 12" Width: 3" Warranty: 5 years tool, 1 year on batteries</p> <p>CT-2930 includes:</p> <ul style="list-style-type: none"> • Tool • Two CT-BC25, 14.4 VDC rechargeable batteries with LED display • One CT-CHR25 battery charger • One shoulder strap • Plastic tool case with storage for batteries, charger, shoulder strap and crimp dies 	1

Uses CD-920 and CD-930 color-coded crimp dies. Dies must be purchased separately, see [page G25](#). CG-920 crimp force measurement gauge available, sold separately, see [page G31](#). For battery charger and battery accessories, see [page G32](#).

Die Type, Battery Powered Hydraulic, 15 Ton, Crimping Tool



- Battery powered — provides fingertip operation
- Self-contained unit — completely portable
- Develops 15 tons of crimping force, crimps copper compression lugs and splices up to 1,000 kcmil
- Provides UL Listed and CSA Certified connections on PANDUIT® PAN-LUG™ copper and aluminum lugs and splices and copper taps
- Flip-top crimp head design allows easy loading of crimp dies and connectors, saves time
- Rubber boot on crimp head provides abrasion protection
- Audible “pop-off” valve indicates crimp completion
- Tool provided with two, NiCd rechargeable batteries and battery charger, allows for continuous operation
- High productivity — up to 35 crimps on 500 kcmil copper lugs and splices on a single battery charge
- Eight second crimp cycle time provides quick terminations, saves time
- Battery charger charges expended batteries completely in 25 minutes
- Batteries include LED battery charge indicators for visual indication of current battery charge
- Battery charger includes battery reconditioner feature which prevents battery memory build-up and provides over 1,000 battery recharge cycles resulting in long life
- Uses color coded crimp dies to provide easy matching of crimp die to connector
- Embosses die index number on connector barrels to provide post crimp inspection
- Dies installed using spring loaded die retention pins — no need for tools
- Crimp head rotates 180 degrees — provides versatility for use in restricted spaces

Part Number	Part Description	Std. Pkg. Qty.
CT-2940	<p>Terminates PANDUIT® PAN-LUG™ Compression Connectors:</p> <ul style="list-style-type: none"> • Copper compression lugs and splices for #8 AWG – 1000 kcmil code conductor • Copper compression lugs and splices for #8 AWG – 777.7 kcmil flex conductor • Copper compression CTAPF taps for #10 AWG – 3/0 AWG code conductor • Copper compression CTAP taps for #8 AWG – 4/0 AWG code conductor • Copper compression HTCT taps for #14 AWG – 1000 kcmil code conductor and #14 AWG – 777.7 kcmil flex conductor • Aluminum compression lugs and splices for #6 AWG – 1000 kcmil code conductor • Aluminum compression HTAP taps for #14 AWG – 500 kcmil code conductor • PANDUIT® PAN-TERM® Tubular Terminals for #8 AWG – 250 kcmil code conductor <p>Specifications: Output: 15 tons Jaw opening: 2" Weight: 24.25 lbs. with battery Length: 21" Height: 10.5" Width: 3.75" Warranty: 5 years tool, 1 year on batteries</p> <p>CT-2940 includes:</p> <ul style="list-style-type: none"> • Tool • Two CT-BC25, 14.4 VDC rechargeable batteries with LED display • One CT-CHR25 battery charger • Shoulder strap • Plastic case for storage of crimp dies • Plastic tool case with storage for batteries, charger, shoulder strap and crimp die storage case 	1

Uses CD-920 and CD-930 color-coded crimp dies with CD-940-DA die adapter.
 Uses CD-940 color-coded crimp dies.
 Dies and die adapter must be purchased separately, see [pages G25 and G26](#).
 For battery charger and battery accessories, see [page G32](#).

System Overview

Terminals

Disconnects

Splices

Ferrules

Compression Connectors

Crimping Tools

Mechanical Connectors

Grounding Connectors

Support Products

Technical Info

Index

System Overview

Die Type, Remote Hydraulic, 14 Ton, Crimp Head



Terminals

Disconnects

Splices

Ferrules

Compression Connectors

Crimping Tools

Mechanical Connectors

Grounding Connectors

Support Products

Technical Info

Index

- Develops 14 tons of crimping force when used with 10,000 psi hydraulic pump and hose, crimps copper compression lugs and splices up to 750 kcmil
- Incorporates Parker type quick-connect fittings — eases installation and saves time
- High quality, durable tool construction provides long-term dependability
- Provides UL Listed and CSA Certified connections on *PANDUIT® PAN-LUG™* copper and aluminum lugs and splices and copper taps
- Open “C-Head” design allows easy loading of crimp dies and connectors, saves time
- Uses color coded crimp dies to provide easy matching of crimp die to connector
- Embosses die index number on connector barrels for post crimp inspection
- Dies installed using spring loaded die retention pins — no need for tools
- Cast in handle allows crimp head to be mounted in a bench vice

Part Number	Part Description	Std. Pkg. Qty.
CT-930CH	<p>Terminates <i>PANDUIT® PAN-LUG™</i> Compression Connectors:</p> <ul style="list-style-type: none"> • Copper compression lugs and splices for #8 AWG – 750 kcmil code conductor • Copper compression lugs and splices for #8 AWG – 600 kcmil flex conductor • Copper compression CTAPF taps for #10 AWG – 3/0 AWG code conductor • Copper compression CTAP taps for #8 AWG – 4/0 AWG code conductor • Copper compression HTCT taps for #14 AWG – 250 kcmil code conductor, #14 AWG – 4/0 AWG flex conductor • Aluminum compression lugs and splices for #6 AWG – 600 kcmil code conductor • Aluminum compression HTAPS for #14 AWG – 500 kcmil code conductor • <i>PANDUIT® PAN-TERM®</i> Tubular Terminals for #8 AWG – 250 kcmil code conductor <p>Use with hydraulic systems developing 10,000 PSI of hydraulic pressure.*</p> <p>Specifications: Output: 14 tons Jaw opening: 1.65" Weight: 11 lbs. Length: 12 1/4" Height: 5" Width: 3" Warranty: 5 years</p> <p>CT-930CH includes: • Tool • Steel tool case • Supplied with female Parker type quick-connect fitting assembled to tool</p>	1

Uses CD-920 and CD-930 color-coded crimp dies. Dies must be purchased separately, see [page G25](#).

*CT-901 RCH remote control handle available, offering one hand operation of crimp head with *PANDUIT®* CT-901HP hydraulic pump and CT-900HPH hose, sold separately, see [page G22](#). CG-920 crimp force measurement gauge available, sold separately, see [page G31](#).

Die Type, Remote Hydraulic, 15 Ton, Crimp Head



- Develops 15 tons of crimping force when used with 10,000 psi hydraulic pump and hose, crimps copper compression lugs and splices up to 1,000 kcmil
- Incorporates Parker type quick-connect fittings — eases installation and saves time
- High quality, durable tool construction provides long-term dependability
- Provides UL Listed and CSA Certified connections on *PANDUIT® PAN-LUG™* copper and aluminum lugs and splices and copper taps
- Open “C-Head” design allows easy loading of crimp dies and connectors, saves time
- Uses color coded crimp dies to provide easy matching of crimp die to connector
- Embosses die index number on connector barrels for post crimp inspection
- Dies installed using spring loaded die retention pins, no need for tools
- Cast in handle allows crimp head to be mounted in a bench vice

Part Number	Part Description	Std. Pkg. Qty.
CT-940CH	<p>Terminates <i>PANDUIT® PAN-LUG™</i> Compression Connectors:</p> <ul style="list-style-type: none"> • Copper compression lugs and splices for #8 AWG – 1000 kcmil code conductor • Copper compression lugs and splices for #8 AWG – 777.7 kcmil flex conductor • Copper compression CTAPF taps for #10 AWG – 3/0 AWG code conductor • Copper compression CTAP taps for #8 AWG – 4/0 AWG code conductor • Copper compression HTCT taps for #14 AWG – 1000 kcmil code conductor and #14 AWG – 777.7 kcmil flex conductor • Aluminum compression lugs and splices for #6 AWG – 1000 kcmil code conductor • Aluminum compression HTAP taps for #14 AWG – 500 kcmil code conductor • <i>PANDUIT® PAN-TERM®</i> Tubular Terminals for #8 AWG – 250 kcmil code conductor <p>Use with hydraulic systems developing 10,000 PSI of hydraulic pressure.*</p> <p>Specifications: Output: 15 tons Jaw opening: 2" Weight: 14.5 lbs. Length: 14.5" Height: 4.1" Width: 2.5" Warranty: 5 years</p> <p>CT-940CH includes: • Tool • Steel tool case • Supplied with female Parker type quick-connect fitting assembled to tool</p>	1

Uses CD-920 and CD-930 color-coded crimp dies with CD-940-DA die adapter. Uses color-coded CD-940 crimp dies. Crimp dies and die adapter must be purchased separately, see [pages G25 and G26](#).

CG-940 crimp force measurement gauge available, sold separately, see [page G31](#).

*CT-901RCH remote control handle available, offering one hand operation of crimp head with *PANDUIT®* CT-901HP hydraulic pump and CT-900HPH hose, sold separately, see [page G22](#).

System Overview

Terminals

Disconnects

Splices

Ferrules

Compression Connectors

Crimping Tools

Mechanical Connectors

Grounding Connectors

Support Products

Technical Info

Index

System Overview

Hydraulic Pump and Accessories, Electric, 10,000 PSI

Terminals



CT-901HP

- Develops 10,000 psi of hydraulic pressure
- Easy to operate using manual switch or remote pendant supplied; or optional CT-901RFS foot switch or CT-901RCH remote controlled handle
- Factory set relief valve — pump stops when crimp is complete
- Convenient 120 VAC operation
- Incorporates Parker type quick-connect fittings — eases installation and saves time
- Versatile — can be used with *PANDUIT*® CT-930CH, CT-940CH or CT-980CH crimp heads

Disconnects



CT-900HPH

Splices



CT-901RCH

Ferrules

Compression Connectors



CT-901RFS

Crimping Tools

Mechanical Connectors

Grounding Connectors

Support Products

Technical Info

Index

Part Number	Part Description	Std. Pkg. Qty.
CT-901HP	Hydraulic pump. Develops 10,000 PSI output. Pump shuts off when cycle is complete. Will not release until down switch is activated. Compatible with CT-900HPH hydraulic hose, CT-930CH, CH-940CH and CT-980CH crimp heads sold separately.* Specifications: Pump output: 10,000 psi Tank capacity: 2.5L incorporates sight gage for visual inspection of fluid level. Fluid type: Aero Shell #4 or equal Motor: 120 VAC 50/50Hz Current: 6.5 amps Horsepower: 1/2 hp Weight: 34 lbs. Length: 7" Height: 14" Width: 6" Warranty: 5 years CT-901HP pump includes: • On/off pendant switch on 10' electric cord • 3 prong A/C plug on 10' electric cord • Supplied with female Parker type quick-connect fitting assembled to pump	1
CT-900HPH	Electrically non-conductive 10' hose compatible with <i>PANDUIT</i> ® CT-901HP hydraulic pump and CT-930CH, CT-940CH and CT-980CH crimp heads, supplied pre-filled with hydraulic fluid for fast start up. Supplied with two male Parker type quick-connect fittings. Warranty: 5 years	1
CT-901RCH	Remote control handle provides plastic carrying handle incorporating on/off activation switch that allows operator to hold crimp head and activate CT-901HP hydraulic pump with one hand. Use with <i>PANDUIT</i> ® remote hydraulic crimp heads CT-930CH, CT-940CH and CT-980CH. Equipped with 3/8" Parker type quick-connect coupler for attaching crimp heads to <i>PANDUIT</i> ® CT-900HPH hydraulic hose. Includes a 10', three wire control cable that can be directly connected to the CT-901HP pump. Warranty: 5 years	1
CT-901RFS	Dual electrical foot switch that allows convenient "hands free" operation of the <i>PANDUIT</i> ® CT-901HP or CT-8250HP electric hydraulic pumps used with <i>PANDUIT</i> ® remote hydraulic crimp heads. Supplied with 10' electric cord that can be directly connected to <i>PANDUIT</i> ® hydraulic pumps. Warranty: 5 years	1

Contact *PANDUIT*® Technical Assistance for use in production environments.

*For information on crimp heads, see [pages G20, G21 and G30](#).

Die Type, Remote Hydraulic, 10.5 Ton, Crimp Head



- Low pressure system extends life of crimp head for high volume crimping applications
- Develops 10.5 tons of crimping force when used with 7,500 psi hydraulic pump and hose, crimps copper compression lugs and splices up to 250 kcmil
- Incorporates Parker type quick-connect fittings — eases installation and saves time
- High quality, durable tool construction and low pressure hydraulic requirements provide long-term dependability and tool life
- Provides UL Listed and CSA Certified connections on PANDUIT® PAN-LUG™ copper lugs and splices
- Open “C-Head” design allows easy loading of crimp dies and connectors, saves time
- Uses color-coded crimp dies to provide easy matching of crimp die to connector
- Embosses die index number on connector barrels for post crimp inspection
- Dies installed using spring loaded die retention pins — no need for tools
- Cast in handle allows crimp head to be mounted in a bench vice

Part Number	Part Description	Std. Pkg. Qty.
CT-930LPCH	<p>Remote hydraulic crimp head provides UL Listed or Recognized terminations of PANDUIT® PAN-LUG™ copper compression lugs and splices for #8 AWG – 250 kcmil copper code conductor.</p> <p>Use with PANDUIT® CT-8250HP hydraulic pump and CT-900LPHPH 10' hydraulic hose.*</p> <p>Specifications: Output: 10.5 tons Jaw opening: 1.65" Weight: 11 lbs. Length: 12 1/4" Height: 5" Width: 3" Warranty: 5 years</p> <p>CT-930LPCH includes: • Tool • Steel tool case • Supplied with male Parker type quick-connect fitting assembled to tool</p>	1

Uses CD-920 color-coded crimp dies. Dies must be purchased separately, see [page G25](#).
 PG-1 in-line pressure gauge provides visual measurement of hydraulic output pressure, sold separately, see [page G31](#).

*For information on hydraulic pump and hose, see [page G24](#).

System Overview

Terminals

Disconnects

Splices

Ferrules

Compression Connectors

Crimping Tools

Mechanical Connectors

Grounding Connectors

Support Products

Technical Info

Index

System Overview

Hydraulic Pump and Accessories, Electric, 7,500 PSI

Terminals



CT-8250HP

Disconnects



CT-900LPHPH

Splices



CT-901RFS

Ferrules

Compression Connectors

Crimping Tools

Mechanical Connectors

Grounding Connectors

Support Products

Technical Info

Index

- Develops 7,500 psi of hydraulic pressure
- Easy to operate using manual switch or remote pendant supplied; or optional CT-901RFS foot switch
- Factory set relief valve — pump stops when crimp is complete
- Convenient 120 VAC operation
- Incorporates Parker type quick-connect fittings — eases installation and saves time
- Versatile — can be used with **PANDUIT®** CT-930LPCH or CT-980LPCH crimp heads

Part Number	Part Description	Std. Pkg. Qty.
CT-8250HP	<p>Hydraulic pump. Develops 7,500 psi output. Pump shuts off when cycle is complete. Will not release until down switch is activated. Compatible with CT-900LPHPH hydraulic hose, CT-930LPCH, and CT-980LPCH crimp heads sold separately.*</p> <p>Specifications: Pump output: 7,500 psi Tank Capacity: 2.5L incorporates sight gauge for visual inspection of fluid level Fluid type: Aero Shell #4 or equal Motor: 120 VAC 50/50Hz Current: 6.5 amps Horsepower: 1/2 hp Warranty: 5 years</p> <p>Weight: 34 lbs. Length: 7" Height: 14" Width: 6"</p> <p>CT-8250HP pump includes: • On/off pendant switch on 10' electric cord • Three prong A/C plug on 10' electric cord • Supplied with male Parker type quick-connect fitting assembled to pump</p>	1
CT-900LPHPH	Electrically non-conductive 10' hose compatible with PANDUIT® CT-901LPHPH hydraulic pump and CT-930LPCH, and CT-980LPCH crimp heads, supplied pre-filled with hydraulic fluid for fast start up. Supplied with two female Parker type quick-connect fittings. Warranty: 5 years	1
CT-901RFS	Dual electrical foot switch that allows convenient "hands free" operation of the PANDUIT® CT-901HP or CT-8250HP electric hydraulic pumps used with PANDUIT® remote hydraulic crimp heads. Supplied with 10' electric cord that can be directly connected to PANDUIT® hydraulic pumps. Warranty: 5 years	1

*For more information on crimp heads, see [pages G23 and G30](#).

PG-1 in-line pressure gauge provides visual measurement of hydraulic output pressure, sold separately, see [page G31](#).

CD-920 and CDM-920 Crimping Dies



CD-920

- Color coded for easy matching to color coding marked on connectors
- Embosses die index number on connector barrels for post crimp inspection
- Part number permanently marked on crimp die for easy identification
- Provides circumferential crimp results in terminations with premium electrical and mechanical performance

Part Number	Used to Install PANDUIT® Compression Lug & Splice Sizes				Std. Pkg. Qty.
	Copper Code Conductor Size	Copper Die Color & No.	Aluminum Code Conductor Size	Aluminum Die Color & No.	
CD-920-8	#8 AWG	Red P21	—	—	1
CD-920-6	#6 AWG	Blue P24	—	—	1
CD-920-4	#4 AWG	Gray P29	#6 AWG	Gray P29	1
CD-920-2	#2 AWG	Brown P33	—	—	1
CD-920-1	#1 AWG	Green P37	#4 AWG	Green P37	1
CD-920-1/0	1/0 AWG	Pink P42	#2 AWG	Pink P42	1
CD-920-2/0	2/0 AWG	Black P45	#1 AWG	Gold P45	1
CD-920-3/0	3/0 AWG	Orange P50	1/0 AWG	Tan P50	1
CD-920-4/0	4/0 AWG	Purple P54	2/0 AWG	Olive P54	1
CD-920-250	250 kcmil	Yellow P62	3/0 AWG	Ruby P62	1
CD-920-300	300 kcmil	White P66	4/0 AWG	White P66	1
CD-920-350	350 kcmil	Red P71	250 kcmil	Red P71	1
CD-920-400	400 kcmil	Blue P76	300 kcmil	Blue P76	1
CD-920-500	500 kcmil	Brown P87	350 kcmil	Brown P87	1
CD-920-600	600 kcmil	Green P94	400 kcmil	Green P94	1
CD-920-500A	500 kcmil flex, 600 kcmil flex	Pink P99	500 kcmil	Pink P99	1
CD-920-750	750 kcmil	Black P106	600 kcmil	Black P106	1

Part Number	Used to Install PANDUIT® Tap Part Numbers				Std. Pkg. Qty.
	Copper Tap	Copper Die Color & No.	Aluminum Tap	Aluminum Die Color & No.	

Single Crimp Dies

CD-920H-8	HTCT8-8-1	Green PH8	—	—	1
CD-920H-6	HTCT6-6-1	Orange PH6	—	—	1
CD-920H-2	HTCT2-2-1	Brown PH2	—	—	1
CD-930H-250	HTCT250-8-1, HTCT250-2-1, HTCT250-250-1	Purple PH25	—	—	1
CD-920-3/0	—	—	HTAP2-8-L	Tan P50	1
CD-920-BG	CTAP4-8-L, CTAP4-6-L, CTAP4-4-L	PBG	—	—	1
CD-920-C	CTAP2-4-Q, CTAP2-2-X	PC	—	—	1
CD-920-D3	CTAP4/0-2-X, CTAP4/0-2/0-X, CTAP4/0-4/0-X	PD3	HTAP3/0-1-Q, HTAP3/0-3/0-Q, HTAP4/0-2-Q, HTAP4/0-3/0-Q, HTAP4/0-4/0-Q	PD3	1
CD-920-O	CTAP2/0-2-X, CTAP2/0-2/0-X	PO	HTAP1-1-Q, HTAP1/0-1-Q, HTAP2/0-1-Q	PO	1
CD-930-N	—	—	HTAP500-500-X, HTAP500-4/0-X	PN	1

Multi-Crimp Dies

CDM-920-2	CTAPF4-12-C	Brown P33M	—	—	1
CDM-920-1	CTAPF3-12-C	Green P37M	—	—	1
CDM-920-1/0	CTAPF2-12-C	Pink P42M	—	—	1
CDM-920-2/0	CTAPF1-12-C	Black P45M	—	—	1
CDM-920-3/0	CTAPF1/0-12-L	Orange P50M	—	—	1
CDM-920-4/0	CTAPF2/0-12-Q	Purple P54M	—	—	1
CDM-920-250	CTAPF3/0-12-Q	Yellow P62M	—	—	1

See [pages L6 – L41](#) in Technical Info section for connector and tool selection information.



CDM-920

System Overview

Terminals

Disconnects

Splices

Ferrules

Compression Connectors

Crimping Tools

Mechanical Connectors

Grounding Connectors

Support Products

Technical Info

Index

System Overview

CD-940 Crimping Dies

Terminals



CD-940

- Color coded for easy matching to color coding marked on connectors
- Embosses die index number on connector barrels for post crimp inspection
- Part number permanently marked on crimp die for easy identification
- Provides circumferential crimp results in terminations with premium electrical and mechanical performance

Disconnects

Splices

Ferrules

Compression Connectors

Crimping Tools



CD-940-DA

Mechanical Connectors

Grounding Connectors

Support Products

Technical Info

Index

Part Number	Used to Install <i>PANDUIT</i> ® Compression Lug & Splice Sizes				Std. Pkg. Qty.
	Copper Conductor Size	Copper Die Color & No.	Aluminum Conductor Size	Aluminum Die Color & No.	
CD-940-750	750 kcmil	Black P106	—	—	1
CD-940-800	800 kcmil	Orange P107	—	—	1
CD-940-1000	1000 kcmil	White P125	—	—	1
CD-940-750X	777.7 kcmil flex	Yellow P115	—	—	1
CD-940-750A	—	—	750 kcmil	Red P125	1
CD-940-800A	—	—	800 kcmil	Gray P140	1
CD-940-1000A	—	—	1000 kcmil	Brown P161	1

Part Number	Used to Install <i>PANDUIT</i> ® Tap Part Numbers				Std. Pkg. Qty.
	Copper Tap	Copper Die Color & No.	Aluminum Tap	Aluminum Die Color & No.	
CD-940-N	—	—	HTAP500-500-X, HTAP500-4/0-X	PN	1
CD-940H-500	HTCT500-250-1, HTCT500-500-1	Brown PH50	—	—	1
CD-940H-750	HTCT750-4/0-1, HTCT750-750-1, HTCT1000-250-1	Yellow PH75	—	—	1
CD-940H-1000	HTCT1000-1000-1	White PH10	—	—	1

See [pages L6 – L41](#) in Technical Info section for connector and tool selection information.

Part Number	Part Description	Std. Pkg. Qty.
CD-940-DA	Die Adapter for use with <i>PANDUIT</i> ® CD-920, CDM-920 and CD-930 crimp dies	1

UNI-DIE™ Dieless, Manual Hydraulic, 6.2 Ton, Crimping Tool



- Dieless crimping tool design eliminates purchase or lost crimp dies, saves cost
- Develops 6.2 tons of crimping force with four point indenter system, crimps copper compression lugs and splices up to 750 kcmil
- Two stage rapid advance hydraulic system minimizes number of pumps required to complete a crimp
- High quality, durable tool construction provides long-term dependability
- Cushioned grips prevent hands from slipping on tool, reduces fatigue
- Incorporates aluminum crimp head and fiberglass handles, results in lightweight tool and ease of operation
- Provides UL Listed and CSA Certified connections on PANDUIT® PAN-LUG™ copper lugs and splices
- Provides UL Listed and CSA Certified wire range-taking capability on PANDUIT® PAN-LUG™ copper lugs and splices, minimizes connector inventory and saves cost
- Flip-top crimp head design allows easy loading of crimp dies and connectors, saves time
- Audible “pop-off” valve indicates crimp completion
- Crimp head rotates 360 degrees, provides versatility for use in restricted spaces

Part Number	Part Description	Std. Pkg. Qty.
CT-980	<p>Manual hydraulic UNI-DIE™ dieless crimping tool provides UL Listed or Recognized and CSA Certified terminations of PANDUIT® PAN-LUG™ copper compression lugs and splices for #4 AWG – 750 kcmil copper code conductor. Terminates PAN-LUG™ aluminum compression lugs and splices for #6 AWG – 500 kcmil copper and aluminum code conductor (not UL or CSA).</p> <p>Specifications: Output: 6.2 tons Jaw opening: 1.46" Weight: 10.5 lbs. Length: 13" Height: 12" Width: 3" Handle span: 15" (open), 5.75" (closed) Warranty: 5 years</p> <p>CT-980 includes: • Tool • Plastic tool case</p>	1

CG-980 pressure gauge for measuring tool output force available, sold separately, see [page G31](#).

System Overview

Terminals

Disconnects

Splices

Ferrules

Compression Connectors

Crimping Tools

Mechanical Connectors

Grounding Connectors

Support Products

Technical Info

Index

System Overview

UNI-DIE™ Dieless, Battery Powered Hydraulic, 6.2 Ton, Crimping Tool, 12 VDC



Terminals

Disconnects

Splices

Ferrules

Compression Connectors

Crimping Tools

Mechanical Connectors



Grounding Connectors

Support Products

Technical Info

Index

- Dieless crimping tool design eliminates purchase or lost crimp dies, saves cost
- Battery powered — provides fingertip operation
- Self-contained unit — completely portable
- Develops 6.2 tons of crimping force with four point indenter system, crimps copper compression lugs and splices up to 750 kcmil
- Two stage rapid advance hydraulic system minimizes cycle time
- Ram automatically retracts when crimp cycle is complete
- Tool provided with two, high capacity 12 VDC rechargeable nickel-metal hydride batteries — provides for continuous operation and eliminates “memory” build-up, one hour charge time
- Uses industry standard Makita* batteries and charger, industry proven reliability and easy to obtain from local retail sources
- Provides UL Listed and CSA Certified connections on PANDUIT® PAN-LUG™ copper lugs and splices
- Provides UL Listed and CSA Certified wire range-taking capability on PANDUIT® PAN-LUG™ copper lugs and splices, minimizes connector inventory and saves cost
- Flip-top crimp head design allows easy loading of splices, saves time
- Crimp head rotates 360 degrees, provides versatility for use in restricted spaces

Part Number	Part Description	Std. Pkg. Qty.
CT-2981	<p>Battery powered hydraulic UNI-DIE™ dieless crimping tool provides UL Listed or Recognized and CSA Certified terminations of PANDUIT® PAN-LUG™ copper compression lugs and splices for #4 AWG – 750 kcmil copper code conductor. Terminates PAN-LUG™ aluminum compression lugs and splices for #6 AWG – 500 kcmil copper and aluminum code conductor (not UL or CSA).</p> <p>Specifications: Output: 6.2 tons Jaw opening: 1.46" Weight: 10.8 lbs. with battery Length: 13" Height: 12" Width: 3" Warranty: 3 years</p> <p>CT-2981 includes: • Tool • Two 12 VDC, NiMH rechargeable batteries • One battery charger • Steel tool case with storage for batteries, charger and crimp dies</p>	1
SS-1	Test solder slugs	1
SS-1GAGE	Solder slug measurement gauge	1
CT-ACADPT	A.C. Adapter provides continuous operation of crimping tool using 120 VAC 60Hz available outlet. Incorporates 16.5' power cord which provides mobility of tool operation.	1

CG-980 crimp force measurement gauge available, sold separately, see [page G31](#).

*Makita is a registered trademark of Makita Corporation in the United States.

UNI-DIE™ Dieless, Battery Powered Hydraulic, 6.2 Ton, Crimping Tool, 14.4 VDC



- Dieless crimping tool design eliminates purchase or lost crimp dies, saves cost
- Battery powered — provides fingertip operation
- Self-contained unit — completely portable
- Develops 6.2 tons of crimping force with four point indenter system, crimps copper compression lugs and splices up to 750 kcmil
- Tool provided with two, NiCd rechargeable batteries and battery charger, provides continuous operation
- High productivity — up to 50 crimps on 500 kcmil copper lugs and splices on a single battery charge
- Eight second crimp cycle time provides quick terminations
- Battery charger charges expended batteries completely in 25 minutes, saves time
- Batteries include LED battery charge indicators to provide visual indication of current battery charge
- Battery charger provided with battery reconitioner feature, prevents battery memory build-up and provides over 1,000 battery recharge cycles, resulting in long life
- Provides UL Listed and CSA Certified connections on PANDUIT[®] PAN-LUG™ copper lugs and splices
- Provides UL Listed and CSA Certified wire range-taking capability on PANDUIT[®] PAN-LUG™ copper lugs and splices, minimizes connector inventory and saves cost
- Flip-top crimp head design allows easy loading of crimp dies and connectors, saves time
- Crimp head rotates 360 degrees — provides versatility for use in restricted spaces

Part Number	Part Description	Std. Pkg. Qty.
CT-2980	<p>Battery powered hydraulic UNI-DIE™ dieless crimping tool provides UL Listed or Recognized and CSA Certified terminations of PANDUIT[®] PAN-LUG™ copper compression lugs and splices for #4 AWG – 750 kcmil copper code conductor. Terminates PAN-LUG™ aluminum compression lugs and splices for #6 AWG – 500 kcmil copper and aluminum code conductor (not UL or CSA).</p> <p>Specifications: Output: 6.2 tons Jaw Opening: 1.46" Weight: 11.7 lbs. with battery Length: 15.5" Height: 12" Width: 3" Warranty: 5 years</p> <p>CT-2980 includes: • Tool • Two CT-BC25, 14.4 VDC rechargeable batteries with LED display • One CT-CHR25 battery charger • Shoulder strap • Plastic tool case with storage for batteries, charger, shoulder strap and crimp dies.</p>	1

CG-980 crimp force measurement gauge available, sold separately, see [page G31](#). For battery charger and battery accessories, see [page G32](#).

System Overview

Terminals

Disconnects

Splices

Ferrules

Compression Connectors

Crimping Tools

Mechanical Connectors

Grounding Connectors

Support Products

Technical Info

Index

System Overview

UNI-DIE™ Dieless, Remote Hydraulic, 6.2 Ton, Crimp Head



Terminals

- Dieless crimping tool design eliminates purchase or lost crimp dies, saves cost
- Develops 6.2 tons of crimping force when used with 10,000 psi hydraulic pump and hose, crimps copper compression lugs and splices up to 750 kcmil
- Incorporates Parker type quick-connect fittings — eases installation and saves time
- Provides UL Listed and CSA Certified connections on PANDUIT® PAN-LUG™ copper lugs and splices
- Provides UL Listed and CSA Certified wire range-taking capability on PANDUIT® PAN-LUG™ copper lugs and splices — minimizes connector inventory and saves cost
- Flip-top crimp head design allows easy loading of splices, saves time

Disconnects

Part Number	Part Description	Std. Pkg. Qty.
CT-980CH	Remote hydraulic <i>UNI-DIE™</i> dieless crimp head provides UL Listed or Recognized and CSA Certified terminations of PANDUIT® PAN-LUG™ copper compression lugs and splices for #4 AWG – 750 kcmil copper code conductor. Terminates PAN-LUG™ aluminum compression lugs and splices for #6 AWG – 500 kcmil copper and aluminum code conductor (not UL or CSA). Use with hydraulic systems developing 10,000 PSI of hydraulic pressure.* Specifications: Output: 6.2 tons Jaw opening: 1.46" Weight: 6.5 lbs. Length: 10.5" Height: 5.3" Width: 2.5" Warranty: 5 years CT-980CH includes: • Tool • Steel tool case • Supplied with female Parker type quick-connect fitting assembled to tool	1

Splices

Ferrules

Compression Connectors

*CT-901RCH remote control handle available, offering one hand operation of crimp head with PANDUIT® CT-901HP hydraulic pump and CT-900HPH hose, sold separately, see [page G22](#). CG-980 crimp force measurement gauge available, sold separately, see [page G31](#).

Crimping Tools

UNI-DIE™ Dieless, Remote Hydraulic, 4.7 Ton, Crimp Head



Mechanical Connectors

- Low pressure system extends life of crimp head for high volume crimping application
- Dieless crimping tool design eliminates purchase or lost crimp dies, saves cost
- Develops 4.7 tons of crimping force when used with 7,500 psi hydraulic pump and hose, crimps copper compression lugs and splices up to 250 kcmil
- Incorporates Parker type quick-connect fittings — eases installation and saves time
- Provides UL Listed and CSA Certified connections on PANDUIT® PAN-LUG™ copper lugs and splices
- Flip-top crimp head design allows easy loading of splices, saves time

Grounding Connectors

Part Number	Part Description	Std. Pkg. Qty.
CT-980LPCH	Remote hydraulic crimp head provides UL Listed or Recognized and CSA Certified terminations of PANDUIT® PAN-LUG™ copper compression lugs and splices for #4 AWG – 250 kcmil code conductor. Specifications: Output: 4.7 tons Weight: 6.5 lbs. Length: 10.5" with coupler Height: 5.3" Width: 2.5" Warranty: 5 years CT-980LPCH includes: • Tool • Steel tool case • Supplied with male Parker type quick-connect fitting assembled to tool	1

Support Products

Technical Info

Use with PANDUIT® CT-8250HP hydraulic pump and CT-900LPHPH 10' hydraulic hose, see [page G24](#). PG-1 in-line pressure gauge provides visual measurement of hydraulic output pressure, sold separately, see [page G31](#).

Index

Pressure Gauges



CG-920



CG-940



CG-980



PG-1

- Provides easy visual reading of output force for hydraulic crimping tools
- Factory calibrated to provide accuracy and quality assurance control of crimping tools in the field
- Easy-to-read crimp force tolerance zone for applicable tools marked on gauge
- Blank dies for fixture supplied with test gauge for easy mounting and operation of gauge with crimping tool

Part Number	Part Description	Std. Pkg. Qty.
CG-920	<p>Compression gauge — Used to measure crimping force generated by <i>PANDUIT</i>® crimping tools: CT-930, CT-930CH, CT-930LPCH, CT-2930 and CT-2931.</p> <p>CG-920 includes:</p> <ul style="list-style-type: none"> • Pressure gauge • Blank die set • Steel storage case • Warranty: 90 days 	1
CG-940	<p>Compression gauge — Used to measure output force generated by <i>PANDUIT</i>® crimping tools: CT-940CH and CT-2940.</p> <p>CG-940 includes:</p> <ul style="list-style-type: none"> • Pressure gauge • Blank die set • Steel storage case • Warranty: 90 days 	1
CG-980	<p>Compression gauge — Used to insure proper compression force for <i>UNI-DIE</i>™ dieless tools: CT-980, CT-980CH, CT-2980 and CT-2981.</p> <p>CG-980 includes:</p> <ul style="list-style-type: none"> • Pressure gauge • Fixture for mounting gauge in crimp tool • Steel storage case • Warranty: 90 days 	1
PG-1	<p>In-line pressure gauge provides visual identification of hydraulic output pressure when used with <i>PANDUIT</i>® CT-930LPCH and CT-980LPCH crimp heads, CT-8250HP pump and CT-900LPHPH hose. Includes steel storage case. Warranty: 90 days</p>	1

System Overview

Terminals

Disconnects

Splices

Ferrules

Compression Connectors

Crimping Tools

Mechanical Connectors

Grounding Connectors

Support Products

Technical Info

Index

System Overview

Accessories for Battery Powered Hydraulic Crimping Tools

Terminals



CT-BC25

Disconnects



CT-NLBC25

Splices

Ferrules

Compression Connectors



CT-CHR25

Part Number	Part Description	Std. Pkg. Qty.
CT-BC25	Rechargeable 14.4 volt DC NiCd battery with LED display to monitor remaining power and number of charge cycles. Battery life is approximately 1,000 recharge cycles. Use with <i>PANDUIT</i> ® battery operated crimping tools: CT-2001, CT-2002, CT-2930, CT-2980 and CT-2940. Warranty: 1 year	1
CT-NLBC25	Rechargeable 14.4 volt DC NiCd battery without LED display. Battery life is approximately 1,000 recharge cycles. Use with <i>PANDUIT</i> ® battery operated crimping tools: CT-2001, CT-2002, CT-2930, CT-2980 and CT-2940. Warranty: 5 years	1
CT-CHR25	Battery charger designed to charge the CT-BC25 and CT-NLBC25 batteries in 25 minutes. Includes battery reconditioning feature to maximize battery life. LED display to visually indicate battery charge status. 120 VAC, 50/60Hz UL Listed. Use with <i>PANDUIT</i> ® battery powered crimping tools: CT-2001, CT-2002, CT-2930, CT-2980 and CT-2940. Warranty: 5 years	1
C-2001	High impact strength, blow molded plastic case for CT-2001 crimping tool. Includes storage for CT-CHR25 battery charger, two CT-NLBC25 batteries, shoulder strap and crimp dies.	1

Crimping Tools

Cable Stripping Tools

Mechanical Connectors



CST114-157

Grounding Connectors

Support Products

Technical Info



CST101



CST115

Index

- Provides safe and easy stripping of cable insulation for cables 3/16" to 1 9/16" diameter
- Cutting blade provides circular, spiral and in-line insulation cutting
- Spiral cut mode — tough/hard insulations peel off easily
- In-line cut mode — for use with softer insulation like neoprene
- Unique blade profile— for long life, low friction stripping of difficult insulations like rubber and silicon
- Cutting blade easily adjusts to proper height to cut insulation without nicking conductor strands
- Ergonomic shape — for safe comfortable use
- Compact design
- Easy-fit replacement blade, one spare blade included with tool

Part Number	Wire Range (O.D.)	Part Description	Std. Pkg. Qty.
CST114-157	.18" – 1.57"	Cable stripping tool for stripping insulation from cables 3/16" to 1 9/16" diameter. Includes replacement cutting blade. Warranty: 90 days	1

- Lightweight and durable
- Spring loaded handles
- Rust resistant coating
- Plastic coated handles
- Bright colored for ease of visibility

Part Number	Wire Range (O.D.)	Part Description	Std. Pkg. Qty.
CST101	# 20 – #10 AWG	V notch wire stripper.	1
CST115	# 20 – #10 AWG	Plier nose wire stripper.	1

PAN-LUG™ MECHANICAL CONNECTORS

PANDUIT® offers a broad variety of mechanical lugs, splices and split bolt connectors suitable for a wide range of electrical terminations using code conductor. Designed to be reusable and installed without special tooling, PAN-LUG™ Mechanical Connectors provide quality performance, ease of installation and lowest installed cost.

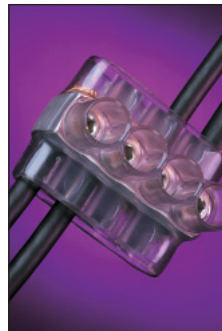

- Functional product information is marked directly on the connector, facilitating the identification, ordering and usage of the mechanical connector
- Incorporate wire range-taking capability to minimize inventory requirements
- Made from high strength, high conductivity electrolytic copper and aluminum alloy materials to provide optimum connectivity for power and grounding applications
- UL Listed and CSA Certified, as noted

PAN-LUG™ Mechanical Connectors include split bolt connectors, copper mechanical lugs, aluminum mechanical lugs and aluminum multi-tap connectors with clear PVC insulation. Products are available in stamped and formed, extruded and cast varieties of multiple barrel and tongue configurations to provide solutions for diverse power and grounding needs. PANDUIT® offers a wide assortment of PAN-LUG™ Power and Grounding Connectors to meet customer needs and today's application requirements.

System Overview

Terminals

Disconnects

Splices

Ferrules

Compression Connectors

Crimping Tools

Mechanical Connectors

Grounding Connectors

Support Products

Technical Info

Index

System Overview

Features and Benefits — PAN-LUG™ Mechanical Connectors

Terminals

Copper Split Bolt Connectors

Part number and conductor range marked on part for easy identification

Hex head with large wrench flats for easy assembly

Waxed body to prohibit binding of contact pad or nut

250 kcmil and larger sizes have contact serrations for higher pull-out strength

Extra-long body available to connect two taps with one run

Made from high strength copper alloy

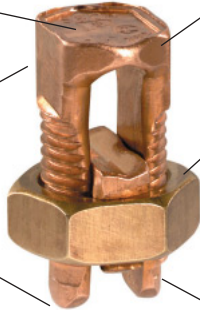

Cast Copper Connectors

Made from high strength copper alloy

Inspection windows to assure complete conductor insertion

Serrated barrel available for high pull-out strength

Part number and conductor range marked on part for easy identification

Flat bottom allows full contact surface mounting

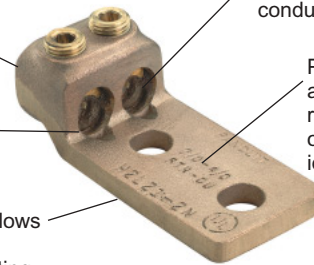

Ferrules

Stamped and Formed Copper Connectors

Made from high strength, electrolytic copper alloy

Hex head bolt (slotted set screw used up through 1/0 AWG sizes) for assembly with a wrench or screwdriver

Part number and conductor range marked on part for easy identification

Two styles of tongues available: fixed and floating

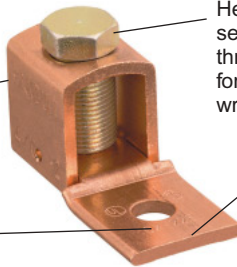

Aluminum Connectors

Dual rated for aluminum or copper conductors

Hex socket set screw (slotted set screw used up through 2/0 AWG sizes) for assembly with a wrench or screwdriver

Made from high strength, extruded aluminum alloy

Electro tin plated to inhibit corrosion

Part number and conductor range marked on part for easy identification

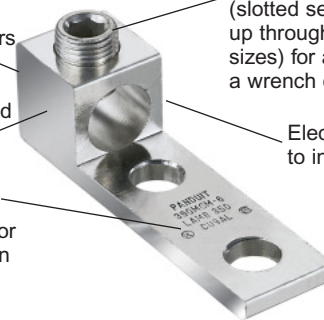

Mechanical Connectors

Multi-Tap Connectors

Hex socket set screws (slotted set screw for smallest size) for assembly with a wrench or screwdriver

Clear PVC insulation for visual inspection of the complete conductor insertion

Pre-insulated aluminum body to eliminate the need for taping

Dual sided conductor entry

Factory pre-filled with oxide inhibitor to prevent oxidation













Made from high strength, extruded aluminum alloy



Technical Info

Index

Selection Guide — PAN-LUG™ Mechanical Connectors, Cast Copper

UL LISTED	Mechanical Connector Type	Stud Hole Size (In.)	Copper Code Conductor Size																						
			#14 AWG	#12 AWG	#10 AWG	#8 AWG	#6 AWG	#4 AWG	#2 AWG	#1 AWG	1/0 AWG	2/0 AWG	3/0 AWG	4/0 AWG	250 kcmil	300 kcmil	350 kcmil	500 kcmil	600 kcmil	750 kcmil	800 kcmil	1000 kcmil			
			PANDUIT® Part Number																						
 <i>Pg. H12</i>	One-Hole, Straight Tongue HL	1/4	HL1-25-X ■ *			HL4-1-X ■ *		HL8-1-X*		HL13-1-5*															
		3/8								HL13-1-5*		HL21-1-5													
		1/2										HL30-1-2		HL50-1-2											
 <i>Pg. H13</i>	One-Hole, Straight Tongue HLB	1/4	HLB4-1-X ■ *																						
		1/4	HLA4-1-90-X ■ *			HLA8-1-90-X*		HLA13-1-90-5																	
 <i>Pg. H13</i>	One-Hole, Straight Tongue HLA-90	1/4	HLA4-1-90-X ■ *			HLA8-1-90-X*		HLA13-1-90-5																	
		3/8						HLA21-1-90-5																	
 <i>Pg. H14</i>	Two-Hole, Straight Tongue HL-2	1/4	HL1-2-25-X ■ *			HL4-2-X ■ *		HL8-2-X*		HL13-2-5															
		5/16								HL13-2-5		HL21-2-5													
		3/8										HL30-2-2		HL50-2-2											
 <i>Pg. H15</i>	Two-Hole, Straight Tongue HL-2N	1/2				HL8-2N-X*		HL13-2N-5		HL21-2N-5		HL30-2N-2													
		1/2				H2L4-2N-X ■ *		H2L8-2N-2*		H2L13-2N-2		H2L21-2N-2		H2L30-2N-1											
 <i>Pg. H17</i>	Two-Way Connector HC	—	HC4-3 ■ *			HC8-3*		HC13-3		HC21-1		HC30-1		HC50-1											
		—				HHL8-2N-X*		HHL13-2N-5		HHL21-2N-5		HHL30-2N-1													
		1/2																							
 <i>Pg. H12</i>	One-Hole, Straight Tongue PNL	#10	PNL-8-C ■ *																						
		1/4	PNL-4-C ■ *			PNL-1/0-L*		PNL-250-Q*		PNL-500-3*															
		5/16				PNL-1/0-L*		PNL-250-Q*		PNL-500-3*															
		3/8				PNL-1/0-L*		PNL-250-Q*		PNL-500-3*															
		1/2																PNL-1000-3							
 <i>Pg. H11</i>	One-Hole, Straight Tongue ML	3/16	ML8-C ■ *																						
		1/4	ML4-C ■ *			ML1/0-L*		ML250-Q																	
		5/16				ML1/0-L*		ML250-Q																	
		3/8				PNL-1/0-2-L*		PNL-250-2-Q*		PNL-500-2-3*		PNL-1000-2-3													
 <i>Pg. H14</i>	Two-Hole, Straight Tongue PNL-2	3/8				PNL-1/0-2-L*		PNL-250-2-Q*		PNL-500-2-3*		PNL-1000-2-3													
		1/2				PNLC-1/0-3*		PNLC-250-1*		PNLC-500-1*															
 <i>Pg. H17</i>	Two-Way Connector PNLC	—				PNLC-1/0-3*		PNLC-250-1*		PNLC-500-1*															







‡Type PNL is also CSA Certified, Type PNLC is not UL Listed or CSA Certified.
 ■Uses slotted set screw. *Denotes minimum conductor size is solid conductor.

- System Overview
- Terminals
- Disconnects
- Splices
- Ferrules
- Compression Connectors
- Crimping Tools
- Mechanical Connectors
- Grounding Connectors
- Support Products
- Technical Info
- Index

System Overview

Selection Guide — PAN-LUG™ Mechanical Connectors, Stamped and Formed

Terminals









UL LISTED CS CERTIFIED	Mechanical Connector Type	Current Rating AMPS	Stud Hole Size (In.)	Copper Code Conductor Size																							
				#14 AWG	#12 AWG	#10 AWG	#8 AWG	#6 AWG	#4 AWG	#2 AWG	#1 AWG	1/0 AWG	2/0 AWG	3/0 AWG	4/0 AWG	250 kcmil	350 kcmil	400 kcmil	500 kcmil	600 kcmil	750 kcmil	800 kcmil	1000 kcmil				
				PANDUIT® Part Number																							
	One-Hole, Offset Tongue CB	25	1/8	CB25-18-C ■																							
		50	3/16	CB35-36-C • ■																							
		70	1/4	CBA70-14-C ■																							
		90		CB70-14-C • ■																							
		125	3/8																								
		175		CB175-38-Q																							
		225		5/16	CB225-56-Q																						
		300	3/8																								
400	CB300-38-Q																										
	Two Barrel, One-Hole, Offset Tongue DC	450	3/8	DC450-38-3																							
		600		DC600-38-3																							
	Two-Hole, Offset Tongue CO	450	3/8	DC800-12-3																							
		600		DC600-38-3																							
		800	1/2	DC800-12-3																							
	Two-Hole, Offset Tongue CO	50	3/16	CO35-36-Q • ■ (1)																							
		90	1/4	CO70-14-Q • ■ (1)																							
		125		CO125-14-Q ■ (1)																							
		225	5/16	CO225-56-Q (1)																							
		300	3/8	CO300-38-3 (3)																							
		400		CO400-38-3 (2)																							
	One-Hole, Straight "Fixed" Tongue CX	650	1/2	CO650-12-3 ◆ (2)																							
		35	3/16	CX35-36-C ■																							
		70	1/4	CX70-14-C • ■																							
		125		CX125-14-Q ■																							
		225	5/16	CX225-56-Q																							
		400	3/8	CX400-38-3																							
	One-Hole, Straight Tongue CS	25	1/8	CS25-18-C																							
		50	3/16	CS35-36-C • ■																							
		70	1/4	CSA70-14-C ■																							
		90		CS70-14-C • ■																							
		125	3/8																								
		175		CS175-38-Q																							
		225		5/16	CS225-56-Q																						
		300	3/8	CS300-38-Q																							
		400		CS400-38-3																							
		650	1/2	CS650-12-3																							
	Two-Hole, Straight Tongue CD	50	3/16	CD35-36-Q • ■ (1)																							
		90	1/4	CD70-14-Q ■ (1)																							
		125		CD125-14-Q ■ (1)																							
		225	5/16	CD225-56-Q (1)																							
		300	3/8	CD300-38-3 (1)																							
		400		CD400-38-3 ◆ (2)																							
650	1/2	CD650-12-3 ◆ (2)																									

•Multiple conductor combinations. ◆NEMA hole sizes and spacing.
 ■Uses slotted set screw (1)1.00" stud hole spacing; (2)1.75" stud hole spacing; (3)1.87" stud hole spacing.

Technical Info

Index

Selection Guide — PAN-LUG™ Mechanical Connectors, Aluminum

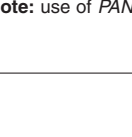
Mechanical Connector Type	Stud Hole Size (In.)	Aluminum/Copper Code Conductor Size																																								
		#14 AWG	#12 AWG	#10 AWG	#8 AWG	#6 AWG	#4 AWG	#2 AWG	#1 AWG	1/0 AWG	2/0 AWG	3/0 AWG	4/0 AWG	250 kcmil	300 kcmil	350 kcmil	500 kcmil	600 kcmil	750 kcmil	800 kcmil	1000 kcmil																					
<i>PANDUIT®</i> Part Number																																										
 <p>Pg. H23</p>  <p>Pg. H23</p>	One Barrel, One-Hole LAMA	1/4	LAMA6-14-Q ■				LAMA2-14-Q ■				LAMA1/0-14-Q ■				LAMA2/0-14-Q ■				LAMA250-56-Q				LAMA300-56-Q				LAMA350-38-Q				LAMA500-38-6				LAMA600-38-6				LAMA600S-38-6 ‡ ^			
		5/16	LAMA250-56-Q				LAMA300-56-Q				LAMA350-38-Q				LAMA500-38-6				LAMA600-38-6				LAMA600S-38-6 ‡ ^																			
		3/8	LAMA250-56-Q				LAMA300-56-Q				LAMA350-38-Q				LAMA500-38-6				LAMA600-38-6				LAMA600S-38-6 ‡ ^																			
		5/8	LAMA250-56-Q				LAMA300-56-Q				LAMA350-38-Q				LAMA500-38-6				LAMA600-38-6				LAMA600S-38-6 ‡ ^																			
	One Barrel, Two-Hole LAMB	1/2	LAMB350-12-6				LAMB600-12-3				LAMB800-12-3 ▲				LAMB1000-12-3 ▲																											
			LAMB350-12-6				LAMB600-12-3				LAMB800-12-3 ▲				LAMB1000-12-3 ▲																											
	 <p>Pg. H24</p>  <p>Pg. H25</p>	Two Barrel, One-Hole LAM2A	1/4	LAM2A1/0-14-6 ■				LAM2A2/0-14-6 ■ ^				LAM2A250-38-6				LAM2A350-12-6				LAM2A600-12-6				LAM2A800-58-6				LAM2A1000-58-6 ^ ‡														
			3/8	LAM2A1/0-14-6 ■				LAM2A2/0-14-6 ■ ^				LAM2A250-38-6				LAM2A350-12-6				LAM2A600-12-6				LAM2A800-58-6				LAM2A1000-58-6 ^ ‡														
		Two Barrel, Two-Hole LAM2B	1/2	LAM2B350-12-3				LAM2B600-12-3				LAM2LB800-12-3 ▲ ‡				LAM2LB1000-12-3 ▲ ‡																										
				LAM2B350-12-3				LAM2B600-12-3				LAM2LB800-12-3 ▲ ‡				LAM2LB1000-12-3 ▲ ‡																										
 <p>Pg. H25</p>	Two Barrel, Two-Hole LAM2SB	3/8	LAM2SB600-38-1				LAM2SB750-38-1																																			
			LAM2SB600-38-1				LAM2SB750-38-1																																			
 <p>Pg. H26</p>  <p>Pg. H26</p>	Three Barrel, Two-Hole LAM3B	1/4	LAM3B2-14-6 ■				LAM3B1/0-38-6 ■				LAM3B3/0-12-3 ■				LAM3B250-12-1				LAM3B350-12-1				LAM3B600-12-1				LAM3LB800-12-1 ▲				LAM3LB1000-12-1 ▲											
		3/8	LAM3B2-14-6 ■				LAM3B1/0-38-6 ■				LAM3B3/0-12-3 ■				LAM3B250-12-1				LAM3B350-12-1				LAM3B600-12-1				LAM3LB800-12-1 ▲				LAM3LB1000-12-1 ▲											
		1/2	LAM3B2-14-6 ■				LAM3B1/0-38-6 ■				LAM3B3/0-12-3 ■				LAM3B250-12-1				LAM3B350-12-1				LAM3B600-12-1				LAM3LB800-12-1 ▲				LAM3LB1000-12-1 ▲											
	Three Barrel, Two-Hole LAM3SB	3/8	LAM3SB600-38-1				LAM3SB750-38-1																																			
			LAM3SB600-38-1				LAM3SB750-38-1																																			
	 <p>Pg. H27</p>  <p>Pg. H27</p>	Three Barrel, Four-Hole LAM3D	1/2	LAM3D3/0-12-3 ■				LAM3D250-12-1				LAM3D350-12-1				LAM3D600-12-1				LAM3LD800-12-1 ▲				LAM3LD1000-12-1 ▲																		
			LAM3D3/0-12-3 ■				LAM3D250-12-1				LAM3D350-12-1				LAM3D600-12-1				LAM3LD800-12-1 ▲				LAM3LD1000-12-1 ▲																			
Four Barrel, Two-Hole LAM4SB		3/8	LAM4SB600-38-1				LAM4SB750-38-1																																			
			LAM4SB600-38-1				LAM4SB750-38-1																																			
 <p>Pg. H28</p>	Four Barrel, Four-Hole LAM4D	1/2	LAM4D250-12-1				LAM4D350-12-1				LAM4D600-12-1				LAM4LD800-12-1 ▲																											
			LAM4D250-12-1				LAM4D350-12-1				LAM4D600-12-1				LAM4LD800-12-1 ▲																											
			LAM4D250-12-1				LAM4D350-12-1				LAM4D600-12-1				LAM4LD800-12-1 ▲																											

‡LAMA600S-38-6 can also be used with (2) 250 kcmil-1/0 AWG conductors. ■Uses slotted set screw.
▲Uses double set screws. ^Not CSA Certified. ‡‡Not UL Listed.

Note: use of *PANDUIT®* oxide inhibiting joint compound CMP-100 is recommended for use with aluminum mechanical connectors.

- System Overview
- Terminals
- Disconnects
- Splices
- Ferrules
- Compression Connectors
- Crimping Tools
- Mechanical Connectors
- Grounding Connectors
- Support Products
- Technical Info
- Index

System Overview

Selection Guide — PAN-LUG™ Mechanical Connectors, Split Bolts and Multi-Taps

Terminals

Copper Split Bolt Connectors

For Use with Copper Code Conductors



PANDUIT® Part Number	Copper Conductor Range**		PANDUIT® Part Number	Copper Conductor Range**	
	Min.	Max.		Min.	Max.
SBC8-C	#12 SOL	#8 STR	SBC1/0-L	#4 SOL	1/0 STR
SBC8L-C ^	#12 SOL	#8 STR	SBC2/0-Q	#2 SOL	2/0 STR
SBC6S-C	#10 SOL	#6 SOL	SBC3/0-Q	#2 SOL	3/0 STR
SBC6SL-C ^	#10 SOL	#6 SOL	SBC250-Q	1/0 SOL	250 kcmil
SBC4S-C	#8 SOL	#4 SOL	SBC350-1	4/0 STR	350 kcmil
SBC4SL-C ^	#8 SOL	#4 SOL	SBC500-1	250 kcmil	500 kcmil
SBC3-C	#6 SOL	#2 SOL	SBC750-1	350 kcmil	750 kcmil
SBC2-C	#6 SOL	#2 STR	SBC1000-1	500 kcmil	1000 kcmil
SBC2L-C ^	#6 SOL	#2 STR			

Pg. H7

^Not CSA Certified.

**The conductor sizes shown are for equal run and tap combinations for both solid and stranded unless otherwise listed.

Splices

Tin Plated Copper Split Bolt Connectors

For Use with All Combinations of Copper and Aluminum Code Conductors



PANDUIT® Part Number	Copper and Alum. Conductor Range		Min. Tap w/ One Max. Main	Alum. Conductor Steel Reinforced	
	Range of Equal Main and Tap			Range of Main or Tap	
	Min.	Max.		Min.	Max.
SBCT8-C	#14 STR	#8 STR	#14 STR	—	8
SBCT6-C	#10 STR	#6 STR	#10 SOL	—	6
SBCT3-C	#8 SOL	#3 STR	#8 SOL	6	4
SBCT2-C	#8 SOL	#2 STR	#8 SOL	6	2
PANDUIT® Part Number	Copper Conductor Range		Alum. Conductor Range	Alum. Conductor Range	
	Min.	Max.		Aluminum	ACSR
SBCT10-C	#16 STR	#10 STR	#16 STR	#16 STR-#10 STR	—
SBCT1/0-L	#6 SOL	1/0 STR	#10 SOL	#6 SOL-1/0 STR	6-1
SBCT2/0-Q	#6 STR	2/0 STR	#10 SOL	#6 STR-2/0 STR	6-1/0
SBCT3/0-Q	#4 STR	3/0 STR	#6 SOL	#4 STR-3/0 STR	6-2/0
SBCT250-Q	#4 STR	250 kcmil	#4 STR	#4 STR-250 kcmil	4-4/0
SBCT350-1	3/0 STR	350 kcmil	#1 SOL	3/0 STR-350 kcmil	2/0-350
SBCT500-1	3/0 STR	500 kcmil	1/0 STR	3/0 STR-500 kcmil	2/0-477.18/1
SBCT750-1	250 kcmil	750 kcmil	2/0 STR	250-750 kcmil	4/0-666.6
SBCT1000-1	350 kcmil	1000 kcmil	4/0 STR	350-1000 kcmil	300-900

Pg. H8

Mechanical Connectors

Dual Rated Aluminum Split Bolt Connectors

For Use with Aluminum and Copper Code Conductor Combinations



PANDUIT® Part Number	Aluminum to Aluminum, Aluminum to Copper, Copper to Copper Conductors					
	Max. Run to Max. Tap		Min. Run to Min. Tap		Max. Run to Min. Tap	
	Min.	Max.	Min.	Max.	Min.	Max.
SBA6-C	#6 STR	#6 STR	#10 SOL	#10 SOL	#6 STR	#10 SOL
SBA4-C	#4 STR	#4 STR	#8 SOL	#10 SOL	#4 STR	#10 SOL
SBA2-C	#2 STR	#2 STR	#6 SOL	#8 STR	#2 STR	#8 STR
SBA1/0-Q	1/0 STR	1/0 STR	#2 STR (Compact)	#8 SOL	1/0 STR	#8 SOL
SBA2/0-Q	2/0 STR	2/0 STR	#2 STR (Compact)	#8 STR	2/0 STR	#8 STR
SBA4/0-Q	4/0 STR	4/0 STR	#2 STR (Compact)	#6 STR	4/0 STR	#6 STR
SBA350-1 ^	350 kcmil	350 kcmil	1/0 STR (Compact)	#4 STR	350 kcmil	#4 STR
SBA500-1 ^	500 kcmil	500 kcmil	400 kcmil (Compact)	#2 STR (Compact)	500 kcmil	#2 STR (Compact)

Pg. H9

^Not CSA Certified.

Technical Info

Multi-Tap Insulated Multiple Cable Connector Blocks



Number of Conductor Ports	Copper and Aluminum Conductor Range				
	#4-#14 AWG STR, #10-#14 AWG SOL	2/0-#14 AWG STR, #10-#14 AWG SOL	250 kcmil-#6 AWG STR	350 kcmil-#10 AWG STR, #10 AWG SOL	500 kcmil-#6 AWG STR
	PANDUIT® Part Number				
2	PCSB4-2-12	PCSB2/0-2-12	PCSB250-2-6	PCSB350-2-4	PCSB500-2-4
3	PCSB4-3-12	PCSB2/0-3-6	PCSB250-3-6	PCSB350-3-4	PCSB500-3-3
4	PCSB4-4-6	PCSB2/0-4-6	PCSB250-4-6	PCSB350-4-3	PCSB500-4-2
5	PCSB4-5-6	PCSB2/0-5-6	PCSB250-5-4	PCSB350-5-3	PCSB500-5-2
6	PCSB4-6-6	PCSB2/0-6-6	PCSB250-6-4	PCSB350-6-2	PCSB500-6-2
7	PCSB4-7-4	PCSB2/0-7-4	PCSB250-7-3	PCSB350-7-2	PCSB500-7-2
8	PCSB4-8-4	PCSB2/0-8-4	PCSB250-8-3	PCSB350-8-2	PCSB500-8-2

Pg. H31



Split Bolt, Copper

For Use with Copper Code Conductors

Type SBC

- Made from high strength copper alloy to resist corrosion and provide premium electrical and mechanical performance
- Offered with extra long body to allow connection of one or two taps to a single run conductor
- Wire range-taking capability minimizes inventory requirements
- True hex design for body and nut hex provides correct fit with socket, box or open end wrenches resulting in proper torquing of electrical connection
- Pressure bar provides secure connection on a full range of conductor combinations used with each connector assuring premium wire pull-out strength
- UL Listed and CSA Certified for use up to 600V and temperature rated 90°C

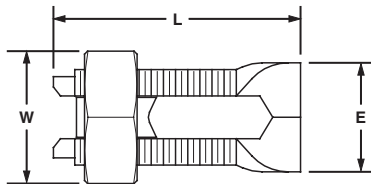

Part Number	Copper Conductor			Max. Conductor		Figure Dimensions (In.)			Tightening Torque (In.-Lbs.)	Std. Pkg. Qty.
	Range of Equal Run & Tap**		Min. Tap with One Max. Run	Copperweld		E	W	L		
	Min.	Max.		STR	TYPE A					
SBC8-C	#12 SOL	#8 STR	#16 STR	—	—	.38	.50	.84	80	100
SBC8L-C*	#12 SOL	#8 STR	#16 STR	—	—	.38	.50	.84	80	100
SBC6S-C	#10 SOL	#6 SOL	#16 SOL	—	—	.44	.63	1.05	165	100
SBC6SL-C*	#10 SOL	#6 SOL	#16 SOL	—	—	.44	.63	1.11	165	100
SBC4S-C	#8 SOL	#4 SOL	#16 SOL	3 No. 12	8A	.50	.69	1.05	165	100
SBC4SL-C*	#8 SOL	#4 SOL	#16 SOL	3 No. 12	8A	.50	.69	1.27	165	100
SBC3-C	#6 SOL	#2 SOL	#12 SOL	3 No. 9	5A	.63	.81	1.32	275	100
SBC2-C	#6 SOL	#2 STR	#14 STR	3 No. 7	3A	.63	.81	1.32	275	100
SBC2L-C*	#6 SOL	#2 STR	#14 STR	3 No. 7	3A	.63	.81	1.55	275	100
SBC1/0-L	#4 SOL	1/0 STR	#14 SOL	3 No. 6	2A	.69	.88	1.64	385	50
SBC2/0-Q	#2 SOL	2/0 STR	#14 STR	3 No. 6	—	.75	1.00	1.82	385	25
SBC3/0-Q	#2 SOL	3/0 STR	#12 SOL	7 No. 7	—	.88	1.13	1.97	500	25
SBC250-Q	1/0 SOL	250 kcmil	#10 SOL	7 No. 5	—	1.00	1.31	2.09	650	25
SBC350-1	4/0 STR	350 kcmil	#8 SOL	19 No. 7	—	1.50	1.63	2.63	650	1
SBC500-1	250 kcmil	500 kcmil	#8 SOL	19 No. 6	—	1.63	1.81	3.00	825	1
SBC750-1	350 kcmil	750 kcmil	#8 SOL	19 No. 5	—	1.94	2.13	3.75	1000	1
SBC1000-1	500 kcmil	1000 kcmil	#8 SOL	—	—	2.25	2.50	4.00	1100	1

*Long body accommodates two tap conductors with single run; not CSA Certified.

**The conductor sizes shown are for equal run and tap combinations for both solid and stranded unless otherwise listed.

System Overview

Terminals

Disconnects

Splices

Ferrules

Compression Connectors

Crimping Tools

Mechanical Connectors

Grounding Connectors

Support Products

Technical Info

Index

PANDUIT® TERMINATION SOLUTIONS

System Overview



Split Bolt, Copper, Tin Plated

For Specified Combinations of Copper and Aluminum Code Conductors

Type SBCT

Terminals

- Made from high strength copper alloy to provide premium electrical and mechanical performance
- Tin plated to inhibit corrosion and oxidation
- Offered with dual rating for use with aluminum or copper conductors
- Wire range-taking capability minimizes inventory requirements

- True hex design for body and nut hex provides correct fit with socket, box or open end wrenches resulting in proper torquing of electrical connection
- Free floating pressure bar separates conductors of dissimilar materials for secure connection on a full range of conductor combinations
- UL Listed and CSA Certified for use up to 600V and UL temperature rated 90°C

Disconnects

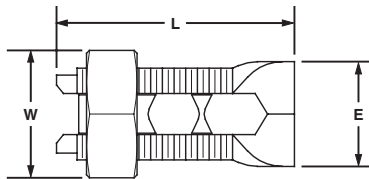

Splices

Ferrules

Part Number	Copper and Aluminum Code Conductor			ACSR Range	Max. Conductor		Figure Dimensions (In.)			Tightening Torque (In.-Lbs.)	Std. Pkg. Qty.
	Range of Equal Run and Tap		Min. Tap with One Max. Run		Copperweld		E	W	L		
	Min.	Max.			STR	Type A					

UL Listed and CSA Certified with Copper and Aluminum Conductors

SBCT8-C	#14 STR	#8 STR	#14 STR	#8	—	—	.49	.62	1.10	165	100
SBCT6-C	#10 STR	#6 STR	#10 SOL	#6	3 No. 12	8A	.56	.68	1.28	165	100
SBCT3-C	#8 SOL	#3 STR	#8 SOL	#6 – #4	3 No. 9	5A	.69	.80	1.55	275	100
SBCT2-C	#8 SOL	#2 STR	#8 SOL	#6 – #2	3 No. 7	3A	.69	.80	1.54	275	100

UL Listed and CSA Certified with Copper Code Conductors Only

SBCT10-C	#16 STR	#10 STR	#16 STR	—	—	—	.38	.49	.87	80	100
SBCT1/0-L	#6 SOL	1/0 STR	#10 SOL	#6 – #1	3 No. 6	—	.75	.86	1.63	385	50
SBCT2/0-Q	#6 STR	2/0 STR	#10 SOL	#6 – 1/0	3 No. 5	—	.82	.99	1.82	385	25
SBCT3/0-Q	#4 STR	3/0 STR	#6 SOL	#6 – 2/0	7 No. 7	—	.88	1.12	2.01	500	25
SBCT250-Q	#4 STR	250 kcmil	#4 STR	#4 – 4/0	7 No. 5	—	1.00	1.27	1.37	650	25
SBCT350-1	3/0 STR	350 kcmil	#1 SOL	2/0 – 350	19 No. 7	—	1.50	1.63	2.57	650	1
SBCT500-1	3/0 STR	500 kcmil	1/0 STR	2/0 – 477 18/1	19 No. 6	—	1.65	1.81	3.00	825	1
SBCT750-1	250 kcmil	750 kcmil	2/0 STR	4/0 – 666.6	19 No. 5	—	1.93	2.11	3.78	1000	1
SBCT1000-1	350 kcmil	1000 kcmil	4/0 STR	300 – 900	—	—	2.29	2.53	4.02	1100	1

The use of PANDUIT® oxide inhibiting joint compound (CMP-100) is recommended. See [pages H33, F118](#).

Grounding Connectors

Support Products

Technical Info

Index



Split Bolt, Aluminum

For Use with Copper and Aluminum Code Conductors

Type SBA

- Made from lightweight, durable aluminum alloy to resist corrosion and provide premium electrical and mechanical performance
- Dual rated for use with aluminum to aluminum, aluminum to copper and copper to copper conductor combinations
- Tin plated to inhibit corrosion and oxidation
- Wire range-taking capability minimizes inventory requirements
- True hex design for body and nut hex provides correct fit with socket, box or open end wrenches resulting in proper torquing of electrical connection
- Free floating pressure bar separates conductors of dissimilar materials for secure connection on a full range of conductor combinations
- UL Listed and CSA Certified for use up to 600V and temperature rated 90° C

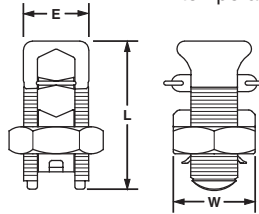

Part Number	Max. Run to Max. Tap	Min. Run to Min. Tap	Max. Run to Min. Tap	Figure Dimensions (In.)			Tightening Torque (In.-Lbs.)	Std. Pkg. Qty.
				E	W	L		
SBA6-C	#6 STR – #6 STR	#10 SOL – #10 SOL	#6 STR – #10 SOL	.56	.75	1.58	165	100
SBA4-C	#4 STR – #4 STR	#8 SOL – #10 SOL	#4 STR – #10 SOL	.62	.81	1.38	165	100
SBA2-C	#2 STR – #2 STR	#6 SOL – #8 STR	#2 STR – #8 STR	.69	.94	1.58	275	100
SBA1/0-Q	1/0 STR – 1/0 STR	#2 STR (Compact) – #8 SOL	1/0 STR – #8 SOL	.75	1.00	1.92	385	25
SBA2/0-Q	2/0 STR – 2/0 STR	#2 STR (Compact) – #8 STR	2/0 STR – #8 STR	.88	1.12	1.92	385	25
SBA4/0-Q	4/0 STR – 4/0 STR	#2 STR (Compact) – #6 STR	4/0 STR – #6 STR	1.13	1.49	2.54	500	25
SBA350-1	350 kcmil – 350 kcmil	1/0 STR (Compact) – #4 STR	350 kcmil – #4 STR	1.50	1.69	3.24	650	1
SBA500-1	500 kcmil – 500 kcmil	400 kcmil (Compact) – #2 STR (Compact)	500 kcmil – #2 STR (Compact)	1.73	2.00	3.62	825	1

The use of PANDUIT® oxide inhibiting joint compound (CMP-100) is recommended. See [pages H33, F118](#).



Two Bolt Connector, Bronze

For Use with Copper Code Conductors

Type VT

- Made from high strength bronze for heavy duty connections and to inhibit corrosion
- Cap swivels for easy installation of conductors
- Rubber washer retains hardware to connector and eliminates loose parts
- High strength silicon-bronze hardware provides premium mechanical performance when assembled to conductor
- Wire range-taking capability minimizes inventory requirements
- UL Listed for use up to 600V and 90°C temperature rated

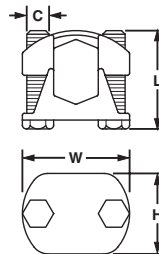

Part Number	Copper Conductor Size		Figure Dimensions (In.)				Hex Size (In.)	Tightening Torque (In.-Lbs.)	Std. Pkg. Qty.
	Run	Tap	L	W	H	C			
VT-0-Q	#2 STR – 1/0 STR	#10 STR – 1/0 STR	1.50	1.44	.94	.31	1/2	180	25
VT-1-Q	#2 STR – 2/0 STR	#10 STR – 2/0 STR	1.50	1.56	1.13	.31	1/2	180	25
VT-2-Q	1/0 STR – 4/0 STR	#10 STR – 4/0 STR	1.75	1.84	1.34	.38	9/16	240	25
VT-3-12	250 kcmil – 350 kcmil	#10 STR – 350 kcmil	2.00	2.31	1.63	.50	3/4	480	12
VT-4-12	250 kcmil – 500 kcmil	#10 STR – 500 kcmil	2.25	2.44	1.69	.50	3/4	480	12
VT-5-6	400 kcmil – 800 kcmil	3/0 STR – 800 kcmil	2.50	2.69	1.88	.50	9/16	480	6
VT-6-6	500 kcmil – 1000 kcmil	3/0 STR – 1000 kcmil	2.75	3.06	2.25	.63	15/16	660	6

System Overview



Two Bolt Connector, Bronze, Tin Plated

For Use with Copper and Aluminum Code Conductors

Type VTA

- Made from high strength bronze for heavy duty connections
- Tin plated to inhibit corrosion and oxidation
- Cap swivels for easy installation of conductors
- Rubber washer retains hardware to connector and eliminates loose parts
- High strength silicon-bronze hardware provides premium mechanical performance when assembled to conductor
- Offered for use with aluminum conductors, but not UL Listed
- UL Listed for use up to 600V and 90°C temperature rated when used with copper code conductor

Disconnects

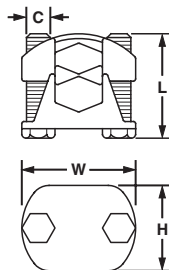

Splices

Ferrules

Part Number	Max. Copper Conductor Size	Max. Aluminum Conductor Size*	Copperweld Solid	Figure Dimensions (In.)				Hex Size (In.)	Tightening Torque (In.-Lbs.)	Std. Pkg. Qty.
				L	W	H	C			
VTA-0-Q	2/0 SOL – 1/0 STR	1/0 STR – 1 ACSR	2/0	1.25	1.44	.94	5/16	1/2	180	25
VTA-1-Q	3/0 SOL – 2/0 STR	—	3/0	1.50	1.56	1.13	5/16	1/2	180	25
VTA-2-Q	4/0 SOL – 4/0 STR	—	4/0	1.75	1.84	1.34	3/8	9/16	240	25
VTA-3-12	350 kcmil	—	—	2.00	2.31	1.63	1/2	3/4	480	12
VTA-4-12	500 kcmil	—	—	2.25	2.44	1.69	1/2	3/4	480	12
VTA-5-6	800 kcmil	—	—	2.50	2.69	1.88	1/2	3/4	480	6
VTA-6-6	1000 kcmil	—	—	2.75	3.06	2.25	5/8	15/16	660	6

*Not UL Listed.

Crimping Tools

Mechanical Connectors

Grounding Connectors

Support Products

Technical Info

Index

One-Hole, Straight Tongue, Barrel Post Lug

For Use with Copper Code Conductors

Type ML

- Made from high strength electrolytic copper to provide premium electrical and mechanical performance
- Compact design saves space
- Wire range-taking capability minimizes inventory requirements
- Inspection window to visually assure full conductor insertion
- Plated steel set screw provides high strength, durable electrical contact between conductor and connector
- Flat bottom allows for complete contact with mounting surface
- UL Listed for use up to 600V and temperature rated 90°C

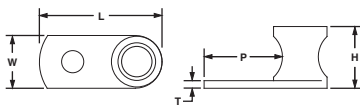

Part Number	Copper Conductor Size Range	Stud Hole Size (In.)	Hex Key Size (In.)	Figure Dimensions (In.)					Tightening Torque (In.-Lbs.)	Std. Pkg. Qty.
				L	W	H	T	P		
ML8-C	#14 SOL – #8 STR	3/16	**	.81	.38	.38	.08	.48	25	100
ML4-C	#14 SOL – #4 STR	1/4	**	1.13	.50	.53	.09	.63	45	100
ML1/0-L	#8 SOL – 1/0 STR	5/16	1/4	1.50	.75	.75	.09	.80	200	50
ML250-Q	#6 STR – 250 kcmil	3/8	1/4	1.94	.94	1.06	.13	1.00	200	25
ML500-3	4/0 AWG – 500 kcmil	1/2	3/8	2.97	1.38	1.44	.13	2.00	375	3

**Uses slotted head set screw.

One-Hole, Straight Tongue, Tin Plated, Barrel Post Lug

For Use with Copper Code Conductors

Type ML-T

- Made from high strength, electrolytic copper to provide premium electrical and mechanical performance
- Tin plated to inhibit corrosion
- Compact design saves space
- Wire range-taking capability minimizes inventory requirements
- Inspection window to visually assure full conductor insertion
- Plated steel set screw provides high strength, durable electrical contact between conductor and connector
- Flat bottom allows for complete contact with mounting surface
- UL Listed for use up to 600V and temperature rated 90°C

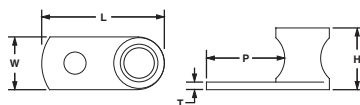

Part Number	Copper Conductor Size Range	Stud Hole Size (In.)	Hex Key Size (In.)	Figure Dimensions (In.)					Tightening Torque (In.-Lbs.)	Std. Pkg. Qty.
				L	W	H	T	P		
ML8T-C	#14 SOL – #8 STR	3/16	**	.81	.38	.38	.08	.48	25	100
ML4T-C	#14 SOL – #4 STR	1/4	**	1.13	.50	.53	.09	.63	45	100
ML1/0T-L	#8 SOL – 1/0 STR	5/16	1/4	1.50	.75	.75	.09	.80	200	50
ML250T-Q	#6 STR – 250 kcmil	3/8	1/4	1.94	.94	1.06	.13	1.00	200	25

**Uses slotted head set screw.

System Overview

Terminals

Disconnects

Splices

Ferrules

Compression Connectors

Crimping Tools

Mechanical Connectors

Grounding Connectors

Support Products

Technical Info

Index

System Overview



One-Hole, Straight Tongue Lug

For Use with Copper Code Conductors

Terminals

Type PNL

- Cast from high strength corrosion resistant copper alloy to provide premium electrical and mechanical performance
- Compact design saves space
- Wire range-taking capability minimizes inventory requirements
- Inspection window to visually assure full conductor insertion
- Plated steel set screw provides high strength, durable electrical contact between conductor and connector
- Flat bottom allows for complete contact with mounting surface
- UL Listed and CSA Certified for use up to 600V and UL temperature rated 90°C

Disconnects



Part Number	Copper Conductor Size Range	Stud Hole Size (In.)	Hex Key Size (In.)	Figure Dimensions (In.)					Tightening Torque (In.-Lbs.)	Std. Pkg. Qty.
				L	W	H	T	P		
PNL-8-C	#14 SOL – #8 STR	#10	**	.88	.38	.44	.09	.50	25	100
PNL-4-C	#14 SOL – #4 STR	1/4	**	1.25	.53	.56	.14	.66	45	100
PNL-1/0-L	#8 SOL – 1/0 STR	5/16	1/4	1.59	.73	.78	.14	.85	200	50
PNL-250-Q	#6 SOL – 250 kcmil	3/8	5/16	1.97	.94	1.05	.13	1.00	275	25
PNL-500-3	#4 SOL – 500 kcmil	1/2	3/8	3.00	1.38	1.47	.25	1.63	375	3
PNL-1000-3	500 kcmil – 1000 kcmil	1/2	1/2	3.88	1.75	2.00	.38	2.13	500	3

**Uses slotted head set screw.

Splices

Ferrules

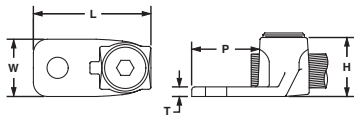

Compression Connectors



One-Hole, Straight Tongue Lug with Internal Pressure Plate

For Use with Copper Code Conductors

Crimping Tools

Type HL

- Cast from high strength corrosion resistant copper alloy to provide premium electrical and mechanical performance
- Compact design saves space
- Wire range-taking capability minimizes inventory requirements
- Internal pressure plate provides uniform clamping force on conductor for premium electrical performance
- Plated steel set screw provides high strength, durable electrical contact between conductor and connector
- Flat bottom allows for complete contact with mounting surface
- Inspection window to visually assure full conductor insertion
- UL Listed for use up to 600V and temperature rated 90°C

Mechanical Connectors



Part Number	Copper Conductor Size Range	Stud Hole Size (In.)	Hex Key Size (In.)	Figure Dimensions (In.)					Tightening Torque (In.-Lbs.)	Std. Pkg. Qty.
				L	W	H	T	P		
HL1-25-X	#14 SOL – #8 STR	1/4	**	1.25	.56	.79	.19	.63	20	10
HL4-1-X	#8 SOL – #4 STR	1/4	**	1.25	.56	.79	.19	.63	35	10
HL8-1-X	#4 SOL – #1 STR	1/4	7/16	1.56	.75	.90	.22	.69	100	10
HL13-1-5	#1 STR – 2/0 STR	3/8	9/16	1.88	.81	1.14	.22	.88	250	5
HL21-1-5	2/0 STR – 4/0 STR	3/8	9/16	2.19	1.00	1.31	.25	1.00	250	5
HL30-1-2	4/0 STR – 300 kcmil	1/2	5/8	2.50	1.06	1.47	.31	1.25	350	2
HL50-1-2	300 kcmil – 500 kcmil	1/2	3/4	3.00	1.38	1.65	.34	1.50	480	2

**Uses slotted head set screw.

Grounding Connectors

Support Products

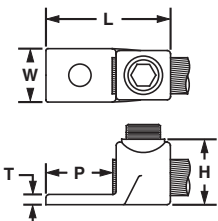

Technical Info

Index



One-Hole, Straight Tongue, Flag Lug

For Use with Copper Code Conductors

Type HLB

- Provides connection of conductor at right angles to terminal bar
- Cast from high strength corrosion resistant copper alloy to provide premium electrical and mechanical performance
- Compact design saves space
- Wire range-taking capability minimizes inventory requirements
- Internal pressure plate provides uniform clamping force on conductor for premium electrical performance
- Flush bottom allows for complete contact with mounting surface
- Inspection window to visually assure full conductor insertion
- UL Listed for use up to 600V and temperature rated 90°C

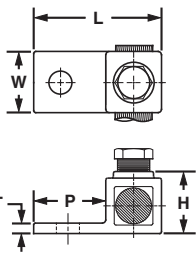

Part Number	Copper Conductor Size Range	Stud Hole Size (In.)	Hex Key Size (In.)	Figure Dimensions (In.)					Tightening Torque (In.-Lbs.)	Std. Pkg. Qty.
				L	W	H	T	P		
HLB4-1-X	#8 SOL – #4 STR	1/4	**	1.25	.50	.79	.19	.63	35	10

**Uses slotted head set screw.



One-Hole, Straight Tongue, 90° Lug

For Use with Copper Code Conductors

Type HLA-90

- Provides connection of conductor at right angles to terminal bar
- Cast from high strength corrosion resistant copper alloy to provide premium electrical and mechanical performance
- Compact design saves space
- Wire range-taking capability minimizes inventory requirements
- Internal pressure plate provides uniform clamping force on conductor for premium electrical performance
- Flush bottom allows for complete contact with mounting surface
- Inspection window to visually assure full conductor insertion
- UL Listed for use up to 600V and temperature rated 90°C

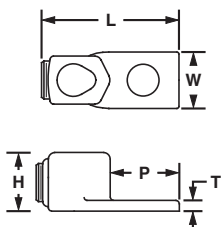

Part Number	Copper Conductor Size Range	Stud Hole Size (In.)	Hex Key Size (In.)	Figure Dimensions (In.)					Tightening Torque (In.-Lbs.)	Std. Pkg. Qty.
				L	W	H	T	P		
HLA4-1-90-X	#8 SOL – #4 STR	1/4	**	1.81	.56	.73	.19	.63	35	10
HLA8-1-90-X	#4 SOL – #1 STR	1/4	7/16	1.50	.75	.75	.22	.69	100	10
HLA13-1-90-5	#1 STR – 2/0 STR	3/8	9/16	2.38	.81	1.00	.22	.88	250	5
HLA21-1-90-5	2/0 STR – 4/0 STR	3/8	9/16	2.69	1.00	1.14	.25	1.00	250	5

**Uses slotted head set screw.

System Overview

Terminals

Disconnects

Splices

Ferrules

Compression Connectors

Crimping Tools

Mechanical Connectors

Grounding Connectors

Support Products

Technical Info

Index

System Overview



Two-Hole, Straight Tongue Lug

For Use with Copper Code Conductors

Type PNL-2

- Cast from high strength corrosion resistant copper alloy to provide premium electrical and mechanical performance
- Wire range-taking capability minimizes inventory requirements
- Inspection window to visually assure full conductor insertion
- Plated steel set screw provides high strength, durable electrical contact between conductor and connector
- Flat bottom allows for complete contact with mounting surface
- UL Listed for use up to 600V and temperature rated 90°C
- Available with NEMA hole sizes and spacing

Terminals

Disconnects

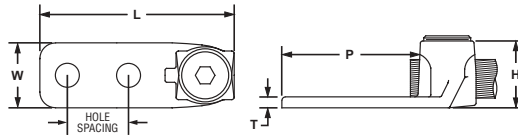

Splices

Part Number	Copper Conductor Size Range	Stud Hole Size (In.)	Stud Hole Spacing (In.)	Hex Key Size (In.)	Figure Dimensions (In.)					Tightening Torque (In.-Lbs.)	Std. Pkg. Qty.
					L	W	H	T	P		
PNL-1/0-2-L	#8 SOL – 1/0 STR	5/16	1.00	1/4	2.75	.75	.84	.19	2.00	200	50
PNL-250-2-Q	#6 SOL – 250 kcmil	3/8	1.00	1/4	2.88	.94	1.03	.22	2.02	200	25
PNL-500-2-3	#4 SOL – 500 kcmil	3/8	1.00	3/8	3.38	1.38	1.47	.31	2.00	375	3
PNL-1000-2-3	500 kcmil – 1000 kcmil	1/2	1.50	3/8	4.88	1.75	2.00	.38	3.13	375	3

Ferrules

Compression Connectors



Two-Hole, Straight Tongue Lug with Internal Pressure Plate

For Use with Copper Code Conductors

Type HL-2

- Cast from high strength corrosion resistant copper alloy to provide premium electrical and mechanical performance
- Wire range-taking capability minimizes inventory requirements
- Internal pressure plate provides uniform clamping force on conductor for premium electrical performance
- Plated steel set screw provides high strength, durable electrical contact between conductor and connector
- Inspection window to visually assure full conductor insertion
- Flat bottom allows for complete contact with mounting surface
- UL Listed for use up to 600V and temperature rated 90°C

Crimping Tools

Mechanical Connectors

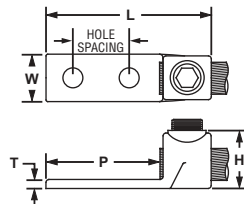

Grounding Connectors

Part Number	Copper Conductor Size Range	Stud Hole Size (In.)	Stud Hole Spacing (In.)	Hex Key Size (In.)	Figure Dimensions (In.)					Tightening Torque (In.-Lbs.)	Std. Pkg. Qty.
					L	W	H	T	P		
HL1-2-25-X	#14 SOL – #8 STR	1/4	.63	**	2.00	.56	.70	.19	1.25	20	10
HL4-2-X	#8 SOL – #4 STR	1/4	.63	**	2.00	.56	.69	.18	1.25	35	10
HL8-2-X	#4 SOL – #1 STR	1/4	.75	7/16	2.44	.75	.92	.22	1.50	100	10
HL13-2-5	#1 STR – 2/0 STR	5/16	1.00	9/16	2.88	.81	1.07	.22	1.88	250	5
HL21-2-5	2/0 STR – 4/0 STR	3/8	1.00	9/16	3.00	1.00	1.33	.25	1.75	250	5
HL30-2-2	4/0 STR – 300 kcmil	3/8	1.00	5/8	3.13	1.06	1.45	.31	2.00	350	2
HL50-2-2	300 kcmil – 500 kcmil	3/8	1.00	3/4	3.44	1.38	1.66	.34	2.00	480	2

**Uses slotted head set screw.

Technical Info

Index



Two-Hole, Straight Tongue Lug with NEMA Hole Sizes and Spacing

For Use with Copper Code Conductors

Type HL-2N

- Cast from high strength corrosion resistant copper alloy to provide premium electrical and mechanical performance
- Wire range-taking capability minimizes inventory requirements
- Internal pressure plate provides uniform clamping force on conductor for premium electrical performance
- Internal barrel serrations allow for premium wire pull-out strength
- Inspection window to visually assure full conductor insertion
- Flat bottom allows for complete contact with mounting surface
- UL Listed for use up to 600V and temperature rated 90°C

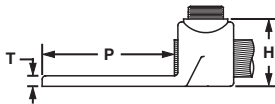
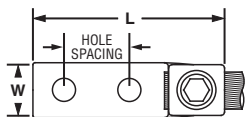

Part Number	Copper Conductor Size Range	Stud Hole Size (In.)	Stud Hole Spacing (In.)	Hex Key Size (In.)	Figure Dimensions (In.)					Tightening Torque (In.-Lbs.)	Std. Pkg. Qty.
					L	W	H	T	P		
◆ HL8-2N-X	#4 SOL – #1 STR	1/2	1.75	7/16	3.94	1.00	.90	.22	3.00	100	10
◆ HL13-2N-5	#1 STR – 2/0 STR	1/2	1.75	9/16	4.25	1.00	1.07	.22	3.00	250	5
◆ HL21-2N-5	2/0 STR – 4/0 STR	1/2	1.75	9/16	4.19	1.25	1.34	.25	3.00	250	5
◆ HL30-2N-2	4/0 STR – 300 kcmil	1/2	1.75	5/8	4.25	1.25	1.46	.31	3.00	350	2

◆NEMA hole sizes and spacing.



Two-Hole, Straight Tongue, Tandem Set Screw Lug

For Use with Copper Code Conductors

Type HHL-2N

- Cast from high strength corrosion resistant copper alloy to provide premium electrical and mechanical performance
- Double set screws provide additional wire secureness for use in heavy duty applications
- Wire range-taking capability minimizes inventory requirements
- Internal pressure plate provides uniform clamping force on conductor for premium electrical performance
- Internal barrel serrations allow for premium wire pull-out strength
- Inspection window to visually assure full conductor insertion
- Flat bottom allows for complete contact with mounting surface
- UL Listed for use up to 600V and temperature rated 90°C

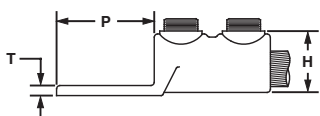
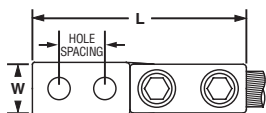

Part Number	Copper Conductor Size Range	Stud Hole Size (In.)	Stud Hole Spacing (In.)	Hex Key Size (In.)	Figure Dimensions (In.)					Tightening Torque (In.-Lbs.)	Std. Pkg. Qty.
					L	W	H	T	P		
◆ HHL8-2N-X	#4 SOL – #1 STR	1/2	1.75	7/16	5.13	1.00	.80	.22	3.00	100	10
◆ HHL13-2N-5	#1 STR – 2/0 STR	1/2	1.75	9/16	4.88	1.25	1.00	.22	3.00	250	5
◆ HHL21-2N-5	2/0 STR – 4/0 STR	1/2	1.75	9/16	5.63	1.50	1.37	.25	3.00	250	5
◆ HHL30-2N-1	4/0 STR – 300 kcmil	1/2	1.75	5/8	5.88	1.50	1.45	.31	3.00	350	1

◆NEMA hole sizes and spacing.

System Overview

Terminals

Disconnects

Splices

Ferrules

Compression Connectors

Crimping Tools

Mechanical Connectors

Grounding Connectors

Support Products

Technical Info

Index

System Overview



Two-Hole, Straight Tongue, Two Barrel Lug

For Use with Copper Code Conductors

Type H2L-2N

Terminals

- Allows for termination of two copper conductors
- Cast from high strength corrosion resistant copper alloy to provide premium electrical and mechanical performance
- Wire range-taking capability minimizes inventory requirements
- Internal pressure plate provides uniform clamping force on conductor for premium electrical performance
- Internal barrel serrations provide premium wire pull-out strength
- Inspection window to visually assure full conductor insertion
- Flat bottom allows for complete contact with mounting surface
- UL Listed for use up to 600V and temperature rated 90°C

Disconnects



Splices

Ferrules

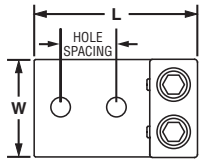

Compression Connectors

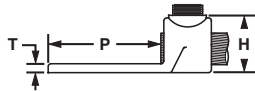

Part Number	Copper Conductor Size Range	Stud Hole Size (In.)	Stud Hole Spacing (In.)	Hex Key Size (In.)	Figure Dimensions (In.)					Tightening Torque (In.-Lbs.)	Std. Pkg. Qty.
					L	W	H	T	P		
◆ H2L4-2N-X	#8 SOL – #4 STR	1/2	1.75	**	3.75	1.25	.76	.19	3.00	35	10
◆ H2L8-2N-2	#4 SOL – #1 STR	1/2	1.75	7/16	3.94	1.38	.92	.22	3.00	100	2
◆ H2L13-2N-2	#1 STR – 2/0 STR	1/2	1.75	9/16	4.00	1.63	1.06	.22	3.00	250	2
◆ H2L21-2N-2	2/0 STR – 4/0 STR	1/2	1.75	9/16	4.19	1.88	1.34	.31	3.00	250	2
◆ H2L30-2N-1	4/0 STR – 300 kcmil	1/2	1.75	5/8	4.38	2.00	1.45	.31	3.00	350	1

**Uses slotted head set screw.
◆NEMA hole sizes and spacing.

Crimping Tools



Two-Hole, Straight Tongue, Two Barrel, Tin Plated Lug

For Use with Copper Code Conductors

Type P2NLT

Mechanical Connectors

- Allows for termination of two copper conductors
- Cast from high strength corrosion resistant copper alloy to provide premium electrical and mechanical performance
- Tin plated to inhibit corrosion
- Wire range-taking capability minimizes inventory requirements
- Internal barrel serrations provide premium wire pull-out strength
- Inspection window to visually assure full conductor insertion
- Plated steel set screw provides high strength, durable electrical contact
- Flat bottom allows for complete contact with mounting surface
- UL Listed for use up to 600V and temperature rated 90°C

Grounding Connectors



Support Products

Part Number	Copper Conductor Size Range	Stud Hole Size (In.)	Stud Hole Spacing (In.)	Hex Key Size (In.)	Figure Dimensions (In.)					Tightening Torque (In.-Lbs.)	Std. Pkg. Qty.
					L	W	H	T	P		
◆ P2NLT-500-3	#4 SOL – 500 kcmil	1/2	1.75	3/8	4.50	2.50	1.47	.38	3.00	375	3

◆NEMA hole sizes and spacing.

Technical Info

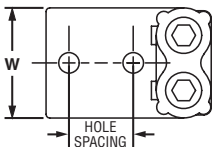

Index

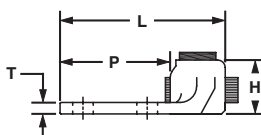

Two Set Screw Splice

For Use with Copper Code Conductors

Type PNLC

- Cast from high strength corrosion resistant copper alloy to provide premium electrical and mechanical performance
- Wire range-taking capability minimizes inventory requirements
- Plated steel set screw provides high strength, durable electrical contact between conductor and connector
- Internal wire stops to prevent over-insertion of conductor
- For use up to 600V and temperature rated 90°C

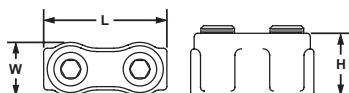

Part Number	Copper Conductor Size Range	Hex Key Size (In.)	Figure Dimensions (In.)			Tightening Torque (In.-Lbs.)	Std. Pkg. Qty.
			L	W	H		
PNLC-1/0-3	#8 SOL – 1/0 STR	1/4	1.63	.72	.84	200	3
PNLC-250-1	#6 SOL – 250 kcmil	3/8	2.13	.97	1.06	375	1
PNLC-500-1	#4 SOL – 500 kcmil	3/8	3.00	1.38	1.47	375	1

Two Set Screw Splice with Internal Pressure Plate

For Use with Copper Code Conductors

Type HC

- Cast from high strength corrosion resistant copper alloy to provide premium electrical and mechanical performance
- Wire range-taking capability minimizes inventory requirements
- Internal pressure plate provides uniform clamping force on conductor for premium electrical performance
- Internal barrel serrations provide premium wire pull-out strength
- Internal wire stops to prevent over-insertion of conductor
- UL Listed for use up to 600V and temperature rated 90°C

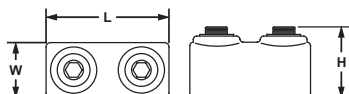

Part Number	Copper Conductor Size Range	Hex Key Size (In.)	Figure Dimensions (In)			Tightening Torque (In.-Lbs.)	Std. Pkg. Qty.
			L	W	H		
HC4-3*	#8 SOL – #4 STR	**	1.25	.50	.56	35	3
HC8-3*	#4 SOL – #1 STR	7/16	1.75	.69	.81	100	3
HC13-3	#1 STR – 2/0 STR	9/16	2.00	.81	.94	250	3
HC21-1	2/0 STR – 4/0 STR	9/16	2.25	1.00	1.19	250	1
HC30-1	4/0 STR – 300 kcmil	5/8	2.56	1.19	1.44	350	1
HC50-1	300 kcmil – 500 kcmil	3/4	3.00	1.38	1.63	480	1

* Includes swivel screws, not internal pressure plate.

** Uses slotted head set screw.

System Overview

Terminals

Disconnects

Splices

Ferrules

Compression Connectors

Crimping Tools

Mechanical Connectors

Grounding Connectors

Support Products

Technical Info

Index

System Overview



One-Hole, Straight Fixed Tongue Lug

For Use with Stranded Copper Code Conductors

Type CX

Terminals

- Made from high strength electrolytic copper to provide premium electrical and mechanical performance
- Compact design saves space
- Wire range-taking capability minimizes inventory requirements
- Inspection window to visually assure full conductor insertion
- Plated steel set screw provides high strength, durable electrical contact between conductor and connector
- UL Listed and CSA Certified for use up to 600V

Disconnects

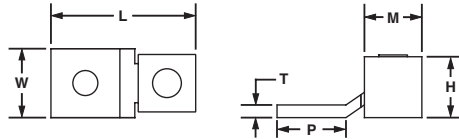

Splices

Ferrules

Part Number	Copper Conductor Size Range	Current Rating (Amps)	Stud Hole Size (In.)	Hex Size (In.)	Figure Dimensions (In.)						Tightening Torque (In.-Lbs.)	Std. Pkg. Qty.
					L	W	H	T	P	M		
CX35-36-C	#14 AWG – #6 AWG	35	3/16	**	1.02	.38	.48	.07	.44	.38	25	100
CX70-14-C	#14 AWG – #4 AWG, (2) #14 AWG, (2) #12 AWG	70	1/4	**	1.27	.50	.57	.08	.59	.50	35	100
CX125-14-Q	#4 AWG – 1/0 AWG	125	1/4	**	1.53	.62	.77	.13	.84	.62	50	25
CX225-56-Q	#2 AWG – 4/0 AWG	225	5/16	9/16	2.19	1.00	1.13	.13	1.06	1.00	50	25
CX400-38-3	4/0 AWG – 500 kcmil	400	3/8	3/4	3.16	1.50	1.65	.19	1.69	1.38	50	3

**Uses slotted head set screw.

Crimping Tools



One-Hole, Straight Fixed Tongue, Tin Plated Lug

For Use with Stranded Copper Code Conductors

Type CX-T

Mechanical Connectors

- Made from high strength electrolytic copper to provide premium electrical and mechanical performance
- Tin plated to inhibit corrosion
- Compact design saves space
- Wire range-taking capability minimizes inventory requirements
- Inspection window to visually assure full conductor insertion
- Plated steel set screw provides high strength, durable electrical contact between conductor and connector
- UL Listed and CSA Certified for use up to 600V

Grounding Connectors

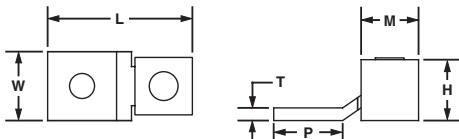

Support Products

Technical Info

Part Number	Copper Conductor Size Range	Current Rating (Amps)	Stud Hole Size (In.)	Hex Size (In.)	Figure Dimensions (In.)						Tightening Torque (In.-Lbs.)	Std. Pkg. Qty.
					L	W	H	T	P	M		
CX35-36T-C	#14 AWG – #6 AWG	35	3/16	**	1.02	.38	.48	.07	.44	.38	25	100
CX70-14T-C	#14 AWG – #4 AWG, (2) #14 AWG, (2) #12 AWG	70	1/4	**	1.27	.50	.57	.08	.59	.50	35	100
CX125-56T-Q	#4 AWG – 1/0 AWG	125	5/16	**	1.53	.62	.77	.13	.84	.62	50	25
CX225-38T-Q	#2 AWG – 4/0 AWG	225	3/8	9/16	2.19	1.00	1.13	.13	1.06	1.00	50	25
CX400-12T-3	4/0 AWG – 500 kcmil	400	1/2	3/4	3.16	1.50	1.65	.19	1.69	1.38	50	3

**Uses slotted head set screw.



One-Hole, Straight Floating Tongue Lug

For Use with Stranded Copper Code Conductors

Type CS

- Made from high strength electrolytic copper to provide premium electrical and mechanical performance
- Wire range-taking capability minimizes inventory requirements
- Internal pressure bar and V-bottom collar provide uniform clamping force on conductor to assure positive contact between conductor and connector
- Inspection window to visually assure full conductor insertion
- Plated steel set screw provides high strength, durable electrical contact between conductor and connector
- UL Listed and CSA Certified for use up to 600V

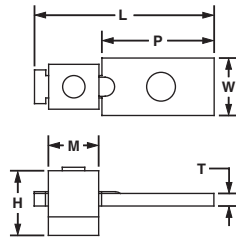

Part Number	Copper Conductor Size Range	Current Rating (Amps)	Stud Hole Size (In.)	Hex Size (In.)	Figure Dimensions (In.)						Tightening Torque (In.-Lbs.)	Std. Pkg. Qty.
					L	W	H	T	P	M		
CS25-18-C	#14 AWG – #10 AWG	25	1/8	**	1.16	.32	.37	.07	.75	.28	45	100
CS35-36-C	#14 AWG – #6 AWG, (2) #10 AWG, (2) #12 AWG, (2) #14 AWG, (1) #10 AWG with (1) #12 AWG, (1) #12 AWG with (1) #14 AWG	50	3/16	**	1.14	.38	.52	.07	.60	.44	120	100
CSA70-14-C	#14 AWG – #4 AWG	70	1/4	**	1.30	.50	.56	.08	.71	.42	200	100
CS70-14-C	#12 AWG – #1 AWG, (1) #8 AWG with (1) #4 AWG, (1) #8 AWG with (1) #6 AWG	90	1/4	**	1.50	.50	.65	.08	.81	.50	200	100
CS125-14-Q	#2 AWG – 1/0 AWG	125	1/4	**	1.94	.62	.88	.13	1.00	.62	200	25
CS175-38-Q	#4 AWG – 3/0 AWG	175	3/8	9/16	2.19	.75	1.04	.16	1.25	.75	375	25
CS225-56-Q	#6 AWG – 4/0 AWG	225	5/16	5/8	2.38	1.00	1.13	.13	1.19	1.00	275	25
CS300-38-Q	#1 AWG – 350 kcmil	300	3/8	3/4	3.19	1.00	1.38	.19	1.63	1.23	375	25
CS400-38-3	1/0 AWG – 500 kcmil	400	3/8	3/4	3.88	1.50	1.56	.19	2.19	1.50	375	3
CS650-12-3	600 kcmil – 1000 kcmil	650	1/2	1 1/8	5.13	2.00	2.34	.25	2.82	1.87	500	3

**Uses slotted head set screw.

System Overview

Terminals

Disconnects

Splices

Ferrules

Compression Connectors

Crimping Tools

Mechanical Connectors

Grounding Connectors

Support Products

Technical Info

Index

System Overview



Two-Hole, Straight Floating Tongue Lug

For Use with Stranded Copper Code Conductors

Type CD

Terminals

- Made from high strength electrolytic copper to provide premium electrical and mechanical performance
- Wire range-taking capability minimizes inventory requirements
- Internal pressure bar and V-bottom collar provide uniform clamping force on conductor to assure positive contact between conductor and connector
- Inspection window to visually assure full conductor insertion
- Plated steel set screw provides high strength, durable electrical contact between conductor and connector
- UL Listed and CSA Certified for use up to 600V
- Available with NEMA hole sizes and spacing

Disconnects

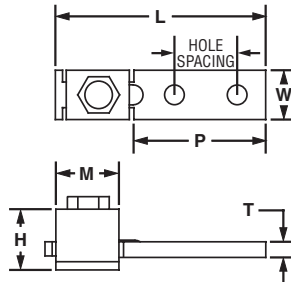

Splices

Ferrules

Compression Connectors

Crimping Tools

Part Number	Copper Conductor Size Range	Current Rating (Amps)	Stud Hole Size (In.)	Stud Hole Spacing (In.)	Hex Size (In.)	Figure Dimensions (In.)						Tightening Torque (In.-Lbs.)	Std. Pkg. Qty.
						L	W	H	T	P	M		
CD35-36-Q	#14 AWG – #6 AWG, (2) #10 AWG, (2) #12 AWG, (2) #14 AWG, (1) #10 AWG with (1) #12 AWG, (1) #12 AWG with (1) #14 AWG	50	3/16	1.00	**	2.13	.38	.52	.07	1.60	.44	120	25
CD70-14-Q	#12 AWG – #1 AWG	90	1/4	1.00	**	2.26	.50	.65	.09	1.63	.50	200	25
CD125-14-Q	#2 AWG – 1/0 AWG	125	1/4	1.00	**	2.94	.62	.88	.13	1.88	.62	200	25
CD225-56-Q	#6 AWG – 4/0 AWG	225	5/16	1.00	5/8	3.38	1.00	1.17	.13	2.13	1.00	275	25
CD300-38-3	#1 AWG – 350 kcmil	300	3/8	1.00	3/4	4.94	1.00	1.39	.19	3.32	1.23	375	3
CD400-38-3	1/0 AWG – 500 kcmil	400	3/8	1.75	3/4	5.62	1.50	1.56	.19	3.57	1.50	375	3
CD650-12-3	600 kcmil – 1000 kcmil	650	1/2	1.75	1 1/8	6.88	2.00	2.34	.25	4.69	1.88	500	3

**Uses slotted head set screw.

◆NEMA hole sizes and spacing.

Mechanical Connectors

Grounding Connectors

Support Products

Technical Info

Index



One-Hole, Offset Floating Tongue Lug

For Use with Stranded Copper Code Conductors

Type CB

- Made from high strength electrolytic copper to provide premium electrical and mechanical performance
- Wire range-taking capability minimizes inventory requirements
- Internal pressure bar and V-bottom collar provide uniform clamping force on conductor to assure positive contact between conductor and connector
- Inspection window to visually assure full conductor insertion
- Plated steel set screw provides high strength, durable electrical contact between conductor and connector
- UL Listed and CSA Certified for use up to 600V

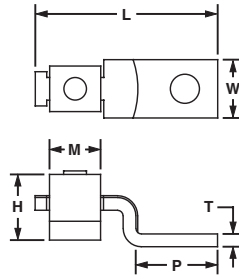
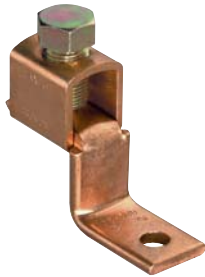

Part Number	Copper Conductor Size Range	Current Rating (Amps)	Stud Hole Size (In.)	Hex Size (In.)	Figure Dimensions (In.)						Tightening Torque (In.-Lbs.)	Std. Pkg. Qty.
					L	W	H	T	P	M		
CB25-18-C	#14 AWG – #10 AWG	25	1/8	**	1.00	.32	.37	.07	.44	.28	45	100
CB35-36-C	#14 AWG – #6 AWG, (2) #10 AWG, (2) #12 AWG, (2) #14 AWG, (1) #10 AWG with (1) #12 AWG, (1) #12 AWG with (1) #14 AWG	50	3/16	**	1.19	.38	.52	.07	.47	.44	120	100
CBA70-14-C	#14 AWG – #4 AWG	70	1/4	**	1.31	.50	.58	.08	.57	.43	200	100
CB70-14-C	#12 AWG – #1 AWG, (1) #8 AWG with (1) #4 AWG, (1) #8 AWG with (1) #6 AWG	90	1/4	**	1.55	.50	.65	.09	.66	.49	200	100
CB125-14-Q	#2 AWG – 1/0 AWG	125	1/4	**	1.97	.63	.88	.13	.93	.62	200	25
CB175-38-Q	#4 AWG – 3/0 AWG	175	3/8	5/16	2.19	.75	1.04	.16	.94	.74	375	25
CB225-56-Q	#6 AWG – 4/0 AWG	225	5/16	5/8	2.38	1.00	1.17	.13	1.06	1.00	275	25
CB300-38-Q	#1 AWG – 350 kcmil	300	3/8	3/4	3.16	1.00	1.41	.19	1.50	1.23	375	25
CB400-38-3	1/0 AWG – 500 kcmil	400	3/8	3/4	4.25	1.50	1.57	.19	2.02	1.50	375	3
CB650-12-3	600 kcmil – 1000 kcmil	650	1/2	1 1/8	4.63	2.00	2.34	.25	2.04	1.84	500	3

**Uses slotted head set screw.

System Overview

Terminals

Disconnects

Splices

Ferrules

Compression Connectors

Crimping Tools

Mechanical Connectors

Grounding Connectors

Support Products

Technical Info

Index

System Overview



One-Hole, Offset Floating Tongue, Two Barrel Lug

For Use with Stranded Copper Code Conductors

Type DC

- Dual barrel provides termination of two copper conductors
- Made from high strength electrolytic copper to provide premium electrical and mechanical performance
- Wire range-taking capability minimizes inventory requirements
- Internal pressure bar and V-bottom collar provide uniform clamping force on conductor to assure positive contact between conductor and connector
- Inspection window to visually assure full conductor insertion
- Plated steel set screw provides high strength, durable electrical contact between conductor and connector
- UL Listed and CSA Certified for use up to 600V

Terminals

Disconnects

Splices

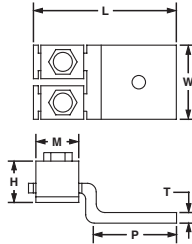

Ferrules

Part Number	Copper Conductor Size Range	Current Rating (Amps)	Stud Hole Size (In.)	Hex Size (In.)	Figure Dimensions (In.)						Tightening Torque (In.-Lbs.)	Std. Pkg. Qty.
					L	W	H	T	P	M		
DC450-38-3	#6 AWG – 4/0 AWG	450	3/8	5/8	3.40	1.50	1.13	.19	1.94	1.00	375	3
DC600-38-3	#1 AWG – 350 kcmil	600	3/8	3/4	3.50	1.75	1.39	.19	1.76	1.23	375	3
DC800-12-3	1/0 AWG – 500 kcmil	800	1/2	3/4	4.43	2.00	1.13	.25	2.09	1.50	500	3

Compression Connectors



Two-Hole, Offset Floating Tongue Lug

For Use with Stranded Copper Code Conductors

Type CO

- Made from high strength electrolytic copper to provide premium electrical and mechanical performance
- Wire range-taking capability minimizes inventory requirements
- Internal pressure bar and V-bottom collar provide uniform clamping force on conductor to assure positive contact between conductor and connector
- Inspection window to visually assure full conductor insertion
- Plated steel set screw provides high strength, durable electrical contact between conductor and connector
- UL Listed and CSA Certified for use up to 600V
- Available with NEMA hole sizes and spacing

Crimping Tools

Mechanical Connectors

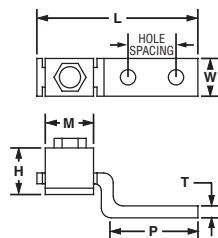

Grounding Connectors

Support Products

Part Number	Copper Conductor Size Range	Current Rating (Amps)	Stud Hole Size (In.)	Stud Hole Spacing (In.)	Hex Size (In.)	Figure Dimensions (In.)						Tightening Torque (In.-Lbs.)	Std. Pkg. Qty.
						L	W	H	T	P	M		
CO35-36-Q	#14 AWG – #6 AWG, (2) #10 AWG, (2) #12 AWG, (2) #14 AWG, (1) #10 AWG with (1) #12 AWG, (1) #12 AWG with (1) #14 AWG	50	3/16	1.00	**	2.19	.38	.52	.07	1.50	.44	120	25
CO70-14-Q	#12 AWG – #1 AWG, (1) #8 AWG with (1) #4 AWG, (1) #8 AWG with (1) #6 AWG	90	1/4	1.00	**	2.50	.50	.65	.09	1.66	.50	200	25
CO125-14-Q	#2 AWG – 1/0 AWG	125	1/4	1.00	**	2.97	.63	.88	.13	1.88	.63	200	25
CO225-56-Q	#6 AWG – 4/0 AWG	225	5/16	1.00	5/8	3.62	1.00	1.12	.13	2.27	1.00	275	25
CO300-38-3	#1 AWG – 350 kcmil	300	3/8	1.87	3/4	5.69	1.00	1.39	.19	4.01	1.23	375	3
CO400-38-3	1/0 AWG – 500 kcmil	400	3/8	1.75	3/4	6.00	1.50	1.56	.19	3.77	1.53	375	3
◆ CO650-12-3	600 kcmil – 1000 kcmil	650	1/2	1.75	1 1/8	6.25	2.00	2.34	.25	3.69	1.88	500	3

**Uses slotted head set screw.
◆NEMA holes sizes and spacing.



One-Hole, Single Barrel Lug

For Use with Stranded Aluminum or Copper Code Conductors

Type LAMA

- Made from high strength, extruded aluminum alloy to provide premium electrical and mechanical performance
- Tin plated to inhibit corrosion
- Compact design saves space
- Wire range-taking capability minimizes inventory requirements
- Inspection window to visually assure full conductor insertion
- Plated steel or aluminum set screw provides high strength, durable electrical contact between conductor and connector
- UL Listed and CSA Certified for use up to 600V and UL temperature rated 90°C

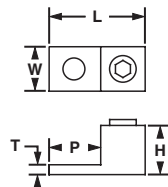
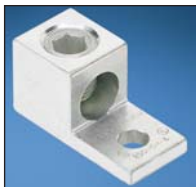

Part Number	Conductor Size Range	Stud Hole Size (In.)	Hex Key Size (In.)	Figure Dimensions (In.)					Tightening Torque (In.-Lbs.)	Std. Pkg. Qty.
				L	W	H	T	P		
LAMA6-14-Q	#14 AWG – #6 AWG	1/4	**	1.06	.38	.50	.09	.69	45*	25
LAMA2-14-Q	#14 AWG – #2 AWG	1/4	**	1.16	.50	.56	.09	.69	50*	25
LAMA1/0-14-Q	#14 AWG – 1/0 AWG	1/4	**	1.47	.62	.81	.19	.85	50*	25
LAMA2/0-14-Q	#14 AWG – 2/0 AWG	1/4	**	1.47	.62	.81	.19	.85	50*	25
LAMA250-56-Q	#6 AWG – 250 kcmil	5/16	3/8	2.00	.90	1.06	.22	1.00	375*	25
LAMA300-56-Q	#6 AWG – 300 kcmil	5/16	3/8	2.00	.90	1.06	.22	1.00	375*	25
LAMA350-38-Q	#6 AWG – 350 kcmil	3/8	3/8	2.25	1.13	1.25	.25	1.13	375*	25
LAMA500-38-6	#4 AWG – 500 kcmil	3/8	1/2	2.75	1.38	1.50	.31	1.50	500	6
LAMA600-38-6	#4 AWG – 600 kcmil	3/8	1/2	2.75	1.38	1.50	.31	1.50	500	6
LAMA600S-38-6***	#4 AWG – 600 kcmil or (2) 1/0 AWG – 250 kcmil	3/8	1/2	2.81	1.38	1.81	.31	1.50	500	6
LAMA800-58-6	350 kcmil – 800 kcmil	5/8	9/16	3.38	1.63	1.94	.38	1.75	600	6
LAMA1000-58-6	500 kcmil – 1000 kcmil	5/8	9/16	3.50	1.75	2.13	.44	1.75	600	6

The use of PANDUIT® oxide inhibiting joint compound (CMP-100) is recommended for pad to pad and conductor connections. See [pages H33, F118](#).

*Listed torque values are for maximum conductor sizes, consult the installation instruction sheet for smaller sizes.

Uses slotted head set screw. *Accommodates two conductors for conductor range 1/0 AWG – 250 kcmil.



Two-Hole, Single Barrel Lug

For Use with Stranded Aluminum or Copper Code Conductors

Type LAMB

- Made from high strength, extruded aluminum alloy to provide premium electrical and mechanical performance
- Tin plated to inhibit corrosion
- Compact design saves space
- Wire range-taking capability minimizes inventory requirements
- Inspection window to visually assure full conductor insertion
- Plated steel or aluminum set screw provides high strength, durable electrical contact between conductor and connector
- LAMB provided with dual set screws for premium clamping of conductor to connector for heavy duty applications
- UL Listed and CSA Certified for use up to 600V and UL temperature rated 90°C

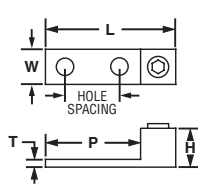

Figure 1

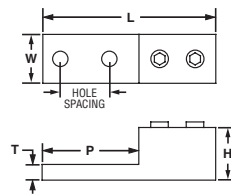

Figure 2

Part Number	Figure No.	Conductor Size Range	Stud Hole Size (In.)	Stud Hole Spacing (In.)	Hex Key Size (In.)	Figure Dimensions (In.)					Tightening Torque (In.-Lbs.)	Std. Pkg. Qty.
						L	W	H	T	P		
◆ LAMB350-12-6	1	#6 AWG – 350 kcmil	1/2	1.75	3/8	4.19	1.13	1.25	.25	3.06	#6 – #2 AWG — 200, #1 AWG – 350 kcmil — 375	6
◆ LAMB600-12-3	1	#4 AWG – 600 kcmil	1/2	1.75	1/2	4.69	1.50	1.56	.44	3.31	500	3
◆ LAMLB800-12-3	2	350 kcmil – 800 kcmil	1/2	1.75	3/8	6.19	1.75	1.88	.56	3.44	375	3

The use of PANDUIT® oxide inhibiting joint compound (CMP-100) is recommended for pad to pad and conductor connections. See [pages H33, F118](#).

◆NEMA hole sizes and spacing.

System Overview



One-Hole, Two Barrel Lug

For Use with Stranded Aluminum or Copper Code Conductors

Type LAM2A

- Dual barrel provides termination of two conductors
- Made from high strength, extruded aluminum alloy to provide premium electrical and mechanical performance
- Tin plated to inhibit corrosion
- Wire range-taking capability minimizes inventory requirements
- Inspection window to visually assure full conductor insertion
- Plated steel or aluminum set screw provides high strength, durable electrical contact between conductor and connector
- UL Listed and CSA Certified for use up to 600V and UL temperature rated 90°C

Disconnects

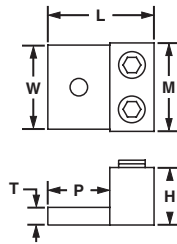

Splices

Ferrules

Part Number	Conductor Size Range	Stud Hole Size (In.)	Hex Key Size (In.)	Figure Dimensions (In.)						Tightening Torque (In.-Lbs.)	Std. Pkg. Qty.
				L	W	H	T	P	M		
LAM2A1/0-14-6	#14 AWG – 1/0 AWG	1/4	**	1.47	1.20	.81	.19	.85	1.12	45*	6
LAM2A2/0-14-6	#14 AWG – 2/0 AWG	1/4	**	1.47	1.20	.81	.19	.85	1.20	50*	6
LAM2A250-38-6	#6 AWG – 250 kcmil	3/8	3/8	2.56	1.50	1.19	.25	1.56	1.62	375	6
LAM2A350-12-6	#6 AWG – 350 kcmil	1/2	3/8	2.88	1.75	1.25	.25	1.75	1.94	375*	6
LAM2A600-12-6	#4 AWG – 600 kcmil	1/2	1/2	3.13	2.00	1.56	.44	1.75	2.38	500	6
LAM2A800-58-6	350 kcmil – 800 kcmil	5/8	7/16	3.50	2.81	1.69	.50	2.00	2.81	500	6
LAM2A1000-58-6	500 kcmil – 1000 kcmil	5/8	3/8	3.50	2.81	1.69	.50	2.00	2.87	500	6

The use of PANDUIT® oxide inhibiting joint compound (CMP-100) is recommended for pad to pad and conductor connections. See [pages H33, F118](#).

*Listed torque values are for maximum conductor sizes, consult the installation instruction sheet for smaller sizes.

**Uses slotted head set screw. ^Not CSA Certified. ▼Not UL Listed or CSA Certified.

Crimping Tools

Mechanical Connectors



One-Hole, Vertical Two Barrel Lug

For Use with Stranded Aluminum or Copper Code Conductors

Type LAM2SA

- Dual barrel provides termination of two conductors
- Made from high strength, extruded aluminum alloy to provide premium electrical and mechanical performance
- Tin plated to inhibit corrosion
- Wire range-taking capability minimizes inventory requirements
- Inspection window to visually assure full conductor insertion
- Plated steel or aluminum set screw provides high strength, durable electrical contact between conductor and connector
- UL Listed and CSA Certified for use up to 600V and UL temperature rated 90°C

Grounding Connectors

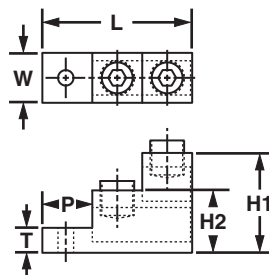

Support Products

Technical Info

Part Number	Conductor Size Range	Stud Hole Size (In.)	Hex Key Size (In.)	Figure Dimensions (In.)						Tightening Torque (In.-Lbs.)	Std. Pkg. Qty.
				L	W	H1	H2	T	P		
LAM2SA300-56-3	#6 AWG – 300 kcmil	5/16	5/16	3.00	1.00	2.00	1.25	.50	1.00	375*	3

The use of PANDUIT® oxide inhibiting joint compound (CMP-100) is recommended for pad to pad and conductor connections. See [pages H33, F118](#).

*Listed torque values are for maximum conductor sizes, consult the installation instruction sheet for smaller sizes.

Index



Two-Hole, Two Barrel Lug

For Use with Stranded Aluminum or Copper Code Conductors

Type LAM2B

- Dual barrel provides termination of two conductors
- Made from high strength, extruded aluminum alloy to provide premium electrical and mechanical performance
- Tin plated to inhibit corrosion
- Wire range-taking capability minimizes inventory requirements
- Inspection window to visually assure full conductor insertion

- Plated steel or aluminum set screw provides high strength, durable electrical contact between conductor and connector
- LAM2LB connector provided with dual set screws for premium clamping of conductor to connector for heavy duty applications
- UL Listed for use up to 600V and temperature rated 90°C

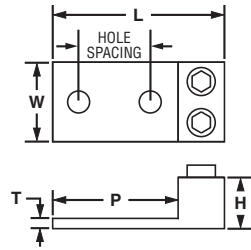

Figure 1

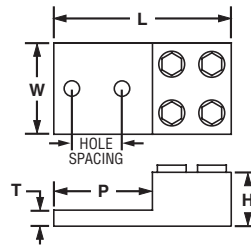

Figure 2

Part Number	Figure No.	Conductor Size Range	Stud Hole Size (In.)	Stud Hole Spacing (In.)	Hex Key Size (In.)	Figure Dimensions (In.)					Tightening Torque (In.-Lbs.)	Std. Pkg. Qty.
						L	W	H	T	P		
◆ LAM2B350-12-3	1	# 6 AWG – 350 kcmil	1/2	1.75	3/8	4.19	1.94	1.25	.25	3.06	375**	3
◆ LAM2B600-12-3	1	# 4 AWG – 600 kcmil	1/2	1.75	1/2	4.69	2.44	1.56	.44	3.31	500	3
◆ LAM2LB800-12-3*	2	350 kcmil – 800 kcmil	1/2	1.75	3/8	6.19	3.19	1.88	.56	3.44	500	3

The use of PANDUIT® oxide inhibiting joint compound (CMP-100) is recommended for pad to pad and conductor connections. See [pages H33, F118](#).

*Not UL Listed. **Listed torque values are for maximum conductor sizes, consult the installation instruction sheet for smaller sizes.

◆NEMA hole sizes and spacing.



Two-Hole, Vertical Two Barrel Lug

For Use with Stranded Aluminum or Copper Code Conductors

Type LAM2SB

- Dual barrel provides termination of two conductors
- Vertical configuration saves space
- Made from high strength, extruded aluminum alloy to provide premium electrical and mechanical performance
- Tin plated to inhibit corrosion
- Wire range-taking capability minimizes inventory requirements

- Inspection window to visually assure full conductor insertion
- Plated steel or aluminum set screw provides high strength, durable electrical contact between conductor and connector
- UL Listed and CSA Certified for use up to 600V and UL temperature rated 90°C

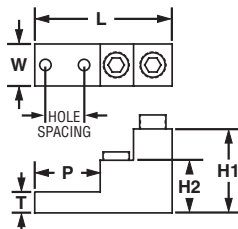

Figure 1

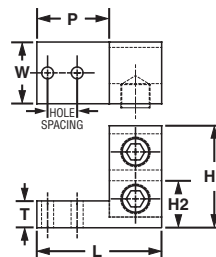

Figure 2

Part Number	Figure No.	Conductor Size Range	Stud Hole Size (In.)	Stud Hole Spacing (In.)	Hex Key Size (In.)	Figure Dimensions (In.)					Tightening Torque (In.-Lbs.)	Std. Pkg. Qty.	
						L	W	H1	H2	T			P
LAM2SB600-38-1*	1	#2 AWG – 600 kcmil	3/8	1.38	1/2	4.91	1.50	3.00	1.88	.75	2.34	500	1
LAM2SB750-38-1*	1	3/0 AWG – 750 kcmil	3/8	1.38	1/2	4.91	1.50	3.00	1.88	.75	2.34	500	1
LAM2SSB500-14-1	2	4/0 AWG – 500 kcmil	1/4	.69	3/8	2.91	1.44	2.38	1.77	.63	1.69	375	1

The use of PANDUIT® oxide inhibiting joint compound (CMP-100) is recommended for pad to pad and conductor connections. See [pages H33, F118](#).

*Not CSA Certified.

System Overview

Two-Hole, Three Barrel Lug

For Use with Stranded Aluminum or Copper Code Conductors

Type LAM3B

Terminals

- Triple barrel provides termination of three conductors
- Made from high strength, extruded aluminum alloy to provide premium electrical and mechanical performance
- Tin plated to inhibit corrosion
- Wire range-taking capability minimizes inventory requirements
- Inspection window to visually assure full conductor insertion
- Plated steel or aluminum set screw provides high strength, durable electrical contact between conductor and connector
- LAM3LB connector is provided with dual set screws to allow premium clamping of conductor to connector for heavy duty applications
- For use up to 600V and temperature rated 90°C
- Available with NEMA hole sizes and spacing

Disconnects



Splices

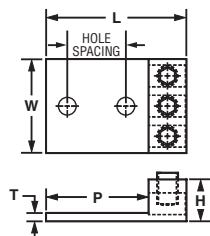

Figure 1

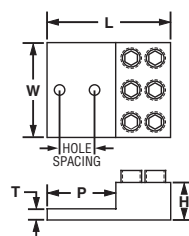

Figure 2

Ferrules

Part Number	Figure No.	Conductor Size Range	Stud Hole Size (In.)	Stud Hole Spacing (In.)	Hex Key Size (In.)	Figure Dimensions (In.)					Tightening Torque (In.-Lbs.)	Std. Pkg. Qty.
						L	W	H	T	P		
LAM3B2-14-6	1	#14 AWG – #2 AWG	5/16	.87	**	2.49	1.63	.47	.19	2.03	50*	6
LAM3B1/0-38-6	1	#12 AWG – 1/0 AWG	3/8	1.00	**	2.94	1.94	.63	.19	2.31	50*	6
◆ LAM3B3/0-12-3	1	#6 AWG – 3/0 AWG	1/2	1.75	1/4	4.19	2.81	.81	.25	3.38	200	3
◆ LAM3B250-12-1	1	#6 AWG – 250 kcmil	1/2	1.75	5/16	4.19	2.81	1.25	.25	3.06	375*	1
◆ LAM3B350-12-1	1	# 6 AWG – 350 kcmil	1/2	1.75	5/16	4.19	3.00	1.25	.25	3.06	375*	1
◆ LAM3B600-12-1	1	# 2 AWG – 600 kcmil	1/2	1.75	1/2	4.69	3.75	1.56	.44	3.31	375	1
◆ LAM3LB800-12-1	2	350 kcmil – 800 kcmil	1/2	1.75	3/8	6.19	4.25	1.88	.56	3.44	375	1
◆ LAM3LB1000-12-1	2	500 kcmil – 1000 kcmil	1/2	1.75	3/8	6.19	4.75	1.88	.56	3.44	375	1

The use of PANDUIT® oxide inhibiting joint compound (CMP-100) is recommended for pad to pad and conductor connections. See pages H33, F118.

*Listed torque values are for maximum conductor sizes, consult the installation instruction sheet for smaller sizes.

**Uses slotted head set screw. ◆NEMA hole sizes and spacing.

Compression Connectors

Crimping Tools

Mechanical Connectors

Two-Hole, Vertical Three Barrel Lug

For Use with Stranded Aluminum or Copper Code Conductors

Type LAM3SB

Grounding Connectors

- Triple barrel provides termination of three conductors
- Vertical configuration saves space
- Made from high strength, extruded aluminum alloy to provide premium electrical and mechanical performance
- Tin plated to inhibit corrosion
- Wire range-taking capability minimizes inventory requirements
- Inspection window to visually assure full conductor insertion
- Plated steel or aluminum set screw provides high strength, durable electrical contact between conductor and connector
- For use up to 600V and temperature rated 90°C

Support Products



Technical Info

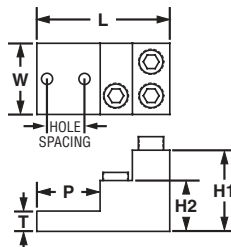

Index

Part Number	Conductor Size Range	Stud Hole Size (In.)	Stud Hole Spacing (In.)	Hex Key Size (In.)	Figure Dimensions (In.)						Tightening Torque (In.-Lbs.)	Std. Pkg. Qty.
					L	W	H1	H2	T	P		
LAM3SB600-38-1	#2 AWG – 600 kcmil	3/8	1.38	1/2	4.91	2.47	3.00	1.88	.75	2.34	500	1
LAM3SB750-38-1	3/0 AWG – 750kcmil	3/8	1.38	1/2	4.91	2.63	3.00	1.88	.75	2.34	500	1

The use of PANDUIT® oxide inhibiting joint compound (CMP-100) is recommended for pad to pad and conductor connections. See pages H33, F118.

Four-Hole, Three Barrel Lug

For Use with Stranded Aluminum or Copper Code Conductors

Type LAM3D

- Three barrels provide termination of three conductors
- Made from high strength, extruded aluminum alloy to provide premium electrical and mechanical performance
- Tin plated to inhibit corrosion
- Wire range-taking capability minimizes inventory requirements
- Inspection window to visually assure full conductor insertion
- Plated steel or aluminum set screw provides high strength, durable electrical contact between conductor and connector
- LAM3LD connector is provided with dual set screws to allow premium clamping of conductor to connector for heavy duty applications
- For use up to 600V and temperature rated 90°C

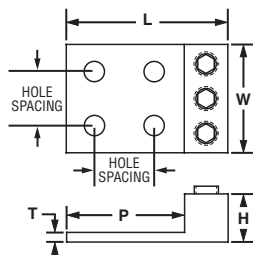

Figure 1

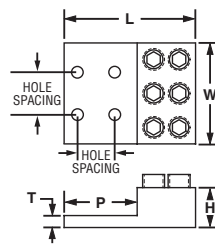

Figure 2

Part Number	Figure No.	Conductor Size Range	Stud Hole Size (In.)	Stud Hole Spacing (In.)	Hex Key Size (In.)	Figure Dimensions (In.)					Tightening Torque (In.-Lbs.)	Std. Pkg. Qty.
						L	W	H	T	P		
◆ LAM3D3/0-12-3	1	#6 AWG – 3/0 AWG	1/2	1.75	1/4	4.19	2.81	.81	.25	3.38	200	3
◆ LAM3D250-12-1	1	#6 AWG – 250 kcmil	1/2	1.75	1/4	4.19	2.81	1.25	.25	3.07	375*	1
◆ LAM3D350-12-1	1	#6 AWG – 350 kcmil	1/2	1.75	5/16	4.19	3.00	1.25	.25	3.06	375*	1
◆ LAM3D600-12-1	1	#2 AWG – 600 kcmil	1/2	1.75	3/8	4.69	3.75	1.56	.44	3.31	500	1
◆ LAM3LD800-12-1	2	350 kcmil – 800 kcmil	1/2	1.75	3/8	6.19	4.25	1.88	.56	3.44	375	1
◆ LAM3LD1000-12-1	2	500 kcmil – 1000 kcmil	1/2	1.75	9/16	6.19	4.75	1.88	.56	3.44	600	1

The use of PANDUIT® oxide inhibiting joint compound (CMP-100) is recommended for pad to pad and conductor connections. See [pages H33, F118](#).

*Listed torque values are for maximum conductor sizes, consult the installation instruction sheet for smaller sizes.

**Uses slotted head set screw. ◆NEMA hole sizes and spacing.



Two-Hole, Vertical Four Barrel Lug

For Use with Stranded Aluminum or Copper Code Conductors

Type LAM4SB

- Triple barrel provides termination of three conductors
- Vertical configuration saves space
- Made from high strength, extruded aluminum alloy to provide premium electrical and mechanical performance
- Tin plated to inhibit corrosion
- Wire range-taking capability minimizes inventory requirements
- Inspection window to visually assure full conductor insertion
- Plated steel or aluminum set screw provides high strength, durable electrical contact between conductor and connector
- For use up to 600V and temperature rated 90°C

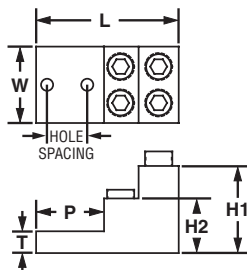

Part Number	Conductor Size Range	Stud Hole Size (In.)	Stud Hole Spacing (In.)	Hex Key Size (In.)	Figure Dimensions (In.)						Tightening Torque (In.-Lbs.)	Std. Pkg. Qty.
					L	W	H1	H2	T	P		
LAM4SB600-38-1	#2 AWG – 600 kcmil	3/8	1.38	1/2	4.91	2.47	3.00	1.88	.75	2.34	500	1
LAM4SB750-38-1	1/0 AWG – 750 kcmil	3/8	1.38	1/2	4.91	2.63	3.00	1.88	.75	2.34	500	1

The use of PANDUIT® oxide inhibiting joint compound (CMP-100) is recommended for pad to pad and conductor connections. See [pages H33, F118](#).

System Overview

Four-Hole, Four Barrel Lug

For Use with Stranded Aluminum or Copper Code Conductors

Type LAM4D

Terminals

- Four barrels provide termination of four conductors
- Made from high strength, extruded aluminum alloy to provide premium electrical and mechanical performance
- Tin plated to inhibit corrosion
- Wire range-taking capability minimizes inventory requirements
- Inspection window to visually assure full conductor insertion
- Plated steel or aluminum set screw provides high strength, durable electrical contact between conductor and connector
- LAM4LD connector is provided with dual set screws to allow premium clamping of conductor to connector for heavy duty applications
- For use up to 600V and temperature rated 90°C

Disconnects



Splices

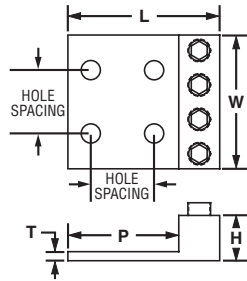

Figure 1

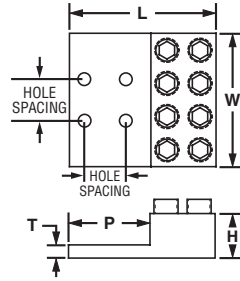

Figure 2

Ferrules

Compression Connectors

Part Number	Figure No.	Conductor Size Range	Stud Hole Size (In.)	Stud Hole Spacing (In.)	Hex Key Size (In.)	Figure Dimensions (In.)					Tightening Torque (In.-Lbs.)	Std. Pkg. Qty.
						L	W	H	T	P		
◆ LAM4D250-12-1	1	# 6 AWG – 250 kcmil	1/2	1.75	3/8	4.19	3.69	1.00	.25	3.06	375*	1
◆ LAM4D350-12-1	1	# 6 AWG – 350 kcmil	1/2	1.75	5/16	4.19	3.94	1.25	.25	3.06	275	1
◆ LAM4D600-12-1	1	# 2 AWG – 600 kcmil	1/2	1.75	3/8	4.69	5.00	1.56	.44	3.31	500	1
◆ LAM4LD800-12-1	2	350 kcmil – 800 kcmil	1/2	1.75	3/8	6.19	5.63	1.88	.56	3.44	375	1

Crimping Tools

The use of PANDUIT® oxide inhibiting joint compound (CMP-100) is recommended for pad to pad and conductor connections. See [pages H33, F118](#).

*Listed torque values are for maximum conductor sizes, consult the installation instruction sheet for smaller sizes.

◆NEMA hole sizes and spacing.

Mechanical Connectors

Grounding Connectors

Support Products

Technical Info

Index

Transformer Lug Kit

For Use with Stranded Aluminum or Copper Code Conductors

Type KLM



- Kits include all of the connectors and hardware to make a complete transformer connection in a single convenient package
- Lugs are made from high strength, extruded aluminum alloy and are tin plated to inhibit corrosion and oxidation
- Plated steel cap screws, Belleville and flat washers and hex nuts are provided to assure that terminal to bus connections are made using proper hardware resulting in true torque to pressure performance
- Hardware is packaged in a sealed plastic bag to prevent lost hardware prior to installation
- KLM6-800 and KLM350-800 kits include lugs that accommodate 750 kcmil conductors used with large transformers
- Lugs are UL Listed and CSA Certified for use up to 600V and UL temperature rated 90°C

Part Number	Transformer KVA Rating	Aluminum Mechanical Lug		Copper & Aluminum Conductor Size Range	Hardware (Sizes in Inches)					
		Part No.	Qty.		Hex Bolt Size	Qty.	Nut Size	Qty.	Washer Size	Qty.
KLM14-250	15 – 37.5 KVA 1PH 15 – 45 KVA 3PH	LAMA2-14	8	#14 AWG – #2 AWG #6 AWG – 250 kcmil	1/4 – 20 x 3/4 HH	8	1/4 – 20 HN	8	1/4 FLAT	16
		LAMA250-56	4					1/4 CMP	8	
KLM6-250	50 – 75 KVA 1 PH 75 – 112.5 KVA 3 PH	LAMA250-56	12	#6 AWG – 250 kcmil	1/4 – 20 x 3/4 HH	8	1/4 – 20 HN	16	1/4 FLAT	32
					1/4 – 20 x 2 HH	8			1/4 CMP	16
KLM6-600	100 – 167 KVA 1PH 150 – 300 KVA 3 PH	LAMA250-56	3	#6 AWG – 250 kcmil #4 AWG – 600 kcmil	1/4 – 20 x 3/4 HH	3	1/4 – 20 HN	3	3/8 FLAT	32
		LAMA600-38	3		3/8 – 16 x 2 HH	16	3/8 – 16 HN	16	1/4 FLAT	6
KLM6-800	100 – 167 KVA 1 PH 150 – 300 KVA 3 PH	LAM2A350-12	6	#6 AWG – 350 kcmil 350 kcmil – 800 kcmil	1/2 – 13 x 2 HH	5	1/2 – 13 HN	11	1/2 FLAT	22
		LAM2A800-58	7		1/2 – 13 x 2 1/2 HH	6			1/2 CMP	11
KLM350-800	500 KVA 3 PH	LAM2A800-58	15	350 kcmil – 800 kcmil	1/2 – 13 x 2 HH	7	1/2 – 13 HN	11	1/2 FLAT	22
					1/2 – 13 x 2 1/2 HH	4			1/2 CMP	11

Suffix: HH = Hex Head; HN = Hex Nut; FLAT = Flat Washer; CMP = Compression Washer.

The use of PANDUIT® oxide inhibiting joint compound (CMP-100) is recommended for pad to pad and conductor connections. See [pages H33, F118](#).

Splicer/Reducer

For Use with Stranded Aluminum or Copper Code Conductors

Type SR

- Made from high strength extruded aluminum alloy to provide premium electrical and mechanical performance
- Tin plated to inhibit corrosion
- Rounded bottoms to facilitate taping
- Solid center barrier prevents contact of dissimilar metal conductors
- Wire range-taking capability minimizes inventory requirements
- UL Listed and CSA Certified for use up to 600V and UL temperature rated 90°C

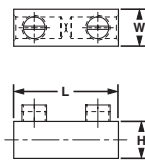

Figure 1

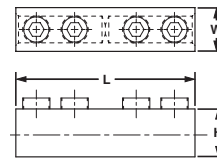

Figure 2

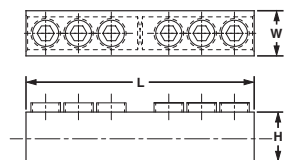

Figure 3

Part Number	Figure No.	Conductor Size Range		Figure Dimensions In.			Hex Key Size (In.)	Tightening Torque (In.-Lbs.)	Std. Pkg. Qty.
		Max.	Min.	L	W	H			
SR-2-X	1	#2 AWG STR, #10 AWG SOL	#14 AWG STR, #14 AWG SOL	1.38	.50	.56	**	50*	10
SR-0-X	1	1/0 AWG STR, #10 AWG SOL	#14 AWG STR, #14 AWG SOL	1.91	.75	.75	**	50*	10
SR-4/0-X	1	4/0 AWG	#6 AWG	2.31	1.00	1.13	5/16	50	10
SR-250-X	2	250 kcmil	#6 AWG	3.94	1.00	1.13	5/16	275	10
SR-350-X	2	350 kcmil	#6 AWG	4.19	1.13	1.19	5/16	275	10
SR-500-3	2	500 kcmil	3/0 AWG	5.00	1.37	1.40	3/8	375	3
SR-750-1	2	750 kcmil	250 kcmil	6.25	1.63	1.75	1/2	500	1
SR-1000-1	3	1000 kcmil	500 kcmil	8.69	1.72	1.88	9/16	600	1

The use of PANDUIT® oxide inhibiting joint compound (CMP-100) is recommended. See [pages H33, F118](#).

*Listed torque values are for maximum conductor sizes, consult the installation instruction sheet for smaller sizes.

**Uses slotted screws.

System Overview



Insulation Piercing Connector

For Use with Stranded Aluminum or Copper Code Conductors

Type IPC

Terminals

- Does not require cable insulation to be stripped, saves time
- Flexible design – can be used as a tap, splice or dead end connector
- For use with outdoor and indoor installation
- Glass filled nylon body provides long term durability
- Hardened copper teeth provide proper penetration of cable insulation for a reliable electrical connection
- UL Listed and CSA Certified for use up to 600V and temperature rated 90°C

Disconnects

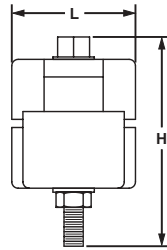
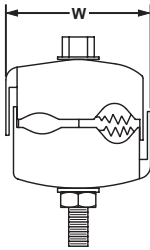

Splices

Ferrules

Part Number	Conductor Size Range		Current Rating (Amps)		Hex Size (In.)		Figure Dimensions (In.)			Tightening Torque (In.-Lbs.)	Std. Pkg. Qty.
	Run	Tap	Copper Conductor Size	Aluminum Conductor Size	Bolt	Hex	L	W	H		
IPC500-250-2	350 kcmil – 500 kcmil	#4 AWG – 250 kcmil	260	205	5/8	11/16	2.42	2.90	3.75	60	2

Compression Connectors



Multi-Tap Connector with Clear Insulation, Single-Sided Entry

For Use with Stranded Aluminum or Copper Code Conductors

Type PCSB-S

Crimping Tools

- Flexible design – can be used as a tap, splice or dead end connector
- Body made from high strength, extruded aluminum alloy to provide premium electrical and mechanical performance
- Insulated with clear PVC to eliminate need for taping and allow for visual inspection of the complete conductor insertion
- Each port pre-filled with oxide inhibiting joint compound seals out air and moisture to deter surface oxidation
- Wire range-taking capability minimizes inventory requirements
- Plated steel or aluminum set screw provides high strength, durable electrical contact between conductor and connector
- UL Listed and CSA Certified for use up to 600V and temperature rated 90°C

Mechanical Connectors

Grounding Connectors

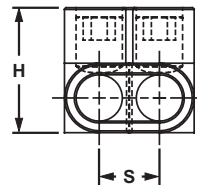
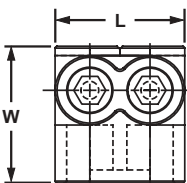

Support Products

Technical Info

Part Number	Conductor Size Range	Number of Ports	Figure Dimensions (In.)				Hex Key Size (In.)	Tightening Torque (In.-Lbs.)	Std. Pkg. Qty.
			L	W	H	S			
PCSB2/0-2S-6	2/0 – #14 AWG STR	2	1.56	1.25	1.31	.72	3/16	50*	6

*Listed torque values are for maximum conductor sizes, consult the installation instruction sheet for smaller sizes.

Index



Multi-Tap Connector with Clear Insulation, Double-Sided Entry

For Use with Stranded Aluminum or Copper Code Conductors

Type PCSB

- Flexible design – can be used as a tap, splice or dead end connector
- Body made from high strength, extruded aluminum alloy to provide premium electrical and mechanical performance
- Insulated with clear PVC to eliminate need for taping and allow for visual inspection of the complete conductor insertion
- Each port pre-filled with oxide inhibiting joint compound seals out air and moisture to deter surface oxidation
- Wire range-taking capability minimizes inventory requirements
- Dual sided entry allows offset and opposite entry for primary and secondary conductors
- Plated steel or aluminum set screw provides high strength, durable electrical contact between conductor and connector
- UL Listed for use up to 600V and temperature rated 90°C

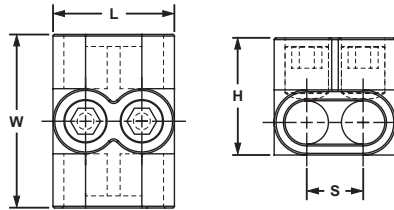

Part Number	Conductor Size Range	Number of Ports	Figure Dimensions (In.)				Hex Key Size (In.)	Tightening Torque (In.-Lbs.)	Std. Pkg. Qty.
			L	W	H	S			
PCSB4-2-12	#4 – #14 AWG STR #10 – #14 AWG SOL	2	1.16	1.50	1.25	.49	**	45*	12
PCSB4-3-12		3	1.64	1.50	1.25	.49	**	45*	12
PCSB4-4-6		4	2.13	1.50	1.25	.49	**	45*	6
PCSB4-5-6		5	2.62	1.50	1.25	.49	**	45*	6
PCSB4-6-6		6	3.10	1.50	1.25	.49	**	45*	6
PCSB4-7-4		7	3.59	1.50	1.25	.49	**	45*	4
PCSB4-8-4		8	4.08	1.50	1.25	.49	**	45*	4
PCSB2/0-2-12		2/0 – #14 AWG STR #10 – #14 AWG SOL	2	1.63	1.60	1.38	.72	3/16	50*
PCSB2/0-3-6	3		2.36	1.60	1.38	.72	3/16	50*	6
PCSB2/0-4-6	4		3.08	1.60	1.38	.72	3/16	50*	6
PCSB2/0-5-6	5		3.81	1.60	1.38	.72	3/16	50*	6
PCSB2/0-6-6	6		4.53	1.60	1.38	.72	3/16	50*	6
PCSB2/0-7-4	7		5.25	1.60	1.38	.72	3/16	50*	4
PCSB2/0-8-4	8		5.98	1.60	1.38	.72	3/16	50*	4
PCSB250-2-6	250 kcmil – #6 AWG STR		2	2.13	2.60	2.13	.97	5/16	275
PCSB250-3-6		3	3.10	2.60	2.13	.97	5/16	275	6
PCSB250-4-6		4	4.06	2.60	2.13	.97	5/16	275	6
PCSB250-5-4		5	5.03	2.60	2.13	.97	5/16	275	4
PCSB250-6-4		6	6.00	2.60	2.13	.97	5/16	275	4
PCSB250-7-3		7	6.98	2.60	2.13	.97	5/16	275	3
PCSB250-8-3		8	7.95	2.60	2.13	.97	5/16	275	3
PCSB350-2-4		350 kcmil – #10 AWG STR #10 AWG SOL	2	2.22	3.00	2.50	1.02	3/8	375
PCSB350-3-4	3		3.24	3.00	2.50	1.02	3/8	375	4
PCSB350-4-3	4		4.25	3.00	2.50	1.02	3/8	375	3
PCSB350-5-3	5		5.28	3.00	2.50	1.02	3/8	375	3
PCSB350-6-2	6		6.30	3.00	2.50	1.02	3/8	375	2
PCSB350-7-2	7		7.31	3.00	2.50	1.02	3/8	375	2
PCSB350-8-2	8		8.33	3.00	2.50	1.02	3/8	375	2
PCSB500-2-4	500 kcmil – #6 AWG STR		2	2.71	3.00	2.75	1.27	3/8	375
PCSB500-3-3		3	4.00	3.00	2.75	1.27	3/8	375	3
PCSB500-4-2		4	5.26	3.00	2.75	1.27	3/8	375	2
PCSB500-5-2		5	6.53	3.00	2.75	1.27	3/8	375	2
PCSB500-6-2		6	7.81	3.00	2.75	1.27	3/8	375	2
PCSB500-7-2		7	9.08	3.00	2.75	1.27	3/8	375	2
PCSB500-8-2		8	10.35	3.00	2.75	1.27	3/8	375	2
PCSB600-5-2 ***		600 kcmil – #4 AWG STR	5	6.43	2.87	2.75	1.31	3/8	375

*Listed torque values are for maximum conductor sizes, consult the installation instruction sheet for smaller sizes.

Uses slotted head set screw. *PCSB600-5-2 is also CSA Certified.

System Overview



In-Line Splicer/Reducer with Clear Insulation

For Use with Stranded Aluminum or Copper Code Conductors

Type PISR

Terminals

- Flexible design – can be used as a splice or reducer
- Dual rated for use with copper or aluminum conductors
- Made from high strength, extruded aluminum alloy to provide premium electrical and mechanical performance
- Insulated with clear PVC to eliminate need for taping and allow for visual inspection of the complete conductor insertion

- Each port pre-filled with oxide inhibiting joint compound seals out air and moisture to deter surface oxidation
- Wire range-taking capability minimizes inventory requirements
- Plated steel or aluminum set screw provides high strength, durable electrical contact between conductor and connector
- UL Listed and CSA Certified for use up to 600V and UL temperature rated 90°C

Disconnects

Splices



Part Number	Conductor Size Range	Figure Dimensions (In.)			Std. Pkg. Qty.
		L	W	H	
PISR2-1	#2 STR – #14 SOL	2.38	.62	1.15	1
PISR1/0-1	1/0 STR – 14 SOL	2.91	.78	1.31	1

Ferrules

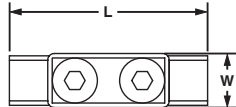

Compression Connectors

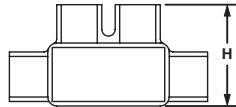

Crimping Tools

Mechanical Connectors

Grounding Connectors

Support Products

Technical Info

Index

Bellelville Compression Washers

Type CW

- Conical spring washer for use when assembling aluminum connectors to copper and/or steel pads, compensates for differing rates of thermal expansion to keep hardware assembly from loosening

- Made from hardened steel to provide high strength
- Cadmium plated to inhibit corrosion

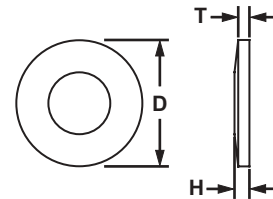
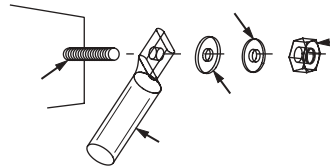

Part Number	Stud Hole Size (In.)	Figure Dimensions (In.)			Std. Pkg. Qty.
		D	H	T	
CW-14-L	1/4	.68	.09	.05	50
CW-56-L	5/16	.81	.08	.06	50
CW-38-L	3/8	.93	.10	.07	50
CW-12-Q	1/2	1.18	.12	.09	25
CW-58-Q	5/8	1.49	.15	.12	25

Joint Compounds

Type CMP

- Oxide inhibitor for compression cable connections made with aluminum compression connectors lowers electrical contact resistance of compression joint while sealing out air and moisture to prevent the formation of surface oxides
- Wide operating temperature range; can be used in a wide range of electrical and environmental conditions

- Non-toxic
- Non-flammable
- Packaged in convenient 8 oz. dispenser bottles



Part Number	Part Description	Std. Pkg. Qty.
CMP-100-1	Contact aid for pad-to-pad or thread-to-thread aluminum connections. Operating temperature range -60°F(-51°C) to 400°F (204°C). Maintains low electrical resistance and seals out air and moisture to prevent the formation of surface oxides.	1
CMP-200-1	Contact aid for cable connections with compression connections made on aluminum conductor. Operating temperature range -40°F (-40°C) to 400°F (204°C). Lowers contact resistance of compression joint and seals out moisture and air to prevent the formation of surface oxides. Compatible with all insulating materials.	1

System Overview

Terminals

Disconnects

Splices

Ferrules

Compression Connectors

Crimping Tools

Mechanical Connectors

Grounding Connectors

Support Products

Technical Info

Index

System Overview

Guidelines for Installing Connectors on Aluminum Conductor Cable:

Terminals



1 **SELECT** the correct connector for your application

- Always use an aluminum conductor with an aluminum connector
- Verify that the connector is marked for the conductor size and type that you are using

Disconnects

Splices



2 **REMOVE** the insulation from insulated cable. See [page G32](#) for *PANDUIT®* cable stripping tools.

- Use care to avoid nicking the conductor strands
- Strip the insulation to the proper length as listed in the installation instruction sheets provided with *PANDUIT®* connectors.

Ferrules

Compression Connectors



3 **CLEAN** the exposed conductor using a wire brush or an emery cloth. In a similar manner, clean an unplated connector pad and the surface to which the connector will be attached. Solvent should be used to clean plated parts that are dirty, but the plating should never be disturbed with abrasives.

Crimping Tools

Mechanical Connectors



4 **APPLY** *PANDUIT®* Joint Compound to the clean conductor for mechanical connector applications (see [pages H33, F118](#)). Joint compound will deter the formation of surface oxides after installation. (Aluminum compression connectors and insulated mechanical connectors are pre-filled with joint compound.)

Grounding Connectors

Support Products



5 **INSERT** the conductor into the connector and:

- a) for mechanical connectors, tighten the screws to the recommended torque values...

OR

- b) for compression connectors, use the recommended die and crimping tool to make the proper compression connection

Technical Info

Index

PAN-LUG[™] GROUNDING CONNECTORS

PANDUIT[®] PAN-LUG[™] Grounding Connectors provide innovative solutions for joining ground conductor to water pipe, ground rods, conduit, iron pipe and structural steel. PAN-LUG[™] mechanical grounding connectors are designed with the needs of the end user in mind focusing on easy installation, lowest installed cost and long-term reliability.

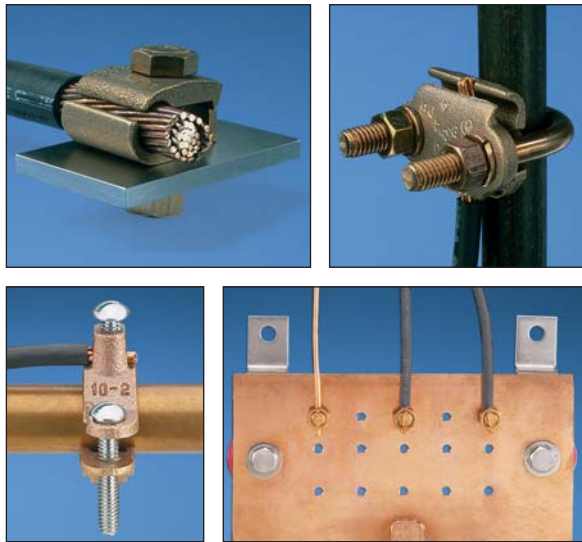

- Functional product information is marked directly on the connector, facilitating the identification, ordering and usage of the grounding connector
- Designed for easy installation — no special tooling required
- Incorporate wire range-taking capability to minimize inventory requirements
- Made from high strength, high conductivity electrolytic copper and aluminum alloy materials to provide optimum connectivity for power and grounding applications
- Include plated or silicon bronze hardware to inhibit corrosion
- Copper and bronze grounding connectors are UL Listed for direct burial in earth and concrete, as noted
- UL Listed per UL 467 for grounding and bonding, as noted

PANDUIT[®] PAN-LUG[™] Grounding Connectors are available in a variety of configurations, including water pipe clamps, bronze grounding clamps and bronze service post connectors.

PANDUIT[®] offers a wide assortment of PAN-LUG[™] Power and Grounding Connectors to meet customer needs and today's application requirements.

System Overview

Terminals

Disconnects

Splices

Ferrules

Compression Connectors

Crimping Tools

Mechanical Connectors

Grounding Connectors

Support Products

Technical Info

Index

System Overview

Terminals

Disconnects

Splices

Ferrules

Compression Connectors

Crimping Tools

Mechanical Connectors

Grounding Connectors

Support Products

Technical Info

Index

Features and Benefits — PAN-LUG™ Grounding Connectors

Bronze Grounding Clamp



Made from high strength, electrolytic cast bronze

Provides two options: attachment of grounding conductor to clamp either parallel or perpendicular to axis of pipe or ground rod

Provided with high strength, corrosion resistant silicon bronze hardware

Part number, conductor range, rod and pipe size range and "DB" suitable for direct burial marked on part for easy identification



Bronze Service Post Connector



Part number, conductor range and "DB" suitable for direct burial marked on part for easy identification

Made from a single piece of hard drawn copper electrolytic rod — provides high strength

Provided with high strength, corrosion resistant silicon bronze nut and pressure pad

Available in configurations for use with one or two copper conductors with either a standard or long stud length



Bronze Water Pipe Clamp





Part number, conductor range, water pipe size range and "DB" suitable for direct burial marked on part for easy identification

Provided with high strength steel hardware plated to inhibit corrosion

Made from high strength, electrolytic cast bronze

Each part accommodates a wide range of copper conductor sizes and water pipe sizes — minimizes inventory

Bronze Grounding Clamp

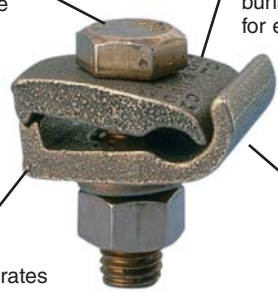

Provided with high strength, corrosion resistant silicon bronze hardware

Part number, conductor range and "DB" suitable for direct burial marked on part for easy identification

Made from high strength, electrolytic cast bronze

Spacer separates conductor from mounting surface



Ground Rod Clamp





Made from high strength, electrolytic cast bronze





Provided with high strength, corrosion resistant silicon bronze hardware

Designed to maintain proper alignment between ground rod and conductor during installation

Part number, conductor range, ground rod size and "DB" suitable for direct burial marked on part for easy identification

Selection Guide — PAN-LUG™ Grounding Connectors

UL Listed Direct Burial	Service Post Type	Stud Size (In.)	Thread Length (In.)	Copper Code Conductor Size																	
				#12 AWG	#10 AWG	#8 AWG	#7 AWG	#6 AWG	#4 AWG	#3 AWG	#2 AWG	#1 AWG	1/0 AWG	2/0 AWG	3/0 AWG	4/0 AWG	250 kcmil	300 kcmil	350 kcmil	400 kcmil	500 kcmil
				PANDUIT® Part Number																	
	Bronze Service Post One Conductor SP1	1/4-20	1/2	SP1-8-C*																	
			1	SP1-8L-C*																	
			1/2		SP1-7-C*																
			1		SP1-7L-C*																
		5/16-18	9/16	SP1-4-C*																	
			1	SP1-4L-C*																	
		3/8-16	5/8	SP1-3-C*																	
			1 1/8	SP1-3L-C*																	
			5/8	SP1-2-C																	
		1/2-13	1 1/8	SP1-2L-C																	
			3/4	SP1-1/0-L*																	
			1 1/4	SP1-1/0L-L*																	
			3/4	SP1-2/0-Q*																	
		5/8-11	1 1/4	SP1-2/0L-Q*																	
			1			SP1-4/0-Q*															
			1 1/2			SP1-4/0L-Q*															
1				SP1-350-12																	
3/4-10	1 1/2			SP1-350L-12																	
	1 3/8			SP1-500-12																	
	1 3/4			SP1-500L-12																	
	Bronze Service Post Two Conductors SP2	1/4-20	1/2	SP2-8-C*																	
			1	SP2-8L-C*																	
			1/2		SP2-7-C*																
			1		SP2-7L-C*																
		5/16-18	9/16	SP2-4-C*																	
			1	SP2-4L-C*																	
		3/8-16	5/8	SP2-3-C*																	
			1 1/8	SP2-3L-C*																	
			5/8	SP2-2-C*																	
		1/2-13	1 1/8	SP2-2L-C*																	
			3/4			SP2-1/0-L*															
			1 1/4			SP2-1/0L-L*															
			3/4			SP2-2/0-Q*															
		5/8-11	1 1/4			SP2-2/0L-Q*															
			1			SP2-4/0-Q*															
			1 1/2			SP2-4/0L-Q*															
1				SP2-350-12																	
3/4-10	1 1/2			SP2-350L-12																	
	1 3/8			SP2-500-12																	
	1 3/4			SP2-500L-12																	
	Bronze Service Post One Conductor SPF1	1/4-20	1/4	SPF1-8-C*																	
				SPF1-7-C*																	
		5/16-18	5/16	SPF1-4-C*																	
				SPF1-3-C																	
		3/8-16	3/8	SPF1-2-C																	
				SPF1-1/0L*																	
		1/2-13	7/16	SPF1-2/0-Q*																	
1/2	SPF1-4/0-Q																				
5/8-11	5/8	SPF1-350-12																			
		SPF1-500-12																			
3/4-10	3/4	SPF1-500L-12																			
		Bronze Service Post Two Conductors SPF2	1/4-20	1/4	SPF2-8-C*																
				SPF2-7-C*																	
5/16-18			5/16	SPF2-4-C*																	
				SPF2-3-C*																	
3/8-16			3/8	SPF2-2-C*																	
				SPF2-1/0-L*																	
1/2-13			7/16	SPF2-2/0-Q*																	
			1/2	SPF2-4/0-Q*																	
5/8-11	5/8	SPF2-350-12																			
		SPF2-500-12																			
3/4-10	3/4	SPF2-500L-12																			

*Denotes minimum conductor size is solid conductor.

Selection Guide continues on [page J4](#).

- System Overview
- Terminals
- Disconnects
- Splices
- Ferrules
- Compression Connectors
- Crimping Tools
- Mechanical Connectors
- Grounding Connectors
- Support Products
- Technical Info
- Index

System Overview Selection Guide — PAN-LUG™ Grounding Connectors (continued)

System Overview	UL Listed Direct Burial	Ground Clamp Type	Ground Rod Size (In.)	Pipe Size (In.)	Copper Code Conductor Size																			
					#14 AWG	#12 AWG	#10 AWG	#8 AWG	#7 AWG	#6 AWG	#4 AWG	#3 AWG	#2 AWG	#1 AWG	1/0 AWG	2/0 AWG	3/0 AWG	4/0 AWG	250 kcmil	300 kcmil	350 kcmil	400 kcmil	500 kcmil	
					PANDUIT® Part Number																			
Terminals		Bronze Ground Clamp One Conductor GPL	5/8 or 3/4	3/8	GPL-4-Q*				GPL-5-Q*				GPL-6-Q*											
					GPL-8-Q*				GPL-9-Q*				GPL-10-Q*											
			7/8 or 1	1/2 or 3/4	GPL-14-X*				GPL-15-X*				GPL-16-X*											
					GPL-20-X*				GPL-21-X*				GPL-22-X*											
			—	1 1/4	GPL-26-X*				GPL-27-X*				GPL-28-X*											
					GPL-32-3*				GPL-33-3*				GPL-34-3*											
			—	1 1/2	GPL-39-3*				GPL-40-3*															
					GPL-44-1*				GPL-45-1*				GPL-46-1*											
			—	2	GPL-51-1*				GPL-52-1*															
					GPL-57-1*				GPL-58-1*															
—	2 1/2	GU-2-X* ‡																						
		GU-4-X* ‡																						
—	1 1/4																	GU-13-3 ‡						
																		GU-13-3 ‡						
Disconnects		Bronze Ground Clamp Two Conductors GU	—	1																	GU-13-3 ‡			
																					GU-13-3 ‡			
Splices		Bronze Ground Clamp One Conductor GPL	—	1 1/2																	GU-13-3 ‡			
																					GU-13-3 ‡			
Ferrules		Bronze Ground Clamp One Conductor GPL	—	2																	GU-13-3 ‡			
																					GU-13-3 ‡			
Compression Connectors		Bronze Ground Clamp One Conductor GPL	—	3 1/2																	GU-13-3 ‡			
																					GU-13-3 ‡			
Crimping Tools		Bronze Ground Clamp One Conductor GPL	—	4																	GU-13-3 ‡			
																					GU-13-3 ‡			
Mechanical Connectors		Bronze Ground Clamp One Conductor GPL	—	1																	GU-13-3 ‡			
																					GU-13-3 ‡			
Grounding Connectors		Bronze Ground Clamp One Conductor GPL	—	1 1/4																	GU-13-3 ‡			
																					GU-13-3 ‡			
Support Products		Bronze Ground Clamp One Conductor GPL	—	2																	GU-13-3 ‡			
																					GU-13-3 ‡			
Technical Info		Bronze Ground Clamp One Conductor GPL	—	3 1/2																	GU-13-3 ‡			
																					GU-13-3 ‡			
Index		Bronze Ground Clamp One Conductor GPL	—	4																	GU-13-3 ‡			
																					GU-13-3 ‡			

*Denotes minimum conductor size is solid conductor. @Denotes not UL Listed for Direct Burial.
 DR Denotes Dual Rated for use with copper or aluminum conductors. ‡ Denotes not UL Listed or CSA Certified.

cUL^{us} Service Post Connector, Male Stud, Single Conductor, Bronze

Type SP1

- For grounding one copper code conductor to steel structures, bus bars or transformers or for tapping from bus bar with hex nut and washer
- Made from high copper content, hard drawn copper rod provides high strength
- Offered with standard and long stud lengths to accommodate a variety of mounting applications
- Wire range-taking capability minimizes inventory requirements
- True hex design for body and nut hex provides correct fit with socket, box or open end wrenches resulting in proper torquing of electrical connection
- Pressure bar provides secure connection on a full range of conductor combinations used with each connector providing premium wire pull-out strength
- UL Listed for grounding and bonding and suitable for direct burial in earth or concrete

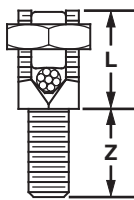

Part Number	Conductor Size Range	Stud Size*	Figure Dimensions (In.)		Nut Hex (In.)	Body Hex (In.)	Tightening Torque (In.-Lbs.)	Std. Pkg. Qty.
			L	Z				
SP1-8-C	#12 SOL – #8 STR	1/4 – 20	.63	.50	.50	.38	80	100
SP1-8L-C			.63	1.00				
SP1-7-C	#8 SOL – #7 STR	1/4 – 20	.88	.50	.69	.50	165	100
SP1-7L-C			.88	1.00				
SP1-4-C	#10 SOL – #4 STR	5/16 – 18	.94	.56	.75	.56	240	100
SP1-4L-C			.94	1.00				
SP1-3-C	#6 SOL – #3 STR	3/8 – 16	1.06	.63	.81	.63	275	100
SP1-3L-C			1.06	1.13				
SP1-2-C	#4 STR – #2 STR	3/8 – 16	1.06	.63	.88	.69	385	100
SP1-2L-C			1.06	1.13				
SP1-1/0-L	#6 SOL – 1/0 STR	1/2 – 13	1.31	.75	1.00	.75	385	50
SP1-1/0L-L			1.31	1.25				
SP1-2/0-Q	#1 SOL – 2/0 STR	1/2 – 13	1.44	.75	1.13	.88	500	25
SP1-2/0L-Q			1.44	1.25				
SP1-4/0-Q	3/0 SOL – 4/0 STR	5/8 – 11	1.69	1.00	1.38	1.13	650	25
SP1-4/0L-Q			1.69	1.50				
SP1-350-12	4/0 STR – 350 kcmil	5/8 – 11	2.00	1.00	1.50	1.25	650	12
SP1-350L-12			2.00	1.50				
SP1-500-12	250 kcmil – 500 kcmil	3/4 – 10	2.31	1.38	1.81	1.50	825	12
SP1-500L-12			2.31	1.75				

*UNC threads.

System Overview

Terminals

Disconnects

Splices

Ferrules

Compression Connectors

Crimping Tools

Mechanical Connectors

Grounding Connectors

Support Products

Technical Info

Index

System Overview

cUL_{us} Service Post Connector, Male Stud, Two Conductor, Bronze

Type SP2

Terminals

- For grounding two copper code conductors to steel structures, bus bars or transformers or for tapping from bus bar with hex nut and washer
- Made from high copper content, hard drawn copper rod provides high strength

- True hex design for body and nut hex provides correct fit with socket, box or open end wrenches resulting in proper torquing of electrical connection

Disconnects

- Offered with standard and long stud lengths to accommodate a variety of mounting applications
- Wire range-taking capability minimizes inventory requirements

- Pressure bar provides secure connection on a full range of conductor combinations used with each connector providing premium wire pull-out strength
- UL Listed for grounding and bonding and suitable for direct burial in earth or concrete



Splices

Ferrules

Compression Connectors

Crimping Tools

Mechanical Connectors

Grounding Connectors

Support Products

Technical Info

Index

Part Number	Conductor Size Range	Stud Size*	Figure Dimensions (In.)		Nut Hex (In.)	Body Hex (In.)	Tightening Torque (In.-Lbs.)	Std. Pkg. Qty.
			L	Z				
SP2-8-C	#12 SOL – #8 STR	1/4 – 20	.75	.50	.50	.38	80	100
SP2-8L-C			.75	1.00				
SP2-7-C	#10 SOL – #7 STR	1/4 – 20	1.00	.50	.69	.50	165	100
SP2-7L-C			1.00	1.00				
SP2-4-C	#10 SOL – #4 STR	5/16 – 18	1.16	.56	.75	.56	240	100
SP2-4L-C			1.16	1.00				
SP2-3-C	#10 SOL – #3 STR	3/8 – 16	1.09	.63	.81	.63	275	100
SP2-3L-C			1.09	1.13				
SP2-2-C	#10 SOL – #2 STR	3/8 – 16	1.38	.63	.88	.69	385	100
SP2-2L-C			1.28	1.13				
SP2-1/0-L	#2 SOL – 1/0 STR	1/2 – 13	1.69	.75	1.00	.75	385	50
SP2-1/0L-L			1.69	1.25				
SP2-2/0-Q	#2 SOL – 2/0 STR	1/2 – 13	1.88	.75	1.13	.88	500	25
SP2-2/0L-Q			1.88	1.25				
SP2-4/0-Q	#1 SOL – 4/0 STR	5/8 – 11	2.25	1.00	1.38	1.13	650	25
SP2-4/0L-Q			2.25	1.50				
SP2-350-12	#1 STR – 350 kcmil	5/8 – 11	2.69	1.00	1.50	1.25	650	12
SP2-350L-12			2.69	1.50				
SP2-500-12	3/0 STR – 500 kcmil	3/4 – 10	3.19	1.38	1.81	1.50	825	12
SP2-500L-12			3.19	1.75				

*UNC threads.

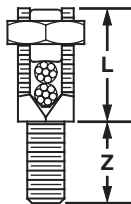

cULus Service Post Connector, Female Thread, Single Conductor, Bronze

Type SPF1

- For grounding one copper code conductor to steel structures, bus bars or transformers or for tapping from bus bar using external studs, screws or bolts
- Made from high copper content, hard drawn copper rod provides high strength
- Wire range-taking capability minimizes inventory requirements
- True hex design for body and nut hex provides correct fit with socket, box or open end wrenches resulting in proper torquing of electrical connection
- Pressure bar provides secure connection on a full range of conductor combinations used with each connector providing premium wire pull-out strength
- UL Listed for grounding and bonding and suitable for direct burial in earth or concrete

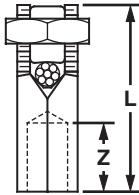

Part Number	Conductor Size Range	Thread Size*	Figure Dimensions (In.)		Nut Hex (In.)	Body Hex (In.)	Tightening Torque (In.-Lbs.)	Std. Pkg. Qty.
			L	Z				
SPF1-8-C	#12 SOL – #8 STR	1/4 – 20	.91	.25	.50	.38	80	100
SPF1-7-C	#10 SOL – #7 STR	1/4 – 20	1.13	.25	.69	.50	165	100
SPF1-4-C	#8 SOL – #4 STR	5/16 – 18	1.44	.31	.75	.56	240	100
SPF1-3-C	#6 STR – #3 STR	3/8 – 16	1.50	.38	.81	.63	275	100
SPF1-2-C	#6 STR – #2 STR	3/8 – 16	1.63	.38	.88	.69	385	100
SPF1-1/0-L	#2 SOL – 1/0 STR	1/2 – 13	1.88	.44	1.00	.75	385	50
SPF1-2/0-Q	#1 SOL – 2/0 STR	1/2 – 13	2.06	.50	1.13	.88	500	25
SPF1-4/0-Q	1/0 STR – 4/0 STR	5/8 – 11	2.38	.63	1.38	1.13	650	25
SPF1-350-12	4/0 STR – 350 kcmil	5/8 – 11	2.63	.63	1.50	1.25	650	12
SPF1-500-12	300 kcmil – 500 kcmil	3/4 – 10	3.13	.75	1.81	1.50	825	12

*UNC threads.

System Overview

Terminals

Disconnects

Splices

Ferrules

Compression Connectors

Crimping Tools

Mechanical Connectors

Grounding Connectors

Support Products

Technical Info

Index

System Overview

cULus Service Post Connector, Female Thread, Two Conductor, Bronze

Type SPF2

Terminals

- For grounding two copper code conductors to steel structures, bus bars or transformers or for tapping from bus bar using external threaded studs, screws or bolts
- Made from high copper content, hard drawn copper rod provides high strength
- Wire range-taking capability minimizes inventory requirements
- True hex design for body and nut hex provides correct fit with socket, box or open end wrenches resulting in proper torquing of electrical connection
- Pressure bar provides secure connection on a full range of conductor combinations used with each connector providing premium wire pull-out strength
- UL Listed for grounding and bonding and suitable for direct burial in earth or concrete

Disconnects

Splices



Ferrules

Compression Connectors

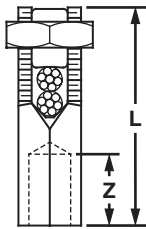

Crimping Tools

Mechanical Connectors

Grounding Connectors

Support Products

Technical Info

Index

Part Number	Conductor Size Range	Thread Size*	Figure Dimensions (In.)		Nut Hex (In.)	Body Hex (In.)	Tightening Torque (In.-Lbs.)	Std. Pkg. Qty.
			L	Z				
SPF2-8-C	#12 SOL – #8 STR	1/4 – 20	1.13	.25	.50	.38	80	100
SPF2-7-C	#10 SOL – #7 STR	1/4 – 20	1.44	.25	.69	.50	165	100
SPF2-4-C	#10 SOL – #4 STR	5/16 – 18	1.56	.31	.75	.56	240	100
SPF2-3-C	#10 SOL – #3 STR	3/8 – 16	1.63	.38	.81	.63	275	100
SPF2-2-C	#10 SOL – #2 STR	3/8 – 16	1.94	.38	.88	.69	385	100
SPF2-1/0-L	#2 SOL – 1/0 STR	1/2 – 13	2.13	.44	1.00	.75	385	50
SPF2-2/0-Q	#2 SOL – 2/0 STR	1/2 – 13	2.31	.50	1.13	.88	500	25
SPF2-4/0-Q	#1 SOL – 4/0 STR	5/8 – 11	2.50	.63	1.38	1.13	650	25
SPF2-350-12	#1 STR – 350 kcmil	5/8 – 11	2.69	.63	1.50	1.25	650	12
SPF2-500-12	3/0 STR – 500 kcmil	3/4 – 10	3.31	.75	1.81	1.50	825	12

*UNC threads.

cULus Grounding Clamp, U-Bolt, Bronze

Type GPL

- Used to ground copper conductor parallel or at a right angle to a rod, tube or pipe
- Made from high strength, electrolytic cast bronze
- High strength silicon bronze hardware provides long-term reliable assembly
- Accommodates a wide range of pipe, tube, rod and conductor sizes — minimizes inventory
- UL Listed for grounding and bonding and suitable for direct burial in earth or concrete

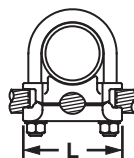
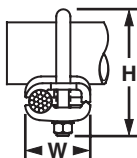

Part Number	Ground Rod Size (In.)	Iron Pipe Size (In.)	Conductor Size Range	Figure Dimensions (In.)			Bolt Dia. (In.)	Hex Size (In.)	Tightening Torque (In.-Lbs.)	Std. Pkg. Qty.
				L	W	H				
GPL-4-Q	5/8 or 3/4	3/8	#8 SOL – #4 STR	2.00	1.38	2.75	3/8	9/16	110	25
GPL-5-Q	5/8 or 3/4	3/8	#4 SOL – 2/0 STR	2.00	1.63	2.75	3/8	9/16	180	25
GPL-6-Q	5/8 or 3/4	3/8	2/0 SOL – 250 kcmil	2.00	1.88	2.75	3/8	9/16	240	25
GPL-8-Q	7/8 or 1	1/2 or 3/4	#8 SOL – #4 STR	2.38	1.38	2.63	3/8	9/16	110	25
GPL-9-Q	7/8 or 1	1/2 or 3/4	#4 SOL – 2/0 STR	2.38	1.63	2.63	3/8	9/16	180	25
GPL-10-Q	7/8 or 1	1/2 or 3/4	2/0 SOL – 250 kcmil	2.38	1.88	3.00	3/8	9/16	240	25
GPL-14-X	—	1	#8 SOL – #4 STR	2.63	1.38	2.75	3/8	9/16	110	10
GPL-15-X	—	1	#4 SOL – 2/0 STR	2.63	1.63	2.75	3/8	9/16	180	10
GPL-16-X	—	1	2/0 SOL – 250 kcmil	2.63	1.88	3.25	3/8	9/16	180	10
GPL-20-X	—	1 1/4	#8 SOL – #4 STR	3.00	1.38	3.50	3/8	9/16	110	10
GPL-21-X	—	1 1/4	#4 SOL – 2/0 STR	3.00	1.63	3.50	3/8	9/16	180	10
GPL-22-X	—	1 1/4	2/0 SOL – 250 kcmil	3.00	1.88	3.50	3/8	9/16	240	10
GPL-26-X	—	1 1/2	#8 SOL – #4 STR	3.25	1.38	4.00	3/8	9/16	110	10
GPL-27-X	—	1 1/2	#4 SOL – 2/0 STR	3.25	1.63	4.00	3/8	9/16	180	10
GPL-28-X	—	1 1/2	2/0 SOL – 250 kcmil	3.25	1.88	4.00	3/8	9/16	240	10
GPL-32-3	—	2	#8 SOL – #4 STR	3.75	1.38	4.25	3/8	9/16	110	3
GPL-33-3	—	2	#4 SOL – 2/0 STR	3.75	1.63	4.25	3/8	9/16	180	3
GPL-34-3	—	2	2/0 SOL – 250 kcmil	3.75	1.88	4.25	3/8	9/16	240	3
GPL-39-3	—	2 1/2	#4 SOL – 2/0 STR	4.25	1.63	5.00	3/8	9/16	180	3
GPL-40-3	—	2 1/2	2/0 SOL – 250 kcmil	4.25	1.88	5.00	3/8	9/16	240	3
GPL-44-1	—	3	#8 SOL – #4 STR	4.75	1.38	5.50	.38	9/16	180	1
GPL-45-1	—	3	#4 SOL – 2/0 STR	4.75	1.63	5.50	3/8	9/16	180	1
GPL-46-1	—	3	2/0 SOL – 250 kcmil	4.75	1.88	5.50	3/8	9/16	240	1
GPL-51-1	—	3 1/2	#4 SOL – 2/0 STR	5.25	1.63	6.25	3/8	9/16	180	1
GPL-52-1	—	3 1/2	2/0 SOL – 250 kcmil	5.25	1.88	6.25	3/8	9/16	180	1
GPL-57-1	—	4	#4 SOL – 2/0 STR	5.75	1.63	6.38	3/8	9/16	180	1
GPL-58-1	—	4	2/0 SOL – 250 kcmil	5.75	1.88	6.38	3/8	9/16	240	1

System Overview

Terminals

Disconnects

Splices

Ferrules

Compression Connectors

Crimping Tools

Mechanical Connectors

Grounding Connectors

Support Products

Technical Info

Index

System Overview

Grounding Clamp, U-Bolt, for Two Cables, Bronze Type GU

Terminals



- Used to ground two copper code conductors parallel or at a right angle to a rod, tube or pipe
- Made from high strength, electrolytic cast bronze
- High strength silicon bronze hardware provides long term reliable assembly
- Accommodates a wide range of pipe, tube, rod and conductor sizes — minimizes inventory
- UL Listed for grounding and bonding and suitable for direct burial in earth or concrete

Disconnects

Part Number	Iron Pipe Size (In.)	Conductor Size Range	Figure Dimensions (In.)			Bolt Dia. (In.)	Hex Size (In.)	Tightening Torque (In.-Lbs.)	Std. Pkg. Qty.
			L	W	H				
GU-2-X	1	#4 SOL – 2/0 STR	2.75	1.13	3.25	3/8	9/16	240	10
GU-4-X	1 1/4	#8 SOL – #4 STR	3.00	1.13	3.25	3/8	9/16	240	10
GU-13-3	2	300 kcmil – 500 kcmil	4.00	1.50	4.63	1/2	3/4	480	3

Splices

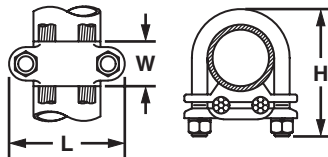

Ferrules

UL LISTED / NSF CERTIFIED Grounding Clamp for Water Pipes, Bronze Type KP

Compression Connectors



- Used to ground copper code conductor to water pipe or copper tube
- Cast from high strength, electrolytic bronze to provide reliable grounding connections
- Plated steel screws provide high strength and inhibit corrosion
- Accommodates a wide range of pipe, tube, rod and conductor sizes — minimizes inventory
- UL Listed for grounding and bonding and suitable for direct burial in earth or concrete

Crimping Tools

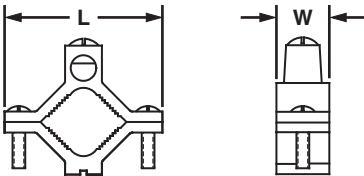

Part Number	Water Pipe Range (In.)	Conductor Size Range	Figure Dimensions (In.)		Tightening Torque (In.-Lbs.)		Std. Pkg. Qty.
			L	W	Conductor	Clamp	
KP1-C	1/2 – 1	#10 SOL – #2 STR	2.28	.66	50	50	100
KP2-L	1 1/4 – 2	#10 SOL – #2 STR	3.58	.73	50	50	50

Mechanical Connectors

Grounding Clamp for Water Pipe with Copper Strap, Bronze Type KLS

Grounding Connectors

- Used to ground copper code conductor to rigid conduit systems
- Cast from high strength, electrolytic bronze to provide reliable grounding connections
- Plated steel screws provide high strength and inhibit corrosion
- Pure copper contact strip included to isolate conduit system from water pipe vibrations
- High strength bronze conduit hub also included to provide durable connection of conduit to copper strap
- Accommodates a wide range of pipe, tube and conductor sizes — minimizes inventory

Support Products

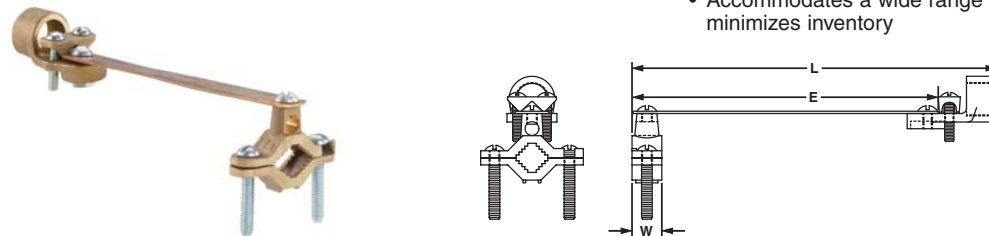

Technical Info

Part Number	Conduit Hub Size	Water Pipe Range (In.)	Conductor Size Range	Figure Dimensions (In.)			Tightening Torque (In.-Lbs.)		Std. Pkg. Qty.
				L	W	E	Conductor	Clamp	
KLS-0-Q	1/2	1/2 – 1	#10 SOL – 2/0 STR	8.22	.66	6 7/8	50	50	25
KLS-1-Q	3/4	1/2 – 1	#10 SOL – 2/0 STR	8.22	.66	6 7/8	50	50	25
KLS-1A-X	1	1/2 – 1	#10 SOL – 2/0 STR	8.38	.66	6 7/8	50	50	10

Index

Grounding Clamp for Conduit, Bronze

Type KH

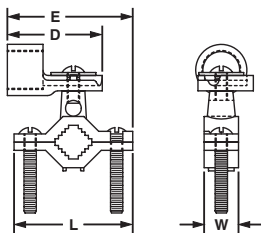

- Used to ground copper code conductor to rigid conduit systems
- Cast from high strength, electrolytic bronze to provide reliable grounding connections
- Plated steel screws provide high strength and inhibit corrosion
- Includes high strength bronze conduit hub to ensure a durable connection of conduit to copper strap
- Accommodates a wide range of pipe, tube and conductor sizes — minimizes inventory

Part Number	Conduit Hub Size	Water Pipe Range (In.)	Conductor Size Range	Figure Dimensions (In.)			Tightening Torque (In.-Lbs.)		Std. Pkg. Qty.	
				L	W	E	D	Conductor		Clamp
KH-1-L	1/2	1/2 – 1	#10 SOL – #4 STR	2.31	.66	2.54	1.85	50	50	50
KH-2-L	1/2	1 1/4 – 2	#10 SOL – #4 STR	3.60	.79	3.02	1.85	50	50	50

UL LISTED Grounding Clamp for Water Pipes, Aluminum

Type GC

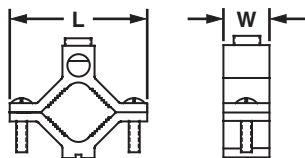

- Dual rated for grounding aluminum or copper code conductors to copper water pipe, galvanized pipe or steel conduit
- Made from high strength, extruded aluminum alloy to provide long term durability
- Tin plated to inhibit corrosion and oxidation and for low contact resistance
- Plated steel screws provide high strength and inhibit corrosion
- Accommodates a wide range of pipe, tube and conductor sizes — minimizes inventory
- UL Listed for grounding and bonding

Part Number	Conduit Pipe or Water Tube Size	Conductor Size Range	Figure Dimensions (In.)		Tightening Torque (In.-Lbs.)		Std. Pkg. Qty.
			L	W	Conductor	Clamp	
GC-15A-Q	1/2 – 3/4 – 1	#14 AWG – 1/0 AWG	2.25	.69	50	50	25
GC-18A-X	1 1/4 – 1, 1/2 – 2	#6 AWG – 250 kcmil	3.75	.81	50	50	10
GC-22A-4	2 1/2 – 3 – 3 1/2 – 4	#6 AWG – 250 kcmil	6.31	1.00	50	50	4

UL LISTED CSA CERTIFIED Grounding Rod Clamp, Bronze

Type WB

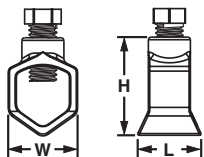

- Used for grounding copper conductor parallel to ground rods
- Made from high strength, seamless electrolytic bronze to provide long term durability
- High strength silicon bronze hardware provides long term reliable assembly
- Accommodates a wide range of rod and conductor sizes — minimizes inventory
- UL Listed and CSA Certified for grounding and bonding and suitable for direct burial in earth and concrete

Part Number	Ground Rod Size	Conductor Size Range	Figure Dimensions (In.)			Hex Size (In.)	Tightening Torque (In.-Lbs.)	Std. Pkg. Qty.
			L	W	H			
WB12-L	1/2	#2 – #10 STR, #10 SOL	.88	.84	1.28	1/2	180	50
WB34-X	5/8	1/0 – #8 STR	1.03	1.06	1.54	1/2	180	10
WB58-Q	3/4	#2 – #8 STR	1.04	.92	1.40	1/2	180	25

System Overview

cUL_{us} Grounding Clamp for Flat Surfaces, Bronze

Type GMS

Terminals



- Used to ground copper code conductor to flat surfaces
- Cast from high strength, electrolytic bronze to provide reliable grounding connections
- High strength silicon bronze hardware for long term reliable assembly
- Accommodates a wide range of conductor sizes — minimizes inventory
- UL Listed for grounding and bonding and suitable for direct burial in earth or concrete

Disconnects

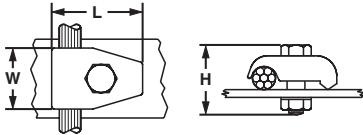

Part Number	Conductor Size Range	Figure Dimensions (In.)			Hex Size (In.)		Tightening Torque (In.-Lbs.)	Std. Pkg. Qty.
		L	W	H	Bolt	Nut		
GMS-1-X	#8 SOL – #4 STR	1.25	1.00	1.63	9/16	9/16	240	10
GMS-2-Q	#4 SOL – 2/0 STR	1.63	1.13	1.75	9/16	9/16	240	25
GMS-3-Q	2/0 SOL – 250 kcmil	2.13	1.50	2.00	3/4	3/4	480	25

Splices

Ferrules

cUL_{us} Grounding Clamp with Spacer for Flat Surfaces, Bronze

Type GM

Compression Connectors



- Used to ground copper code conductor to flat surfaces
- Cast from high strength, electrolytic bronze to provide reliable grounding connections
- High strength silicon bronze hardware for long term reliable assembly
- Accommodates a wide range of conductor sizes — minimizes inventory
- Incorporates spacer plate to separate conductor from mounting surface
- UL Listed for grounding and bonding and suitable for direct burial in earth or concrete

Crimping Tools

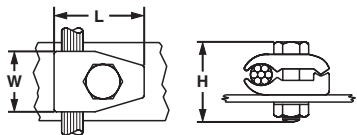

Part Number	Conductor Size Range	Figure Dimensions (In.)			Hex Size (In.)		Tightening Torque (In.-Lbs.)	Std. Pkg. Qty.
		L	W	H	Bolt	Nut		
GM-2-Q	#4 SOL – 2/0 STR	1.63	1.13	1.75	9/16	9/16	240	25
GM-3-Q	2/0 SOL – 250 kcmil	2.13	1.50	2.00	3/4	3/4	480	25

Mechanical Connectors

Grounding Connectors

Support Products

Technical Info

Index

SUPPORT PRODUCTS

PANDUIT® is a leading global producer of electrical products, including REEL SMART™ System, heat shrink, printers, software, labels and cable ties. These products complement the complete termination solution and make PANDUIT® the best source for all your electrical needs.

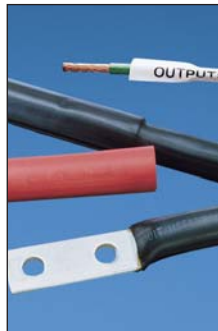

- PANDUIT® REEL SMART™ System provides the best solution for quality, high volume terminations designed to dramatically reduce set-up time and downtime. The REEL SMART™ continuously molded offering provides product for virtually any insulation application, including the industry's only continuously molded right angle disconnects, butt splices, and the largest reel-fed expanded barrel disconnect offering. (For more information go to www.panduit.com/reelsmart.)



- PANDUIT® heat shrink products provide an economical and easy way to insulate, protect, harness and color code electrical/electronic components and cable in a wide variety of sizes and materials. (For more information go to www.panduit.com/heatshrink or request catalog SA-CTCB03.)



- PANDUIT® labeling products, software and printers assist with proper identification of wires and cable. (For more information go to www.panduit.com/idproducts or request catalog SA-IDCB16.)
- PANDUIT® cable ties are available in a broad selection of sizes, styles, materials and colors. Industry leading installation tools are offered to speed installation and lower installed cost. (For more information go to www.panduit.com/cableties or request catalog SA-CTCB03.)

PANDUIT® continually provides new designs with innovative features to meet the application challenges encountered by customers, while providing the lowest installed cost.

System Overview

Terminals

Disconnects

Splices

Ferrules

Compression Connectors

Crimping Tools

Mechanical Connectors

Grounding Connectors

Support Products

Technical Info

Index

System Overview

Continuously Molded Reel-Fed *TERMO*™ Terminals, Butt Splices and *DISCO*™ — *DISCOGRIP*™ Continuously Molded Reel-Fed Disconnects

Terminals

Disconnects

Splices

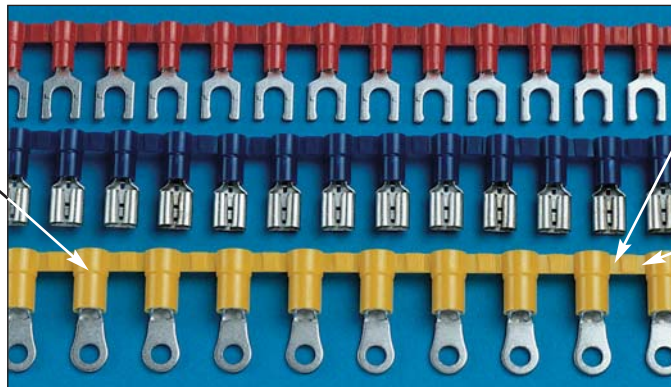

Pre-insulated design eliminates the need for post-insulation — resulting in labor savings

Continuously molded design always aligns product with the carrier strip — resulting in trouble free tool operation

Plastic carrier strip eliminates sharp, unplated edges as found on metal strip-fed carriers — providing better corrosion resistance

Ferrules

The PANDUIT® continuously molded *REEL SMART*™ products are designed such that the terminal, disconnect, and butt splice housings are connected by an integral molded carrier in the barrel crimp zone, producing a continuous length of product. Plated metal terminals, disconnects and splices are then assembled into the housings. During termination, the continuously molded components are fed into a universal applicator. This process produces a reel-fed solution that eliminates a variety of problems associated with other reel-fed designs and provides high quality, high capacity product on reels for longer, uninterrupted production runs — resulting in the lowest installed cost.

Compression Connectors

Crimping Tools

Automatic, self-adjusting feed stroke — resulting in correct pitch and length

Mechanical Connectors

Grounding Connectors

Versatile applicator design — allows for use in bench presses, and most automatic wire processing systems

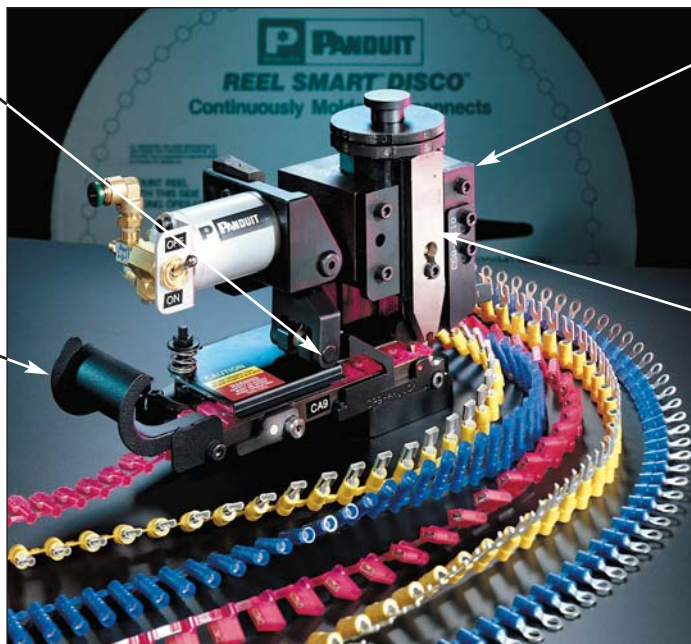

Universal applicator installs entire *REEL SMART*™ product line — resulting in lower tooling inventory costs

Quick change dies — provide fast product change-over and reduction in set-up time

Support Products

Technical Info

The PANDUIT® CA9 *EZAIR*™ applicator automatically adjusts feed stroke to the correct pitch and length for the entire product line of continuously molded products. The need for multiple applicators is eliminated. The applicator, in conjunction with the precision, continuously molded product provides perfect front-to-back and side-to-side alignment in the die pocket for a high quality termination every time — resulting in the most optimum system to terminate terminals.

Index

Nylon Insulated Terminals with Insulation Grip Sleeve (Funnel & Non-Funnel Entry Types)

The 3-piece design terminal provides a permanently attached tin plated brass sleeve for insulation grip in funnel and straight entry sleeve designs. This product feature offers the highest quality reliable terminations. Nylon insulation is rated up to 600V maximum and designed for up to 105°C (221°F) operating temperature maximum. Supplied on rings, forks, locking forks, short locking forks and flanged forks in wire sizes #22 through #10.



- Sleeved Barrel – assures crimp reliability
- PNF – funnel-entry styles available
- Metal Insulation Crimp – provides DOUBLE CRIMP wire insulation grip sleeve for high vibration or conductor strain environments
- Internal Wire Barrel Serrations – assure good wire contact and maximum tensile strength
- Product Markings – UL and CSA Rated – up to 600V, maximum operating temperature 105° C (221° F)

The PVC insulation forms an insulation crimp on the wire insulation. Supplied on #22 – #10 rings, forks, locking forks, short locking forks and flanged forks. All polyvinylchloride 2-piece insulated terminals are rated up to 600V maximum and designed for up to 105°C (221°F) operating temperature maximum.

Performance Requirements

	Wire Size (AWG)								
	#26	#24	#22	#20	#18	#16	#14	#12	#10
UL 486A (TERMINALS), UL310 (MALE BLADE ADAPTERS)									
Test Current for Max. 50° Rise (Amps)	3.5	7	9	12	17	18	30	35	50
Min. Tensile Strength* (Lbs.)	3	5	8	13	20	30	50	70	80
UL 486C (SPLICES)									
Test Current for Max. 50°C Rise (Amps)	5.5	7	9	12	17	18	30	35	50
Min. Tensile Strength* (Lbs.)	3	5	8	10	10	15	25	35	40

*Pull-out force of the crimped terminal

Applicable *PAN-TERM*® products meet or exceed the following test specifications:

- UL486A (Terminals)
- UL486C (Splices)
- UL310 (Blade Adapters)
- CSA C22.2 No. 65 (all designs)

UL and CSA approved products are shown with the applicable logos in the product section.

UL file #E52164, CSA File #LR31212

Part Number System for *REEL SMART*™ Terminals

Type	Insulation	Wire Range	Stud Size	Tongue Configuration	Special Configuration	Std. Pkg. Size
P = Terminal BS = Butt Splice	N = Nylon Insulated NF = Nylon Insulated Funnel Entry V = Vinyl Insulated	18 = #22 - 18 14 = #16 - 14 12 = #16 - 12 10 = #12 - 10	4 = #4 5 = #5 6 = #6 8 = #8 10 = #10 14 = 1/4" 56 = 5/16" 38 = 3/8"	R = Ring HDR = Heavy Duty Ring F = Fork FF = Fanged Fork LF = Locking Fork SLF = Short Locking Fork P47 = Pin	N = Narrow Tongue W = Wide Tongue B = Butted Seam = Standard (leave blank)	2K = 2,000 pcs. 3K = 3,000 pcs.

System Overview  **Ring Terminals, Nylon Insulated — Non-Funnel Entry**

Type PN-R

- Metal insulation grip sleeve

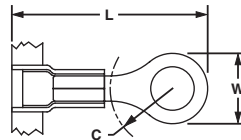

Disconnects	Part Number	Wire Range	Color Code	Stock Thickness	Max. Ins.	Stud Size	Figure Dimension (In.)			CA9 Series Crimp Die	CA-800 Series Crimp Die	Pieces Per Reel
							L	W	C			
Splices	PN18-4R-3K	22-18 AWG	Red	.03	.136	#4	.80	.25	.22	CD9-1A	CD-800-1	3000
	PN18-6RN-3K					#6	.74	.22	.18			3000
	PN18-6R-3K					#6	.78	.25	.22			3000
	PN18-8R-3K					#8	.86	.31	.25			3000
	PN18-10R-3K					#10	.86	.31	.25			3000
	PN18-14R-3K					1/4"	1.05	.45	.38			3000
Ferrules	PN14-4R-3K	16-14 AWG	Blue	.03	.162	#4	.76	.25	.22	CD9-2A	CD-800-2	3000
	PN14-6RN-3K					#6	.76	.25	.22			3000
	PN14-6R-3K					#6	.86	.31	.25			3000
	PN14-8R-3K					#8	.86	.31	.25			3000
	PN14-10R-3K					#10	.86	.31	.25			3000
	PN14-14R-3K					1/4"	1.06	.44	.38			3000
Compression Connectors	PN10-6R-2K	12-10 AWG	Yellow	.04	.225	#6	1.04	.38	.31	CD9-3B	CD-800-3	2000
	PN10-8R-2K					#8	1.04	.38	.31			2000
	PN10-10R-2K					#10	1.04	.38	.31			2000
	PN10-14R-2K					1/4"	1.19	.52	.38			2000
	PN10-56R-2K					5/16"	1.19	.52	.38			2000
	PN10-38R-2K					3/8"	1.27	.58	.43			2000

Crimping Tools  **Ring Terminals, Nylon Insulated — Funnel Entry**

Type PNF-R

- Funnel entry
- Metal insulation grip sleeve

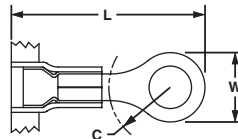

Grounding Connectors	Part Number	Wire Range	Color Code	Stock Thickness	Max. Ins.	Stud Size	Figure Dimensions (In.)			CA9 Series Crimp Die	CA-800 Series Crimp Die	Pieces Per Reel
							L	W	C			
Support Products	PNF18-4RN-3K	22-18 AWG	Red	.03	.145	#4	.74	.22	.19	CD9-1A	CD-800-1	3000
	PNF18-4R-3K					#4	.78	.25	.21			3000
	PNF18-6RN-3K					#6	.74	.22	.16			3000
	PNF18-6R-3K					#6	.78	.25	.21			3000
	PNF18-8R-3K					#8	.86	.31	.25			3000
	PNF18-10R-3K					#10	.86	.31	.25			3000
Technical Info	PNF18-14R-3K	16-14 AWG	Blue	.03	.162	1/4"	1.06	.46	.38	CD9-2A	CD-800-2	3000
	PNF14-4R-3K					#4	.78	.25	.18			3000
	PNF14-6RN-3K					#6	.78	.25	.18			3000
	PNF14-6R-3K					#6	.87	.31	.24			3000
	PNF14-8R-3K					#8	.87	.31	.25			3000
	PNF14-10R-3K					#10	.85	.31	.29			3000
Index	PNF14-14R-3K	12-10 AWG	Yellow	.04	.225	1/4"	1.06	.46	.40	CD9-3B	CD-800-3	3000
	PNF10-6R-2K					#6	1.04	.38	.31			2000
	PNF10-8R-2K					#8	1.04	.38	.31			2000
	PNF10-10R-2K					#10	1.04	.38	.31			2000
	PNF10-14R-2K					1/4"	1.19	.52	.38			2000
	PNF10-56R-2K					5/16"	1.19	.52	.38			2000
PNF10-38R-2K	3/8"	1.27	.58	.43	2000							



Ring Terminals, Vinyl Insulated — Funnel Entry

Type PV-RB

- Funnel entry
- Insulation support

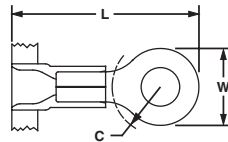

Part Number	Wire Range	Color Code	Stock	Max. Ins.	Stud Size	Figure Dimensions (In.)			CA9 Series Crimp Die	CA-800 Series Crimp Die	Pieces Per Reel						
						L	W	C									
PV18-4RNB-3K	22-18 AWG	Red	.03	.150	#4	.75	.21	.19	CD9-1A	CD-800-1	3000						
PV18-4RB-3K					#4	.78	.25	.21			3000						
PV18-6RNB-3K					#6	.75	.23	.19			3000						
PV18-6RB-3K					#6	.78	.25	.21			3000						
PV18-8RB-3K					#8	.86	.31	.28			3000						
PV18-10RB-3K					#10	.86	.31	.28			3000						
PV18-14RB-3K					1/4"	1.06	.45	.41			3000						
PV18-56RB-2K					5/16"	1.06	.46	.38			2000						
PV18-38RB-2K					3/8"	1.15	.53	.43			2000						
PV14-4RB-3K					16-14 AWG	Blue	.03	.170			#4	.76	.25	.22	CD9-2A	CD-800-2	3000
PV14-6RNB-3K	#6	.76	.25	.22					3000								
PV14-6RB-3K	#6	.86	.31	.25					3000								
PV14-8RB-3K	#8	.86	.31	.25					3000								
PV14-10RB-3K	#10	.86	.31	.25					3000								
PV14-14RB-3K	1/4"	1.05	.45	.38					3000								
PV14-56RB-2K	5/16"	1.06	.46	.38					2000								
PV14-38RB-2K	3/8"	1.15	.53	.43					2000								
PV10-6RB-2K	12-10 AWG	Yellow	.04	.225					#6	1.02	.31	.31	CD9-3B	CD-800-3			2000
PV10-8RB-2K									#8	1.02	.31	.31					2000
PV10-10RB-2K					#10	1.02	.31	.31	2000								
PV10-14RB-2K					1/4"	1.20	.52	.38	2000								
PV10-56RB-2K					5/16"	1.20	.52	.38	2000								
PV10-38RB-2K					3/8"	1.23	.58	.38	2000								



Ring Terminals, Vinyl Insulated — Multiple Stud

Type PV-610RB

- Single terminal for #6 #8 and #10 stud sizes
- Insulation support
- Funnel entry

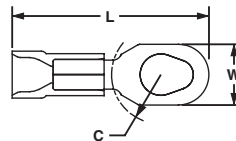

Part Number	Wire Range	Color Code	Stock Thickness	Max. Ins.	Stud Size	Figure Dimensions (In.)			CA9 Series Crimp Die	CA-800 Series Crimp Die	Pieces Per Reel
						L	W	C			
PV18-610RB-3K	22-18 AWG	Red	.03	.150	#6,	.95	.31	.25	CD9-1A	CD-800-1	3000
PV14-610RB-3K	16-14 AWG	Blue	.03	.170	#8,	.95	.31	.25	CD9-2A	CD-800-2	3000
PV10-610RB-2K	12-10 AWG	Yellow	.04	.225	#10	1.17	.37	.31	CD9-3B	CD-800-3	2000

System Overview

Terminals

Disconnects

Splices

Ferrules

Compression Connectors

Crimping Tools

Mechanical Connectors

Grounding Connectors

Support Products

Technical Info

Index

System Overview



Ring Terminals, Nylon Insulated — Heavy Duty

Terminals

Type PN-HDR

- Metal insulation grip sleeve
- Heavy stock

Disconnects

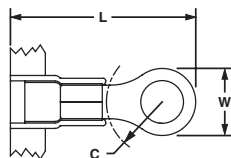

Splices

Part Number	Wire Range	Color Code	Stock Thickness	Max. Ins.	Stud Size	Figure Dimensions (In.)			CA9 Series Crimp Die	CA-800 Series Crimp Die	Pieces Per Reel
						L	W	C			
PN12-6HDR-2K	16-12 AWG	Yellow	.05	.225	#6	1.02	.31	.31	CD9-3B	CD-800-3	2000
PN12-8HDR-2K					#8	1.02	.31	.31			2000
PN12-10HDR-2K					#10	1.05	.38	.31			2000
PN12-14HDR-2K					1/4"	1.20	.52	.38			2000
PN12-56HDR-2K					5/16"	1.20	.52	.38			2000
PN12-38HDR-2K					3/8"	1.28	.58	.43			2000

Ferrules

Compression Connectors



Ring Terminals, Vinyl Insulated — Heavy Duty

Type PV-HDRB

- Funnel entry
- Insulation support
- Heavy stock

Crimping Tools

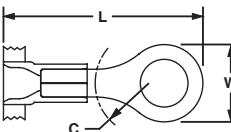

Mechanical Connectors

Part Number	Wire Range	Color Code	Stock Thickness	Max. Ins.	Stud Size	Figure Dimensions (In.)			CA9 Series Crimp Die	CA-800 Series Crimp Die	Pieces Per Reel
						L	W	C			
PV12-6HDRB-2K	16-12 AWG	Yellow	.05	.225	#6	1.03	.31	.36	CD9-3B	CD-800-3	2000
PV12-8HDRB-2K					#8	1.03	.31	.36			2000
PV12-10HDRB-2K					#10	1.06	.37	.36			2000
PV12-14HDRB-2K					1/4"	1.23	.52	.43			2000
PV12-56HDRB-2K					5/16"	1.23	.52	.43			2000
PV12-38HDRB-2K					3/8"	1.30	.58	.48			2000

Grounding Connectors

Support Products

Technical Info

Index



Fork Terminals, Nylon Insulated — Non-Funnel Entry

Type PN-F

- Metal insulation grip sleeve

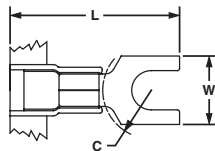

Part Number	Wire Range	Color Code	Stock Thickness	Max. Ins.	Stud Size	Figure Dimensions (In.)			CA9 Series Crimp Die	CA-800 Series Crimp Die	Pieces Per Reel
						L	W	C			
PN18-6FN-3K*	22-18 AWG	Red	.03	.145	#6	.78	.25	.20	CD9-1A	CD-800-1	3000
PN18-6F-3K					#6	.78	.30	.20			3000
PN18-8F-3K					#8	.85	.32	.23			3000
PN18-10FN-3K*					#10	.86	.31	.25			3000
PN18-10F-3K					#10	.86	.35	.25			3000
PN18-14F-3K					1/4"	1.03	.44	.33			3000
PN14-6FN-3K*	16-14 AWG	Blue	.03	.162	#6	.78	.24	.19	CD9-2A	CD-800-2	3000
PN14-6F-3K					#6	.78	.28	.19			3000
PN14-8F-3K					#8	.84	.31	.23			3000
PN14-10FN-3K*					#10	.86	.31	.24			3000
PN14-10F-3K					#10	.86	.34	.24			3000
PN14-14F-3K					1/4"	1.03	.44	.32			3000
PN10-6F-2K	12-10 AWG	Yellow	.04	.225	#6	.98	.31	.24	CD9-3B	CD-800-3	2000
PN10-8F-2K					#8	1.01	.37	.24			2000
PN10-10F-2K					#10	1.02	.37	.24			2000
PN10-14F-2K					1/4"	1.12	.49	.32			2000
											2000

*Not UL Listed or CSA Certified.



Fork Terminals, Nylon Insulated — Funnel Entry

Type PNF-F

- Funnel entry
- Metal insulation grip sleeve

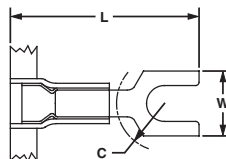

Part Number	Wire Range	Color Code	Stock Thickness	Max. Ins.	Stud Size	Figure Dimensions (In.)			CA9 Series Crimp Die	CA-800 Series Crimp Die	Pieces Per Reel						
						L	W	C									
PNF18-6FN-3K	22-18 AWG	Red	.03	.145	#6	.77	.24	.19	CD9-1A	CD-800-1	3000						
PNF18-6F-3K					#6	.78	.30	.19			3000						
PNF18-8F-3K					#8	.83	.32	.22			3000						
PNF18-10F-3K					#10	.85	.35	.24			3000						
PNF18-14F-3K					1/4"	1.02	.44	.33			3000						
PNF14-6FN-3K					16-14 AWG	Blue	.03	.162			#6	.78	.24	.19	CD9-2A	CD-800-2	3000
PNF14-6F-3K	#6	.78	.28	.19					3000								
PNF14-8F-3K	#8	.84	.31	.23					3000								
PNF14-10F-3K	#10	.86	.34	.24					3000								
PNF10-6F-2K	12-10 AWG	Yellow	.04	.225					#6	.99	.31	.24	CD9-3B	CD-800-3			2000
									#8	1.00	.37	.24					2000

System Overview



Fork Terminals, Vinyl Insulated — Funnel Entry

Terminals

Type PV-FB

- Funnel entry
- Insulation support

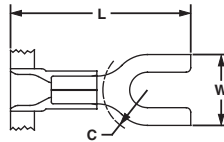

Disconnects

Splices

Part Number	Wire Range	Color Code	Stock Thickness	Max. Ins.	Stud Size	Figure Dimensions (In.)			CA9 Series Crimp Die	CA-800 Series Crimp Die	Pieces Per Reel
						L	W	C			
PV18-6FNB-3K*	22-18 AWG	Red	.03	.150	#6	.78	.25	.20	CD9-1A	CD-800-1	3000
PV18-6FB-3K					#6	.78	.30	.20			3000
PV18-8FB-3K					#8	.84	.32	.23			3000
PV18-10FB-3K					#10	.86	.35	.25			3000
PV18-14FB-3K					1/4"	1.03	.44	.33			3000
PV14-6FNB-3K*	16-14 AWG	Blue	.03	.170	#6	.78	.24	.19	CD9-2A	CD-800-2	3000
PV14-6FB-3K					#6	.78	.28	.19			3000
PV14-8FB-3K					#8	.84	.31	.23			3000
PV14-10FNB-3K*					#10	.86	.31	.24			3000
PV14-10FB-3K					#10	.86	.34	.24			3000
PV14-14FB-3K	1/4"	1.03	.44	.32	3000						
PV10-6FB-2K	12-10 AWG	Yellow	.04	.225	#6	.99	.30	.22	CD9-3B	CD-800-3	2000
PV10-8FB-2K					#8	1.00	.30	.22			2000
PV10-10FB-2K					#10	1.04	.34	.22			2000
PV10-14FB-2K					1/4"	1.13	.49	.32			2000

*Not UL Listed or CSA Certified.

Crimping Tools



Locking Fork Terminals, Nylon Insulated — Non-Funnel Entry

Mechanical Connectors

Type PN-LF

- Metal insulation grip sleeve

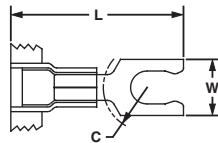

Grounding Connectors

Support Products

Part Number	Wire Range	Color Code	Stock Thickness	Max. Ins.	Stud Size	Figure Dimensions (In.)			CA9 Series Crimp Die	CA-800 Series Crimp Die	Pieces Per Reel
						L	W	C			
PN18-6LF-3K	22-18 AWG	Red	.03	.136	#6	.82	.27	.19	CD9-1A	CD-800-1	3000
PN18-8LF-3K					#8	.89	.29	.23			3000
PN18-10LF-3K					#10	.89	.33	.23			3000
PN14-6LF-3K	16-14 AWG	Blue	.03	.162	#6	.85	.25	.18	CD9-2A	CD-800-2	3000
PN14-8LF-3K					#8	.92	.29	.23			3000
PN14-10LF-3K					#10	.92	.33	.23			3000
PN10-6LF-2K	12-10 AWG	Yellow	.04	.225	#6	1.00	.30	.21	CD9-3B	CD-800-3	2000
PN10-8LF-2K					#8	1.03	.30	.21			2000
PN10-10LF-2K					#10	1.03	.34	.21			2000

Technical Info

Index



Locking Fork Terminals, Nylon Insulated — Funnel Entry

Type PNF-LF

- Funnel entry
- Metal insulation grip sleeve

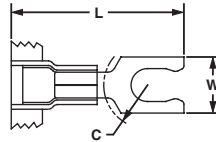

Part Number	Wire Range	Color Code	Stock Thickness	Max. Ins.	Stud Size	Figure Dimensions (In.)			CA9 Series Crimp Die	CA-800 Series Crimp Die	Pieces Per Reel
						L	W	C			
PNF18-6LF-3K	22-18 AWG	Red	.03	.136	#6	.85	.27	.19	CD9-1A	CD-800-1	3000
PNF18-6LFW-3K					#6	.85	.29	.19			3000
PNF18-8LF-3K					#8	.89	.29	.23			3000
PNF18-10LF-3K					#10	.89	.33	.23			3000
PNF14-6LF-3K	16-14 AWG	Blue	.03	.162	#6	.85	.25	.18	CD9-2A	CD-800-2	3000
PNF14-8LF-3K					#8	.92	.29	.23			3000
PNF14-10LFN-3K*					#10	.92	.28	.23			3000
PNF14-10LF-3K					#10	.92	.33	.23			3000
PNF10-6LF-2K	12-10 AWG	Yellow	.04	.225	#6	1.00	.30	.21	CD9-3B	CD-800-3	2000
PNF10-8LF-2K					#8	1.03	.30	.21			2000
PNF10-10LF-2K					#10	1.03	.34	.21			2000
PNF10-14LF-2K					1/4"	1.17	.46	.32			2000

*Not UL Listed or CSA Certified.



Locking Fork Terminals, Vinyl Insulated — Funnel Entry

Type PV-LFB

- Funnel entry
- Plastic insulation crimp

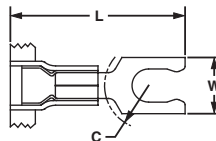

Part Number	Wire Range	Color Code	Stock Thickness	Max. Ins.	Stud Size	Figure Dimensions (In.)			CA9 Series Crimp Die	CA-800 Series Crimp Die	Pieces Per Reel
						L	W	C			
PV18-6LFB-3K	22-18 AWG	Red	.03	.150	#6	.80	.27	.19	CD9-1A	CD-800-1	3000
PV18-6LFWB-3K					#6	.82	.29	.19			3000
PV18-8LFB-3K					#8	.86	.29	.23			3000
PV18-10LFNB-3K*					#10	.86	.29	.23			3000
PV18-10LFB-3K					#10	.86	.33	.23			3000
PV14-6LFB-3K	16-14 AWG	Blue	.03	.170	#6	.85	.25	.18	CD9-2A	CD-800-2	3000
PV14-6LFWB-3K					#6	.85	.29	.18			3000
PV14-8LFB-3K					#8	.92	.29	.23			3000
PV14-10LFB-3K					#10	.92	.33	.23			3000
PV10-6LFB-2K	12-10 AWG	Yellow	.04	.225	#6	1.02	.30	.21	CD9-3B	CD-800-3	2000
PV10-8LFB-2K					#8	1.04	.30	.21			2000
PV10-10LFB-2K					#10	1.04	.34	.21			2000
PV10-14LFB-2K					1/4"	1.16	.46	.32			2000

*Not UL Listed or CSA Certified.

System Overview

Terminals

Disconnects

Splices

Ferrules

Compression Connectors

Crimping Tools

Mechanical Connectors

Grounding Connectors

Support Products

Technical Info

Index

System Overview



Short Locking Fork Terminals, Nylon Insulated — Non-Funnel Entry

Type PN-SLF

- Metal insulation grip sleeve

Terminals

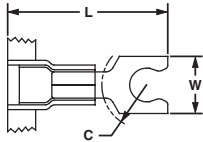

Disconnects

Part Number	Wire Range	Color Code	Stock Thickness	Max. Ins.	Stud Size	Figure Dimensions (In.)			CA9 Series Crimp Die	CA-800 Series Crimp Die	Pieces Per Reel
						L	W	C			
PN18-5SLF-3K	22-18 AWG	Red	.03	.145	#5	.75	.26	.19	CD9-1A	CD-800-1	3000
PN18-6SLF-3K					#6	.75	.27	.19			3000
PN18-8SLF-3K					#8	.79	.29	.23			3000
PN18-10SLF-3K					#10	.80	.33	.23			3000
PN14-5SLF-3K	16-14 AWG	Blue	.03	.162	#5	.75	.25	.19	CD9-2A	CD-800-2	3000
PN14-6SLF-3K					#6	.75	.25	.19			3000
PN14-8SLF-3K					#8	.80	.29	.23			3000
PN14-10SLF-3K					#10	.81	.33	.23			3000
PN10-8SLF-2K	12-10 AWG	Yellow	.04	.225	#8	.90	.29	.22	CD9-3B	CD-800-3	2000
PN10-10SLF-2K					#10	.90	.33	.22			2000

Splices

Ferrules

Compression Connectors



Short Locking Fork Terminals, Nylon Insulated — Funnel Entry

Type PNF-SLF

- Funnel entry
- Metal insulation grip sleeve

Crimping Tools

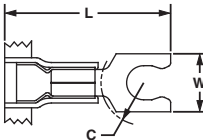

Mechanical Connectors

Part Number	Wire Range	Color Code	Stock Thickness	Max. Ins.	Stud Size	Figure Dimensions (In.)			CA9 Series Crimp Die	CA-800 Series Crimp Die	Pieces Per Reel
						L	W	C			
PNF18-5SLF-3K	22-18 AWG	Red	.03	.145	#5	.72	.26	.19	CD9-1A	CD-800-1	3000
PNF18-6SLF-3K					#6	.72	.27	.19			3000
PNF18-8SLF-3K					#8	.77	.29	.23			3000
PNF18-10SLF-3K					#10	.78	.33	.23			3000
PNF14-6SLF-3K	16-14 AWG	Blue	.03	.162	#6	.75	.25	.19	CD9-2A	CD-800-2	3000
PNF14-10SLF-3K					#10	.81	.33	.23			3000
PNF10-8SLF-2K	12-10 AWG	Yellow	.04	.225	#8	.90	.29	.22	CD9-3B	CD-800-3	2000
PNF10-10SLF-2K					#10	.91	.33	.22			2000

Grounding Connectors

Support Products

Technical Info

Index



Short Locking Fork Terminals, Vinyl Insulated — Funnel Entry

Type PV-SLFB

- Funnel entry
- Insulation support

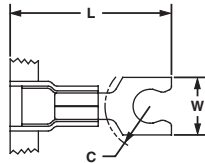

Part Number	Wire Range	Color Code	Stock Thickness	Max. Ins.	Stud Size	Figure Dimensions (In.)			CA9 Series Crimp Die	CA-800 Series Crimp Die	Pieces Per Reel
						L	W	C			
PV18-5SLFB-3K	22-18 AWG	Red	.03	.150	#5	.72	.26	.19	CD9-1A	CD-800-1	3000
PV18-6SLFB-3K					#6	.72	.27	.19			3000
PV18-8SLFB-3K					#8	.77	.29	.23			3000
PV18-10SLFB-3K					#10	.78	.33	.23			3000
PV14-6SLFB-3K	16-14 AWG	Blue	.03	.170	#6	.75	.25	.19	CD9-2A	CD-800-2	3000
PV14-8SLFB-3K					#8	.80	.29	.23			3000
PV14-10SLFB-3K					#10	.81	.33	.23			3000
PV14-14SLFB-3K					1/4"	.90	.44	.29			3000
PV10-6SLFB-2K	12-10 AWG	Yellow	.04	.225	#6	.84	.25	.17	CD0-3B	CD-800-3	2000
PV10-8SLFB-2K					#8	.90	.29	.22			2000
PV10-10SLFB-2K					#10	.91	.33	.22			2000



Flanged Fork Terminals, Nylon Insulated — Non-Funnel Entry

Type PN-FF

- Metal insulation grip sleeve

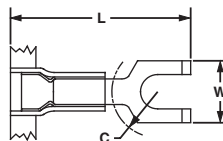

Part Number	Wire Range	Color Code	Stock Thickness	Max. Ins.	Stud Size	Figure Dimensions (In.)			CA9 Series Crimp Die	CA-800 Series Crimp Die	Pieces Per Reel
						L	W	C			
PN18-6FF-3K	22-18 AWG	Red	.03	.136	#6	.80	.28	.19	CD9-1A	CD-800-1	3000
PN18-8FF-3K					#8	.87	.31	.23			3000
PN18-10FF-3K					#10	.87	.35	.23			3000
PN14-6FF-3K	16-14 AWG	Blue	.03	.162	#6	.80	.28	.19	CD9-2A	CD-800-2	3000
PN14-8FF-3K					#8	.87	.31	.23			3000
PN14-10FF-3K					#10	.87	.35	.23			3000
PN10-8FF-2K	12-10 AWG	Yellow	.04	.225	#8	1.03	.38	.22	CD9-3B	CD-800-3	2000
PN10-10FF-2K					#10	1.03	.38	.22			2000

System Overview

Terminals

Disconnects

Splices

Ferrules

Compression Connectors

Crimping Tools

Mechanical Connectors

Grounding Connectors

Support Products

Technical Info

Index

System Overview **UL LISTED** **SP CERTIFIED** **Flanged Fork Terminals, Nylon Insulated — Funnel Entry**

- Type PNF-FF**
- Metal insulation grip sleeve
 - Funnel entry

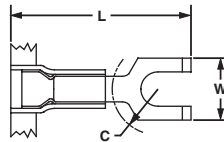

Part Number	Wire Range	Color Code	Stock Thickness	Max. Ins.	Stud Size	Figure Dimensions (In.)			CA9 Series Crimp Die	CA-800 Series Crimp Die	Pieces Per Reel
						L	W	C			
PNF18-6FF-3K	22-18 AWG	Red	.03	.145	#6	.80	.28	.19	CD9-1A	CD-800-1	3000
PNF18-8FF-3K					#8	.87	.31	.23			3000
PNF18-10FF-3K					#10	.86	.35	.23			3000
PNF14-6FF-3K	16-14 AWG	Blue	.03	.162	#6	.80	.28	.19	CD9-2A	CD-800-2	3000
PNF14-8FF-3K					#8	.87	.31	.23			3000
PNF14-10FF-3K					#10	.87	.35	.23			3000
PNF10-8FF-2K	12-10 AWG	Yellow	.04	.225	#8	1.03	.38	.24	CD9-3B	CD-800-3	2000
PNF10-10FF-2K					#10	1.03	.38	.24			2000

Compression Connectors **UL LISTED** **SP CERTIFIED** **Flanged Fork Terminals, Vinyl Insulated — Funnel Entry**

- Type PV-FFB**
- Funnel entry
 - Insulation support

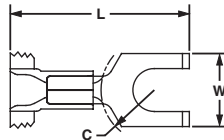

Part Number	Wire Range	Color Code	Stock Thickness	Max. Ins.	Stud Size	Figure Dimensions (In.)			CA9 Series Crimp Die	CA-800 Series Crimp Die	Pieces Per Reel
						L	W	C			
PV18-6FFB-3K	22-18 AWG	Red	.03	.150	#6	.80	.28	.19	CD9-1A	CD-800-1	3000
PV18-8FFB-3K					#8	.87	.31	.23			3000
PV18-10FFB-3K					#10	.86	.35	.23			3000
PV14-6FFB-3K	16-14 AWG	Blue	.03	.170	#6	.80	.28	.19	CD9-2A	CD-800-2	3000
PV14-8FFB-3K					#8	.86	.31	.23			3000
PV14-10FFB-3K					#10	.86	.31	.23			3000
PV10-8FFB-2K	12-10 AWG	Yellow	.04	.225	#8	1.03	.37	.22	CD9-3B	CD-800-3	2000
PV10-10FFB-2K					#10	1.03	.37	.22			2000

Technical Info

Index

Pin Terminals, Vinyl Insulated

Type PV-PB

- Funnel entry
- Insulation support

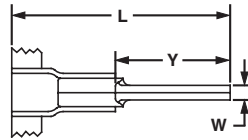

Part Number	Wire Range	Color Code	Max. Ins.	Figure Dimensions (In.)			CA9 Series Crimp Die	CA-800 Series Crimp Die	Pieces Per Reel
				L	W	Y			
PV18-P47B-3K	22-18 AWG	Red	.155	.89	.08	.47	CD9-1A	CD-800-1	3000
PV14-P47B-3K	16-14 AWG	Blue	.180	.89	.08	.47	CD9-2A	CD-800-2	3000

Male Blade Adapters, Vinyl Insulated — Funnel Entry

Type DV-MB

- Funnel entry
- Insulation support

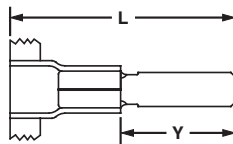

Part Number	Wire Range	Color Code	Max. Ins.	Figure Dimensions (In.)		Tab Size In.	CA9 Series Crimp Die	CA-800 Series Crimp Die	Pieces Per Reel
				L	Y				
DV18-145MB-3K	22-18 AWG	Red	.155	.90	.42	.145 x .032	CD9-1A	CD-800-1	3000
DV14-145MB-3K	16-14 AWG	Blue	.175	.90	.42	.145 x .032	CD9-2A	CD-800-2	3000

Butt Splices Nylon Insulated and Premium Grade Nylon

Type BSN, BSP

- One side machine applied termination replaces manual crimping
- Available with insulation crimp premium grade nylon
- Barrel locating ribs provide for accurate hand tool placement
- Brazed seam with center wire stop for increased performance and productivity
- Funnel entry on machine termination side to increase productivity
- Also hand crimped with *PANDUIT®* CT-100 or CT-1550/CT1551 crimping tools

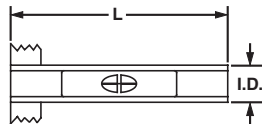

Part Number	Wire Range	Color Code	Max. Ins.	Figure Dimensions (In.)		CA9 Series Crimp Die	CA-800 Series Crimp Die	Pieces Per Reel
				L	I.D.			
BSN18-3K	22-16 AWG	Red	.150	.95	.05	CD9-1A	CD-800-1	3000
BSN14-3K	18-14 AWG	Blue	.170	.95	.07	CD9-2A	CD-800-2	3000
BSN10-2K	12-10 AWG	Yellow	.230	.95	.12	CD9-17B	CD-800-17	2000
BSP18-3K	22-16 AWG	Red	.150	.96	.05	CD9-1A	CD-800-1	3000
BSP14-3K	18-14 AWG	Blue	.170	.96	.07	CD9-2A	CD-800-2	3000

System Overview

Features and Benefits — REEL SMART™ Disconnects

Terminals

SUPRA-GRIP™ Nylon Fully Insulated Funnel Entry, Female Receptacle Type DNG-FB

Available in tab sizes to accommodate .187" or .250" tabs

Fully insulated design provides protection from electrical shorts

Maximum insulation temperature 105°C (221°F)

Fully integrated metal insulation grip for high vibration, high strain relief and double crimp requirements.

Continuously molded design provides reliable, consistent performance through applicator

Funnel entry for faster wire insertion and lower installed cost



Disconnects

Splices

Ferrules

Compression Connectors



*UL and CSA Rated up to 600V per UL310

Crimping Tools

Standard and Premium Nylon Fully Insulated, Funnel Entry, Females Receptacles and Male Tabs Type DNF and DPF

Available in tab sizes to accommodate .110", .187", .205" or .250" tabs

Fully insulated design provides protection from electrical shorts

Maximum insulation temperature 125°C (257°F)

Expanded wire entry (on select sizes) accommodates large insulation or multiple wires

Continuously molded design provides reliable, consistent performance through applicator

Insulation support restricts excessive wire movement to minimize stress on crimp joint

Funnel entry for faster wire insertion and lower installed cost

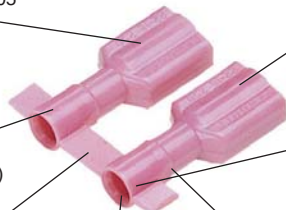

Mechanical Connectors

Grounding Connectors

Support Products

Technical Info

Index



*UL and CSA Rated up to 600V per UL310

DISCO-LOK™ Nylon Fully Insulated, Funnel Entry, Female Receptacle Type DNG-FL

Available in tab sizes to accommodate .250" tabs

Unique locking mechanism allows for low insertion (mating) and positive locking for secure connections

Maximum insulation temperature 105°C (221°F)

Continuously molded design provides reliable, consistent performance through applicator

Funnel entry for faster wire insertion and lower installed cost

Insulation grip sleeve provides a superior insulation crimp for high vibration and high strain relief applications



*UL and CSA rated up to 300V

Vinyl Barrel Insulated Funnel Entry, Female Receptacles and Male Tabs Type DV

Available in tab sizes to accommodate .187", .205" or .250" tabs

Continuously molded design provides reliable, consistent performance through applicator

Insulation grip sleeve provides a superior insulation crimp for high vibration and high strain relief applications

Insulation support to protect electrical crimp



*UL and CSA Rated up to 600V

Features and Benefits — REEL SMART™ Disconnects

Applicable REEL SMART™ products meet or exceed the following test specifications:

- Listed per Underwriters Laboratories, Inc. Standard UL 310 (Disconnects)
- Recognized under the Component Recognition Program of Underwriters Laboratories Inc.
- Certified by Canadian Standards Association (Disconnects)
- UL and CSA listed products are shown with the applicable logos in the product section.
- UL file #E78522. CSA file #LR31212.

Performance Requirements

	Wire Size (AWG)						
	#22	#20	#18	#16	#14	#12	#10
UL310 (DISCONNECTS)							
Continuous Test Current for Max. 30°C Rise (Amps) (for .187", .205", .250" tab widths)	3	4	7	10	15	20	24
Continuous Test Current for Max. 30°C Rise (Amps) (for .110" tab width)	2	3	4	5	Not Applicable		
Min. Tensile Strength* (Lbs.)	8	13	20	30	50	70	80

*Pull-out force of the crimped disconnect

Part Number System for REEL SMART™ Disconnects

D	NF	14	—	250	FIB	3K
Type:	Insulation	Wire Range	Size & Type	Special Configuration	Std. Pkg. Size	
D = Disconnects	NF = Nylon Funnel Entry NG = Nylon Funnel Entry Metal Insulation Grip NFR = Nylon Funnel Entry Right Angle PF = Premium Grade Nylon (Double Crimp) V = Vinyl	18 = #22 - 18 14 = #16 - 14 10 = #12 - 10	110 = .110 x .032 Tab Size 111 = .110 x .020 Tab Size 145 = .145 x .032 Tab Size 187 = .187 x .032 Tab Size 188 = .187 x .020 Tab Size 205 = .187/.205 x .032 Tab Size 206 = .187/.205 x .020 Tab Size 250 = .250 x .032 Tab Size .187/.205: Expandable receptacle will accept male tabs from .187" to .205" widths in .032" or .020" thick styles. Fully reliable connection through all widths.	B = Butted Seam C = Compression Tab FB = Metal Insulation Grip, Female FL = Fully Insulated Positive Locking Female FIB = Fully Insulated, Butted Seam, Female FIBX = Fully Insulated, Butted Seam, Female, Expanded Wire Entry FIM = Fully Insulated Male FIMB = Fully Insulated, Male, Oversized Housing FIMX = Fully Insulated, Male, Expanded Wire Entry M = Male MB = Male Butted Seam	K = 1,000 KD = 1,500 2K = 2,000 3K = 3,000	

System Overview

Terminals

Disconnects

Splices

Ferrules

Compression Connectors

Crimping Tools

Mechanical Connectors

Grounding Connectors

Support Products

Technical Info

Index

System Overview



SUPRA-GRIP™ Female Disconnects, Nylon Fully Insulated

Terminals

- Type DNG-FB**
- Integrated metal insulation grip
 - Funnel entry

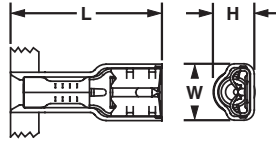

Disconnects

Part Number	Wire Range	Color Code	Max. Ins.	Figure Dimensions (In.)			Tab Size		CA9 Series Crimp Die	CA-800 Series Crimp Die	Pieces Per Reel
				L	W	H	In.	mm			
DNG18-187FB-3K	22-18 AWG	Red	.128	.89	.29	.22	.187 x .032	4.7 x .8	CD9-15A	CD-800-15	3000
DNG18-188FB-3K				.89	.29	.22	.187 x .020	4.7 x .5			3000
DNG18-250FB-3K				.94	.35	.23	.250 x .032	6.3 x .8			3000
DNG14-187FB-3K	16-14 AWG	Blue	.155	.89	.29	.25	.187 x .032	4.7 x .8	CD9-16A	CD-800-16	3000
DNG14-188FB-3K				.89	.29	.25	.187 x .020	4.7 x .5			3000
DNG14-250FB-3K				.94	.35	.26	.250 x .032	6.3 x .8			3000

Ferrules



DISCO-LOK™ Female Disconnects, Nylon Fully Insulated

Compression Connectors

- Type DNG-FL**
- Positive locking mechanism
 - Integrated metal insulation grip
 - Funnel entry

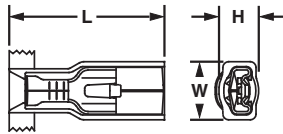

Crimping Tools

Part Number	Wire Range	Color Code	Max. Ins.	Figure Dimensions (In.)			Tab Size		CA9 Series Crimp Die	CA-800 Series Crimp Die	Pieces Per Reel
				L	W	H	In.	mm			
DNG18-250FL-3K	22-18 AWG	Red	.126	.97	.36	.25	.250 x .032	6.3 x .8	CD9-14A	CD-800-14	3000
DNG14-250FL-3K	16-14 AWG	Blue	.150	.97	.36	.25	.250 x .032	6.3 x .8	CD9-14A	CD-800-14	3000

Mechanical Connectors

Grounding Connectors

Support Products

Technical Info

Index



Female Disconnects, Nylon Fully Insulated

Type DNF-FIB

- Funnel entry
- Insulation support
- Internal wire stop

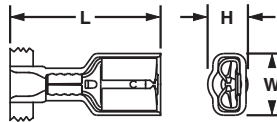

Part Number	Wire Range	Color Code	Max. Ins.	Figure Dimensions (In.)			Tab Size		CA9 Series Crimp Die	CA-800 Series Crimp Die	Pieces Per Reel
				L	W	H	In.	mm			
DNF18-110FIB-3K	22-18 AWG	Red	.120	.71	.19	.15	.110 x .032	2.8 x .8	CD9-7A	CD-800-7	3000
DNF18-111FIB-3K		Red	.120	.71	.19	.15	.110 x .020	2.8 x .5	CD9-7A	CD-800-7	3000
DNF18-112FIB-3K*		Natural	.120	.71	.19	.15	.110 x .010	2.8 x .3	CD9-7A	CD-800-7	3000
DNF18-187FIB-3K		Red	.136	.78	.29	.16	.187 x .032	4.8 x .8	CD9-4A	CD-800-4	3000
DNF18-188FIB-3K		Red	.136	.78	.29	.16	.187 x .020	4.8 x .5	CD9-4A	CD-800-4	3000
DNF18-205FIB-3K		Red	.136	.78	.31	.22	.187/.205 x .032	4.8/5.2 x .8	CD9-4A	CD-800-4	3000
DNF18-206FIB-3K		Red	.136	.78	.31	.22	.187/.205 x .020	4.8/5.2 x .5	CD9-4A	CD-800-4	3000
DNF18-250FIB-3K**		Red	.136	.84	.35	.22	.250 x .032	6.3 x .8	CD9-4A	CD-800-4	3000
DNF14-187FIB-3K	16-14 AWG	Blue	.160	.78	.29	.18	.187 x .032	4.8 x .8	CD9-5A	CD-800-5	3000
DNF14-188FIB-3K			.160	.78	.29	.18	.187 x .020	4.8 x .5	CD9-5A	CD-800-5	3000
DNF14-205FIB-3K			.160	.78	.31	.22	.187/.205 x .032	4.8/5.2 x .8	CD9-5A	CD-800-5	3000
DNF14-206FIB-3K			.160	.78	.31	.22	.187/.205 x .020	4.8/5.2 x .5	CD9-5A	CD-800-5	3000
DNF14-250FIB-3K			.160	.84	.35	.22	.250 x .032	6.3 x .8	CD9-5A	CD-800-5	3000
DNF10-250FIB-2K	12-10 AWG	Yellow	.220	.96	.35	.23	.250 x .032	6.3 x .8	CD9-13B	CD-800-13	2000
DNF10250FIBC-2K*			.220	.96	.35	.23	.250 x .032	6.4 x .8	CD9-13B	CD-800-13	2000

*UL/CSA standards do not exist for .110" x .010" receptacles.

**UL with 17 AWG wire.



Disco™ Female Disconnects, Nylon Fully Insulated — Expanded Wire Entry

Type DNF-FIBX

- Funnel entry
- Insulation support
- Internal wire stop
- Expanded wire entry area for large wire insulation O.D.

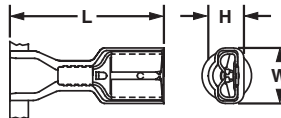

Part Number	Wire Range	Color Code	Max. Ins.	Figure Dimensions (In.)			Tab Size	Tab Size	CA9 Series Crimp Die	CA-800 Series Crimp Die	Pieces Per Reel
				L	W	H	In.	mm			
DNF18205FIBX-2K	22-18 AWG	Red	.210	.87	.31	.22	.187/.205 x .032	4.8/5.2 x .8	CD9-6B	CD-800-6	2000
DNF18206FIBX-2K				.87	.31	.22	.187/.205 x .020	4.8/5.2 x .5			2000
DNF18250FIBX-2K				.93	.35	.22	.250 x .032	6.3 x .8			2000
DNF14205FIBX-2K	16-14 AWG	Blue	.240	.87	.31	.22	.187/.205 x .032	4.8/5.2 x .8	CD9-8B	CD-800-8	2000
DNF14206FIBX-2K				.87	.31	.22	.187/.205 x .020	4.8/5.2 x .5			2000
DNF14250FIBX-2K				.93	.35	.22	.250 x .032	6.3 x .8			2000

System Overview



Disco™ Female Disconnects, Nylon Fully Insulated — Right Angle

Terminals

Type DNFR-FIB

- Funnel entry
- Insulation support

Disconnects

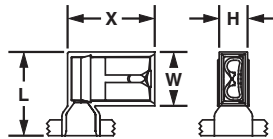

Splices

Part Number	Wire Range	Color Code	Max. Ins.	Figure Dimensions (In.)				Tab Size		CA9 Series Crimp Die	CA-800 Series Crimp Die	Pieces Per Reel
				L	W	H	X	In.	mm			
DNFR18205FIB-KD	22-18 AWG	Red	.178	.57	.37	.21	.60	.187/.205 x .032	4.8/5.2 x .8	CD9-9C	CD-800-9	1500
DNFR18206FIB-KD				.57	.37	.21	.60	.187/.205 x .020	4.8/5.2 x .5			1500
DNFR18250FIB-KD				.57	.37	.21	.60	.250 x .032	6.3 x .8			1500
DNFR14205FIB-KD	16-14 AWG	Blue		.57	.37	.21	.60	.187/.205 x .032	4.8/5.2 x .8			1500
DNFR14206FIB-KD				.57	.37	.21	.60	.187/.205 x .020	4.8/5.2 x .5			1500
DNFR14250FIB-KD				.57	.37	.21	.60	.250 x .032	6.3 x .8			1500

Ferrules

Compression Connectors



Disco™ Female Disconnects, Vinyl Barrel Insulated

Type DV-B

- Funnel entry
- Insulation support
- Internal wire stop

Crimping Tools

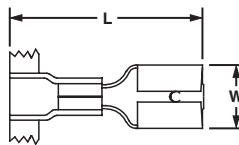

Mechanical Connectors

Part Number	Wire Range	Color Code	Max. Ins.	Figure Dimensions (In.)		Tab Size		CA9 Series Crimp Die	CA-800 Series Crimp Die	Pieces Per Reel
				L	W	In.	mm			
DV18-187B-3K	22-18 AWG	Red	.160	.77	.23	.187 x .032	4.8 x .8	CD9-1A	CD-800-1	3000
DV18-188B-3K			.160	.77	.23	.187 x .020	4.8 x .5			3000
DV18-205B-3K			.160	.77	.25	.187/.205 x .032	4.8/5.2 x .8			3000
DV18-206B-3K			.160	.77	.25	.187/.205 x .020	4.8/5.2 x .5			3000
DV18-250B-3K			.160	.83	.29	.250 x .032	6.3 x .8			3000
DV14-187B-3K	16-14 AWG	Blue	.170	.77	.23	.187 x .032	4.8 x .8	CD9-2A	CD-800-2	3000
DV14-188B-3K			.170	.77	.23	.187 x .020	4.8 x .5			3000
DV14-205B-3K			.178	.77	.25	.187/.205 x .032	4.8/5.2 x .8			3000
DV14-206B-3K			.178	.77	.25	.187/.205 x .020	4.5/5.2 x .5			3000
DV14-250B-3K	12-10 AWG	Yellow	.178	.83	.29	.250 x .032	6.3 x .8	CD9-3B	CD-800-3	3000
DV10-250-2K*			.230	.95	.29	.250 x .032	6.3 x .8			2000
DV10-250C-2K†**			.220	.95	.29	.250 x .032	6.4 x .8			2000

*DV10-250-2K is not UL Listed or CSA Certified.
 **DV10-250C-2K is UL Recognized and CSA Certified.
 †Compression tab disconnect to fit .250" tabs with a post style support.

Technical Info

Index



DISCOGRIP[™] Female Disconnects, Fully Insulated

Type DPF-FIB

- Premium grade nylon housing
- Standard receptacle housings
- For applications experiencing high vibration or conductor strain

- Funnel entry
- Internal wire stop

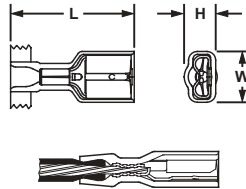

Cross section of *DiscoGrip*[™] crimp showing insulation crimp of the wire insulation.

Part Number	Wire Range	Color Code	Max. Ins.	Figure Dimensions (In.)			Tab Size		CA9 Series Crimp Die	CA-800 Series Crimp Die	Pieces Per Reel
				L	W	H	In.	mm			
DPF18-110FIB-3K	22-18 AWG	Red	.132	.71	.19	.17	.110 x .032	2.8 x .8	CD9-12A	CD-800-12	3000
DPF18-111FIB-3K			.132	.71	.19	.17	.110 x .020	2.8 x .5			3000
DPF18-187FIB-3K			.136	.78	.29	.16	.187 x .032	4.8 x .8			3000
DPF18-188FIB-3K			.136	.78	.29	.16	.187 x .020	4.8 x .5	CD9-10A	CD-800-10	3000
DPF18-205FIB-3K			.136	.78	.31	.22	.187/.205 x .032	4.8/5.2 x .8			3000
DPF18-206FIB-3K			.136	.78	.31	.22	.187/.205 x .020	4.8/5.2 x .5			3000
DPF18-250FIB-3K			.136	.84	.35	.22	.250 x .032	6.3 x .8			3000
DPF14-187FIB-3K	16-14 AWG	Blue	.160	.78	.29	.18	.187 x .032	4.8 x .8	CD9-11A	CD-800-11	3000
DPF14-205FIB-3K			.160	.78	.31	.22	.187/.205 x .032	4.8/5.2 x .8			3000
DPF14-206FIB-3K			.160	.78	.31	.22	.187/.205 x .020	4.8/5.2 x .5			3000
DPF14-250FIB-3K			.160	.84	.35	.22	.250 x .032	6.3 x .8			3000
DPF10-250FIB-2K	12-10 AWG	Yellow	.220	.96	.35	.23	.250 x .032	6.3 x .8	CD9-13B	CD-800-13	2000



DISCOGRIP[™] Male Disconnects, Fully Insulated

Type DPF-FIM

- Premium grade nylon housing
- Funnel entry
- Internal wire stop

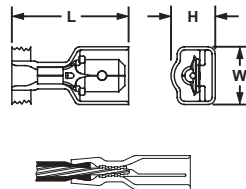

Cross section of *DiscoGrip*[™] crimp showing insulation crimp of the wire insulation.

Part Number	Wire Range	Color Code	Max. Ins.	Figure Dimensions (In.)			Tab Size		CA9 Series Crimp Die	CA-800 Series Crimp Die	Pieces Per Reel
				L	W	H	In.	mm			
Standard Housing											
DPF18-250FIM-2K	22-18 AWG	Red	.133	.90	.41	.29	.250 x .032	6.3 x .8	CD9-10B	CD-800-10	2000
DPF14-250FIM-2K	16-14 AWG	Blue	.156				CD9-11B	CD-800-11	2000		
Oversized Housing											
DPF18-250FIMB-K*	22-18 AWG	Red	.133	.92	.46	.34	.250 x .032	6.3 x .8	CD9-10B	CD-800-10	1000
DPF14-250FIMB-K*	16-14 AWG	Blue	.156				CD9-11B	CD-800-11	1000		

*To mate with other manufacturers fully insulated .250 x .032 female receptacles.

System Overview

Terminals

Disconnects

Splices

Ferrules

Compression Connectors

Crimping Tools

Mechanical Connectors

Grounding Connectors

Support Products

Technical Info

Index

System Overview

UL LISTED **SP CERTIFIED** **Disco™ Male Disconnects, Nylon Fully Insulated**

Terminals

Type DNF-FIM

- Funnel entry
- Insulation support
- Internal wire stop

Disconnects

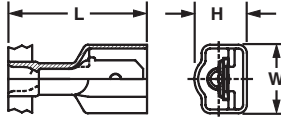

Splices

Part Number	Wire Range	Color Code	Max. Ins.	Figure Dimensions (In.)			Tab Size		CA9 Series Crimp Die	CA-800 Series Crimp Die	Pieces Per Reel
				L	W	H	In.	mm			
Standard Housing											
DNF18-250FIM-2K	22-18 AWG	Red	.133	.90	.42	.30	.250 x .032	6.3 x .8	CD9-4B	CD-800-4	2000
DNF14-250FIM-2K	16-14 AWG	Blue	.158	.90	.42	.30	.250 x .032	6.3 x .8	CD9-5B	CD-800-5	2000
Oversized Housing											
DNF18-250FIMB-K*	22-18 AWG	Red	.135	.91	.45	.34	.250 x .032	6.3 x .8	CD9-4B	CD-800-4	1000
DNF14-250FIMB-K*	16-14 AWG	Blue	.160	.91	.46	.33	.250 x .032	6.3 x .8	CD9-5B	CD-800-5	1000
DNF10-250FIMB-K	12-10 AWG	Yellow	.220	.96	.45	.36	.250 x .032	6.3 x .8	CD9-18B	CD-800-18	1000

*To mate with other manufacturers' fully insulated, .250 x .032 female receptacles.

Crimping Tools

UL LISTED **SP CERTIFIED** **Disco™ Male Disconnects, Nylon Fully Insulated — Expanded Wire Entry**

Type DNF-FIMX

- Standard receptacle housings
- Funnel entry
- Insulation support
- Internal wire stop
- Expanded wire – entry area for large wire insulation O.D. and dual wire applications

Mechanical Connectors

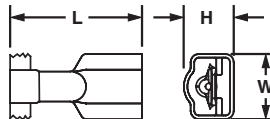

Grounding Connectors

Part Number	Wire Range	Color Code	Max. Ins.	Figure Dimensions (In.)			Tab Size		CA9 Series Crimp Die	CA-800 Series Crimp Die	Pieces Per Reel
				L	W	H	In.	mm			
Standard Housing – Expanded Wire Entry Area											
DNF18250FIMX-2K*	22-18 AWG	Red	.244	.97	.41	.29	.250 x .032	6.3 x .8	CD9-8B	CD-800-8	2000
DNF14250FIMX-2K**	16-14 AWG	Blue									2000

*CSA Certified for use with (2) #18 AWG, (2) #20 AWG or (2) #22 AWG wires.

**CSA Certified for use with (2) #16 AWG or (2) #18 AWG wires.

Technical Info

Index

UL CERTIFIED **Disco™ Male Disconnects, Nylon Barrel Insulated**

Type DNF-M

- Funnel entry
- Internal wire stop

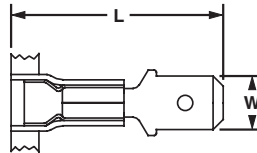

Part Number	Wire Range	Color Code	Max. Ins.	Figure Dimensions (In.)		Tab Size		CA9 Series Crimp Die	CA-800 Series Crimp Die	Pieces Per Reel
				L	W	In.	mm			
Nylon Insulated – Metal Insulation Grip Sleeve										
DNF18-250M-3K	22-18 AWG	Red	.145	.90	.25	.250 x .032	6.3 x .8	CD9-1A	CD-800-1	3000
DNF14-250M-3K	16-14 AWG	Blue	.162	.90	.25	.250 x .032	6.3 x .8	CD9-2A	CD-800-2	3000
DNF10-250M-2K*	12-10 AWG	Yellow	.225	.95	.25	.250 x .032	6.3 x .8	CD9-3B	CD-800-3	2000

*Not CSA Certified.

UL LISTED **UL CERTIFIED** **Disco™ Male Disconnects, Vinyl Barrel Insulated**

Type DV-MB

- Funnel entry
- Internal wire stop

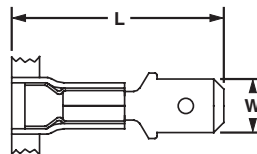

Part Number	Wire Range	Color Code	Max. Ins.	Figure Dimensions (In.)		Tab Size		CA9 Series Crimp Die	CA-800 Series Crimp Die	Pieces Per Reel
				L	W	In.	mm			
Vinyl Insulated – Plastic Insulation Crimp										
DV18-250MB-3K	22-18 AWG	Red	.155	.90	.25	.250 x .032	6.3 x .8	CD9-1A	CD800-1	3000
DV14-250MB-3K	16-14 AWG	Blue	.175					CD9-2A	CD-800-2	3000
DV10-250M-2K	12-10 AWG	Yellow	.225					CD9-3B	CD-800-3	2000

System Overview

Terminals

Disconnects

Splices

Ferrules

Compression Connectors

Crimping Tools

Mechanical Connectors

Grounding Connectors

Support Products

Technical Info

Index

System Overview

REEL SMART™ Tooling**

Terminals



Disconnects



Splices



Ferrules

Part Number	Part Description	Std. Pkg. Qty.
CA-800	Applicator: used in CP-861 electric press and uses CD-800 series die inserts.	1
CA-800EZ*	Applicator: runs in the AMP* Model T and K bench presses. True "quick change" applicator — no additional plates are necessary. Slide right into the press for easy changeover. Uses CD-800 Series Die inserts.	1
CA9	CA9 <i>EZAIR</i> ™ Applicator: terminates the entire <i>REEL SMART</i> ™ product line. This greatly reduces set up and maintenance time and increases productivity. This patented applicator is so smart it automatically adjusts feed stroke to the correct pitch and length for the entire product line. Crimp die changeover in less than 1 minute, minimizes down-time and increases productivity. Fast, easy loading of terminal parts without special instructions or set-up personnel. Simply feed the parts strip into the applicator. All the necessary adjustments are made by the dies and the automatic feed stroke. Used in CP-862 electric press. Safety lockout guard ensures operator safety. Positive stop adjustment rings allow for electrical and insulation crimp adjustments as desired. Designed for use in wire processing machines manufactured by Komax, AMP, ShinMaywa, Artos and Megomat. Uses CD9 Series Die inserts.	1

*AMP is a registered trademark of Tyco Electronics.

**For crimp die information, refer to [pages K23 to K24](#).

Compression Connectors

Electric Flywheel Presses

Crimping Tools



Mechanical Connectors



Grounding Connectors

Part Number	Part Description	Std. Pkg. Qty.
CP-861*	Electric flywheel press: 4000+ terminations per hour Operates on 120 AC current Resettable counter Overall size (with reel): width: 33" depth: 19" height: 41" Total weight (without reel): 205 lbs. Includes foot switch.	1
CP-862*	Electric flywheel press: 4000+ terminations per hour Operates on 115 VAC current Overall size (with reel): width: 33" depth: 19" height: 41" Total weight (without reel): 205 lbs. Includes foot switch	1

*Applicator shown, sold separately.

Support Products

Die Sharpening Kits

- Used to resharpen cutting edges and maintain reliability of CD-800 and CD9 series cutter dies

Technical Info

Part Number	Part Description	Std. Pkg. Qty.
DSF-RS	For use with black oxide cutter dies.	1
DSF-NP	For use with nickel-plated cutter dies.	1

Index

Die Information Chart

Part Number	AWG Wire Range	Color Code	Wire Insulation Strain Relief	Part No. Prefix	60/40 Solder Slug Dia.		Spare Part Number				
					In.	mm	Crimp Die	Cutter Die	Lower Die		
CD-800-1	22 – 18 22 – 16 22 – 18 22 – 16	Red	Plastic Ins. Crimp / Insulation Support / Metal Ins. Crimp / Plastic Ins. Crimp	PV, DV-MB, DV-B / BSN / PN, PNF, DNF-M / BSP (Premium Nylon)	.188	4.78	TD13471C06 CD-800 -1	TD13483C02 CD-800 C1	TD17755B01 CD-1		
CD-800-1D***	22 – 18										
CD-800-2	16 – 14 18 – 14 16 – 14 18 – 14	Blue	Plastic Ins. Crimp / Insulation Support / Metal Ins. Crimp / Plastic Ins. Crimp	PV, DV-MB, DV-B / BSN / PN, PNF, DNF-M / BSP (Premium Nylon)			TD13473C05 CD-800 -2	TD13486C03 CD-800 C-2	TD17756B01 C-2		
CD-800-2D***	16 – 14										
CD-800-3	12 – 10 14 – 10 16 – 12 16 – 12 12 – 10	Yellow	Plastic Ins. Crimp / Plastic Ins. Crimp / Metal Ins. Crimp / Plastic Ins. Crimp / Metal Ins. Crimp	PV, PV12, DV / DV-C / PN12 / PV12 / DV-M, PN, PNF, DNF-M			TD13475C06 CD-800 -3	TD13489C02 CD-800 C-3	TD17757B01 C-3		
CD-800-4	12 – 18	Red	Insulation Support	DNF-FIB, DNF-FIM, DNF-FIMB, DNF-LPB							
CD-800-5	16 – 14	Blue	Insulation Support	DNF-FIB, DNF-FIM, DNF-FIMB, DNF-LPB			TD13634C05 CD-800 -5, 11	TD13508C02 CD-800 C-5	TD17759B01 C-5, 11		
CD-800-6	22 – 18	Red	Insulation Support	DNF-FIBX							
CD-800-7	22 – 18	Red	Insulation Support	DNF-110FIB, DNF-111FIB, DNF-112FIB			.125	3.18	TD13477C05 CD-800 -7, 12	TD13492C03 CD-800 C-7	TD17761B01 C-7, 12
CD-800-8	16 – 14 22 – 18 16 – 14	Blue / Red / Blue	Insulation Support	DNF-FIBX / DNF-FIMX / DNF-FIMX			.188	4.78	TD13481C06 CD-800 -8	TD13502C03 CD-800 C-8	TD17762B01 C-8
CD-800-9	22 – 14	Red / Blue	Insulation Support	DNFR-FIB	.125	3.18	TD13479C05 CD-800 -9	TD13495C02 CD-800 C-9	TD17763B01 C-9		
CD-800-10	22 – 18	Red	<i>DiscoGRIP</i> [™] Insulation Crimp	DPF-FIB, DPF-FIM, DPF-FIMB, DPF-LPB	.188	4.78	TD13633C06 CD-800 -4, 10	TD16233C02 CD-800 C-10	TD17758B01 C-4, 10		
CD-800-11	16 – 14	Blue	<i>DiscoGRIP</i> [™] Insulation Crimp	DPF-FIM, DPF-FIMB / DPF-FIB, DPF-LPB							
CD-800-12	22 – 18	Red	<i>DiscoGRIP</i> [™] Insulation Crimp	DPF-110FIB, DPF-111FIB	.125	3.18	TD13477C05 CD-800 -7, 12	TD16235C02 CD-800 C-12	TD17761B01 C-7, 12		
CD-800-13	12 – 10	Yellow	Insulation Support / <i>DiscoGRIP</i> [™] Insulation Crimp	DNF-FIB / DPF-FIB	.188	4.78	TD19116C03 CD-800 -13	TD19115C05 CD-800 C-13	TD19424B01 C-13		
CD-800-14	22 – 18 16 – 14	Red / Blue	Metal Insulation Crimp	DNG-FL	.125	3.18	TD22943C01 CD-800 -14	TD22944C01 CD-800 C-14	TD22960B01 C-14		
CD-800-15	22 – 18	Red	Metal Insulation Crimp	DNG-FB	.188	4.78	TD22945C01 CD-800 -15	TD22946C01 CD-800 C-15	TD22961B01 C-15		
CD-800-16	16 – 14	Blue	Metal Insulation Crimp	DNG-FB			TD22947C01 CD-800 -16	TD22948C01 CD-800 C-16	TD22962B01 C-16		
CD-800-17	12 – 10	Yellow	Insulation Support	BSN			TD23601C01 CD-800-17	TD23600C01 CD-800-17	TD23612B01 CD-800-17		
CD-800-18	12 – 10	Yellow	Plastic Insulation Crimp	DNF-FIMB	TD13475C06 CD-800-18	TD23773C01 CD-800-18	TD17757B01 CD-800-18				

TA13721A01 = 60/40 Solder Slug with 1/8" (.125) outer diameter.

TA13722A01 = 60/40 Solder Slug with 3/16" (.188) outer diameter.

(1) Insulation Support: Minimum wire insulation strain relief for normal applications.

Plastic & *DiscoGRIP*[™] insulation Crimp: Secondary wire insulation strain relief for high vibration or conductor strain applications.

Metal Insulation Grip: Maximum wire insulation strain relief for high vibration or conductor strain applications.

***Modified lower die for barrel insulated disconnects DV-B series. Available as a complete die set or just lower die assembly.

System
Overview

Terminals

Disconnects

Splices

Ferrules

Compression
Connectors

Crimping
Tools

Mechanical
Connectors

Grounding
Connectors

Support
Products

Technical
Info

Index

System Overview

Die Information Chart (continued)

Terminals	Part Number	Color Code	AWG Wire Range	Wire Insulation Strain Relief	Part No. Prefix	60/40 Solder Slug Dia.		Spare Part Number		
						In.	mm	Crimp Die	Cutter Die	Lower Die
Disconnects	CD9-1A	Red	22 – 16 22 – 16 22 – 18 22 – 18	Insulation Support / Plastic Ins. Crimp / Plastic Ins. Crimp / Metal Ins. Grip	BSN / BSP / PV, DV-B, DV-MB / PN, PNF, DNF-M	.188	4.78	TD24129C01	TD24139C01	TD24149C01
	CD9-1AD***		22 – 18	Plastic Insulation Crimp Metal Insulation Grip	PV, DV-B, DV-MB, PN, PNF, DNF-M	.188	4.78			
	CD9-1B		22 – 18	Plastic Insulation Crimp	PV-56R, PV-38R	.188	4.78			
Splices	CD9-2A	Blue	18 – 14 18 – 14 16 – 14 16 – 14 16 – 14	Insulation Support / Plastic Ins. Crimp / Insulation Support / Plastic Ins. Crimp / Metal Ins. Grip	BSN / BSP / BSN / PV, DV-B, DV-MB / PN, PNF, DNF-M	.188	4.78	TD24130C01	TD24140C01	TD23712C01
	CD9-2AD***		16 – 14	Insulation Support Plastic Insulation Crimp Metal Insulation Grip	BSN, PV, DV-B, DV-MB, PN, PNF, DNF-M	.188	4.78			
Ferrules	CD9-2B	Yellow	16 – 14	Plastic Insulation Crimp	PV-56R, PV-38R	.188	4.78	TD24131C01	TD24141C01	TD23713C01
Compression Connectors	CD9-3B		12 – 10 12 – 10 16 – 12	Plastic Ins. Crimp / Metal Ins. Grip / Plastic Ins. Crimp	PV, DV, DV-M / PN, PNF, DNF-M / PV12, PN12	.188	4.78			
	CD9-4A		22 – 18	Insulation Support	DNF-FIB, DNF-LPB	.188	4.78			
CD9-4B	22 – 18	Insulation Support	DNF-FIM, DNF-FIMB	.188	4.78					
Crimping Tools	CD9-5A	Blue	16 – 14	Insulation Support	DNF-FIB, DNF-LPB	.188	4.78	TD24133C01	TD24143C01	TD24151C01
	CD9-5B		16 – 14	Insulation Support	DNF-FIM, DNF-FIMB	.188	4.78			
Mechanical Connectors	CD9-6B	Red	22 – 18	Insulation Support	DNF-FIBX	.188	4.78	TD23700C01	TD23683C01	TD23716C01
	CD9-7A	Red	22 – 18	Insulation Support	DNF-110/111/112FIB	.125	3.18	TD23701C02	TD23684C01	TD23717C01
	CD9-8B	Blue / Red / Blue	16 – 14 22 – 14	Insulation Support / Insulation Support	DNF-FIBX / DNF-FIMX	.188	4.78	TD23702C01	TD23685C01	TD23718C01
Grounding Connectors	CD9-9C	Red / Blue	22 – 14	Insulation Support	DNFR-FIB	.125	3.18	TD23703C01	TD23686C01	TD23719C01
	CD9-10A	Red	22 – 18	<i>DISCOGRIP</i> [™] Insulation Crimp	DPF-FIB, DPF-LPB	.188	4.78	TD24132C01	TD24144C01	TD24150C01
	CD9-10B	Red	22 – 18	<i>DISCOGRIP</i> [™] Insulation Crimp	DPF-FIM, DPF-FIMB	.188	4.78			
Support Products	CD9-11A	Blue	16 – 14	<i>DISCOGRIP</i> [™] Insulation Crimp	DPF-FIB, DPF-LPB	.188	4.78	TD24133C01	TD23688C01	TD24151C01
	CD9-11B	Blue	16 – 14	<i>DISCOGRIP</i> [™] Insulation Crimp	DPF-FIM, DPF-FIMB	.188	4.78			
	CD9-12A	Red	22 – 18	<i>DISCOGRIP</i> [™] Insulation Crimp	DPF-110FIB, DFP-111FIB	.125	3.18	TD23701C02	TD23689C01	TD23717C01
Technical Info	CD9-13B	Yellow	12 – 10	Insulation Support / <i>DISCOGRIP</i> [™] Insulation Crimp	DNF-FIB / DPF-FIB	.188	4.78	TD24134C01	TD24145C01	TD24152C01
	CD9-14A	Red / Blue	22 – 18 16 – 14	Metal Insulation Grip	DNG-FL	.125	3.18	TD23705C01	TD23691C01	TD23721C01
	CD9-15A	Red	22 – 18	Metal Insulation Grip	DNG-FB	.188	4.78	TD24135C01	TD24146C01	TD24153C01
Index	CD9-16A	Blue	16 – 14	Metal Insulation Grip	DNG-FB	.188	4.78	TD24136C01	TD24147C01	TD24154C01
	CD9-17B	Yellow	12 – 10	Insulation Support	BSN	.188	4.78	TD24110C01	TD24109C01	TD24111C01 TD24112C01
	CD9-18B	Yellow	12 – 10	Insulation Support	DNF-FIMB	.188	4.78	TD24131C01	TD23766C01	TD23713C01

TA13721A01 = 60/40 Solder Slug with 1/8" (.125) outer diameter.

TA13722A01 = 60/40 Solder Slug with 3/16" (.188) outer diameter.

(1) Insulation Support: Minimum wire insulation strain relief for normal applications.

Plastic & *DISCOGRIP*[™] Insulation Crimp: Secondary wire insulation strain relief for high vibration or conductor strain applications.

Metal Insulation Grip: Maximum wire insulation strain relief for high vibration or conductor strain applications.

***Modified lower die for barrel insulated disconnects DV-B series. Available as a complete die set or just lower die assembly.

Heat Shrink



Thin Wall Polyolefin Heat Shrink



- Shrink ratio of 2:1 insulates a wide range of diameters and irregular shapes
- Cross-linked, UV resistant material improves flame retardancy, chemical and temperature resistance

Part Number	Material	Color	Length		Max. Recovered I.D.		Min. Expanded I.D.		Nominal Diameter / Size	Nominal Recovered Wall Thickness		Temperature Range	Std. Pkg. Qty.
			ft.	M	In.	mm	In.	mm		In.	mm		

Thin Wall Heat Shrink

HSTT05-48-Q	Flame retardant polyolefin cross-linked except clear [^]	Black [‡]	4	1.2	.02	.5	.05	1.3	3/64	.023	.4	-67°F to 275°F (-55°C to 135°C)	25
HSTT06-48-Q			4	1.2	.03	.8	.06	1.5	1/16	.017	.4		25
HSTT09-48-Q			4	1.2	.05	1.3	.09	2.3	3/32	.020	.5		25
HSTT12-48-Q			4	1.2	.06	1.5	.13	3.3	1/8	.020	.5		25
HSTT19-48-Q			4	1.2	.09	2.3	.19	4.8	3/16	.020	.5		25
HSTT25-48-Q			4	1.2	.13	3.3	.25	6.4	1/4	.025	.6		25
HSTT38-48-Q			4	1.2	.19	4.8	.38	9.7	3/8	.025	.6		25
HSTT50-48-Q			4	1.2	.25	6.4	.50	12.7	1/2	.025	.6		25
HSTT75-48-5			4	1.2	.38	9.7	.75	19.1	3/4	.030	.8		5
HSTT100-48-5			4	1.2	.50	12.7	1.00	25.4	1	.035	.9		5
HSTT150-48-5			4	1.2	.75	19.1	1.50	38.1	1 1/2	.040	1.0		5
HSTT200-48-5			4	1.2	1.00	25.4	2.00	50.8	2	.045	1.1		5
HSTT300-48-2			4	1.2	1.50	38.1	3.00	76.2	3	.050	1.3		2
HSTT400-48-2			4	1.2	2.00	50.8	4.00	101.6	4	.055	1.4		2

Thin Wall VW-1 Rated Heat Shrink

HSTTV05-48-Q	Highly flame retardant polyolefin cross-linked ^{^^}	Black	4	1.2	.02	.5	.05	1.3	3/64	.016	.4	-67°F to 257°F (-55°C to 125°C)	25
HSTTV06-48-Q			4	1.2	.03	.8	.06	1.5	1/16	.017	.4		25
HSTTV09-48-Q			4	1.2	.05	1.3	.09	2.3	3/32	.020	.5		25
HSTTV12-48-Q			4	1.2	.06	1.5	.13	3.3	1/8	.020	.5		25
HSTTV19-48-Q			4	1.2	.09	2.3	.19	4.8	3/16	.020	.5		25
HSTTV25-48-Q			4	1.2	.13	3.3	.25	6.4	1/4	.025	.6		25
HSTTV38-48-Q			4	1.2	.19	4.8	.38	9.7	3/8	.025	.6		25
HSTTV50-48-Q			4	1.2	.25	6.4	.50	12.7	1/2	.025	.6		25
HSTTV75-48-5			4	1.2	.38	9.7	.75	19.1	3/4	.030	.8		5
HSTTV100-48-5			4	1.2	.50	12.7	1.00	25.4	1	.035	.9		5
HSTTV150-48-5			4	1.2	.75	19.1	1.50	38.1	1 1/2	.040	1.0		5

[‡]For clear, add "C" to end of part number package suffix (Example HSTT05-48-QC). Contact customer service for additional color information.

[^]Meets Mil Spec AMS-DTL-23053/5 Class 1, except clear which is manufactured from non-flame retardant polyolefin cross-linked material and meets AMS-DTL-23053/5 Class 2.

^{^^}Meets Mil Spec AMS-DTL-23053/5 Class 3.

System Overview

Terminals

Disconnects

Splices

Ferrules

Compression Connectors

Crimping Tools

Mechanical Connectors

Grounding Connectors

Support Products

Technical Info

Index

PANDUIT® TERMINATION SOLUTIONS

System Overview



Thin Wall Polyolefin Heat Shrink — Convenience Packs

Terminals



- Small package fits easily in tool box
- Shrink ratio of 2:1 insulates a wide range of diameters and irregular shapes
- Cross-linked, UV resistant material improves flame retardancy, chemical and temperature resistance

Disconnects

Splices

Part Number	Material	Color	Length		Max. Recovered I.D.		Min. Expanded I.D.		Nominal Diameter/ Size	Nominal Recovered Wall Thickness		Temperature Range	Std. Pkg. Qty.
			In.	mm	In.	mm	In.	mm		In.	mm		

Black Only — Single Diameter — VW-1 Rated Heat Shrink

HSTTV06-Y	Highly flame retardant polyolefin cross-linked ^{^^}	Black	6.00	152.4	.03	.8	.06	1.5	1/16	.017	.4	-67°F to 257°F (-55°C to 125°C)	1
HSTTV09-Y			6.00	152.4	.05	1.3	.09	2.3	3/32	.020	.5		1
HSTTV12-Y			6.00	152.4	.06	1.5	.13	3.3	1/8	.020	.5		1
HSTTV19-Y			6.00	152.4	.09	2.3	.19	4.8	3/16	.020	.5		1
HSTTV25-Y			6.00	152.4	.13	3.3	.25	6.4	1/4	.025	.6		1
HSTTV38-Y			6.00	152.4	.19	4.8	.38	9.7	3/8	.025	.6		1
HSTTV50-Y			6.00	152.4	.25	6.4	.50	12.7	1/2	.025	.6		1
HSTTV75-Y			6.00	152.4	.38	9.7	.75	19.1	3/4	.030	.8		1
HSTTV100-Y			6.00	152.4	.50	12.7	1.00	25.4	1	.035	.9		1

Multiple Colors — Single Diameter

HSTT06-YK1	Flame retardant polyolefin cross-linked except clear [‡]	8 pcs. black 3 pcs. of each color*	6.00	152.4	.03	.8	.06	1.5	1/16	.017	.4	-67°F to 275°F (-55°C to 135°C)	1
HSTT09-YK1		6 pcs. black 3 pcs. of each color*	6.00	152.4	.05	1.3	.09	2.3	3/32	.020	.5		1
HSTT12-YK1		2 pcs. black 3 pcs. of each color*	6.00	152.4	.06	1.5	.13	3.3	1/8	.020	.5		1
HSTT25-YK1		2 pcs. black 2 pcs. of each color*	6.00	152.4	.13	3.3	.25	6.4	1/4	.025	.6		1
HSTT38-YK1		6 pcs. black 1 pc. of each color*	6.00	152.4	.19	4.8	.38	9.7	3/8	.025	.6		1
HSTT50-YK1		4 pcs. black 1 pc. of each color*	6.00	152.4	.25	6.4	.50	12.7	1/2	.025	.6		1
HSTT75-YK1		2 pcs. black 1 pc. of each color*	6.00	152.4	.38	9.7	.75	19.1	3/4	.030	.8		1
HSTT100-YK1		1 pc. black 1 pc. of each color*	6.00	152.4	.50	12.7	1.00	25.4	1	.035	.9		1

Black Only — Multiple Diameters

HSTT-YK1	Flame retardant polyolefin cross-linked [^]	Black	6.00	152.4	—	—	—	—	Various - Small Range	—	—	-67°F to 275°F (-55°C to 135°C)	1
HSTT-YK2			6.00	152.4	—	—	—	—	Various - Large Range	—	—		1

Yellow/Green Stripe — Multiple Diameters

HSTT-YK1-45	Flame retardant polyolefin cross-linked [^]	Yellow/Green	6.00	152.4	—	—	—	—	Various - Small Range	—	—	-67°F to 275°F (-55°C to 135°C)	1
HSTT-YK2-45			6.00	152.4	—	—	—	—	Various - Large Range	—	—		1

*Colors include clear^{^^}, red, yellow, green, blue and white.

[^]Meets Mil Spec AMS-DTL-23053/5 Class 1.

^{^^}Meets Mil Spec AMS-DTL-23053/5 Class 3.

[‡]Meets Mil Spec AMS-DTL-23053/5 Class 1 except clear which is manufactured from non-flame retardant polyolefin cross-linked material and meets AMS-DTL-23053/5 Class 2.

Index



Crystal Clear PVC Heat Shrink

- Low shrink temperature (store below 90° F) to speed installation
- Crystal clear material ensures easy to read labels and splice inspections
- Highly flame retardant product manufactured from a material that is rated UL224 VW-1
- Shrink ratio of 2:1 insulates a wide range of diameters and irregular shapes



Part Number	Material	Color	Continuous Use Temperature Range	Max. Recovered I.D.		Min. Expanded I.D.		Nominal I.D.		Nominal Recovered Wall Thickness		Std. Pkg. Qty.
				In.	mm	In.	mm	In.	mm	In.	mm	
HSTTPN50-438-L	Highly flame retardant non cross-linked PVC ^{^^}	Clear	-31°F to 221°F (-35°C to 105°C)	.25	6.4	.50	12.7	.50	12.7	.030	.8	50
HSTTPN50-713-Q				.25	6.4	.50	12.7	.50	12.7	.030	.8	25
HSTTPN62-750-Q				.31	7.9	.63	15.9	.63	15.9	.040	1.0	25
HSTTPN75-775-Q				.38	9.5	.75	19.1	.75	19.1	.040	1.0	25
HSTTPN100-775-Q				.50	12.7	1.00	25.4	1.00	25.4	.040	1.0	25
HSTTPN150-925-X				.75	19.1	1.50	38.1	1.50	38.1	.050	1.3	10
HSTTPN200-950-X				1.00	25.4	2.00	50.8	2.00	50.8	.050	1.3	10
HSTTPN50-CC				.25	6.4	.50	12.7	.50	12.7	.030	.8	1
HSTTPN62-CC				.31	7.9	.63	15.9	.63	15.9	.040	1.0	1
HSTTPN75-CC				.38	9.5	.75	19.1	.75	9.1	.040	1.0	1
HSTTPN100-CC				.50	12.7	1.00	25.4	1.00	25.4	.040	1.0	1
HSTTPN150-CC				.75	19.1	1.50	38.1	1.50	38.1	.050	1.3	1
HSTTPN200-CC				1.00	25.4	2.00	50.8	2.00	50.8	.050	1.3	1

^{^^}Meets Mil Spec AMS-DTL-23053/2 Class 2.

Thick Wall Polyolefin Heat Shrink



- Shrink ratio of 3:1 insulates a wide range of diameters and irregular shapes, which reduces inventory costs
- Cross-linked, UV resistant material improves flame retardancy, chemical and temperature resistance
- Thick wall product seals and insulates in one step to speed installation



Except HST3.0



Black Only



Part Number	Material	Color	Length		Copper Conductor Size Range	Max. Recovered I.D.		Min. Expanded I.D.		Nominal Recovered Wall Thickness		Temperature Range	Std. Pkg. Qty.
			In.	mm		In.	mm	In.	mm	In.	mm		
HST0.4-3-Q*	Flame retardant polyolefin cross-linked with adhesive††	Black	3.00	76.2	#12 – #6 AWG	.15	3.8	.40	10.1	.090	2.3	-85°F to 230°F (-65°C to 110°C)	25
HST0.4-6-3			6.00	152.4		.15	3.8	.40	10.1	.090	2.3		3
HST0.4-6-X*			6.00	152.4		.15	3.8	.40	10.1	.090	2.3		10
HST0.4-48-5*			48.00	1200.0	.15	3.8	.40	10.1	.090	2.3	5		
HST0.8-6-3			6.00	152.4	.20	5.1	.80	20.3	.110	2.8	3		
HST0.8-6-X*			6.00	152.4	.20	5.1	.80	20.3	.110	2.8	10		
HST0.8-9-X*			9.00	228.6	.20	5.1	.80	20.3	.110	2.8	10		
HST0.8-12-5*			12.00	304.8	.20	5.1	.80	20.3	.110	2.8	5		
HST0.8-48-5*			48.00	1200.0	.20	5.1	.80	20.3	.110	2.8	5		
HST1.1-6-3			6.00	152.4	.37	9.4	1.10	27.9	.120	3.0	3		
HST1.1-6-X*			6.00	152.4	.37	9.4	1.10	27.9	.120	3.0	10		
HST1.1-9-2			9.00	228.6	.37	9.4	1.10	27.9	.120	3.0	2		
HST1.1-9-X*			9.00	228.6	.37	9.4	1.10	27.9	.120	3.0	10		
HST1.1-12-5*			12.00	304.8	.37	9.4	1.10	27.9	.120	3.0	5		
HST1.1-48-5*			48.00	1200.0	.37	9.4	1.10	27.9	.120	3.0	5		
HST1.5-9-X			9.00	228.6	.50	12.7	1.50	38.1	.170	4.3	10		
HST1.5-12-1			12.00	304.8	.50	12.7	1.50	38.1	.170	4.3	1		
HST1.5-12-5			12.00	304.8	.50	12.7	1.50	38.1	.170	4.3	5		
HST1.5-48-5			48.00	1200.0	.50	12.7	1.50	38.1	.170	4.3	5		
HST2.0-9-5			9.00	228.6	.65	16.5	2.00	50.8	.170	4.3	5		
HST2.0-12-2			12.00	304.8	.65	16.5	2.00	50.8	.170	4.3	2		
HST2.0-48-2			48.00	1200.0	.65	16.5	2.00	50.8	.170	4.3	2		
HST3.0-12-2			12.00	304.8	1.00	25.4	3.00	76.2	.170	4.3	2		
HST3.0-48-2			48.00	1200.0	1.00	25.4	3.00	76.2	.170	4.3	2		

*For red, add 2 to end of part number package suffix (Example HST0.4-3-Q2).

††Meets Mil Spec AMS-DTL-23053/15 Class 1.

System Overview

Terminals

Disconnects

Splices

Ferrules

Compression Connectors

Crimping Tools

Mechanical Connectors

Grounding Connectors

Support Products

Technical Info

Index

System Overview



Heat Shrink End Caps

Terminals



- Heat indicating line ensures correct temperature is applied
- Cross-linked, UV resistant material improves flame retardancy, chemical and temperature resistance
- Shrink ratio of 3:1 insulates a wide range of diameters and irregular shapes, which reduces inventory costs

Disconnects

Splices

Ferrules

Compression Connectors

Crimping Tools

Mechanical Connectors

Grounding Connectors

Support Products

Technical Info

Index

Part Number	Material	Color	Cap Length		Copper Conductor Size Range	Max. Recovered I.D.		Min. Expanded I.D.		Nominal Recovered Wall Thickness		Temperature Range	Std. Pkg. Qty.
			In.	mm		In.	mm	In.	mm	In.	mm		
HSEC0.5-X	Polyolefin cross-linked with adhesive	Black	1.38	35.1	#8 – #4 AWG	.18	4.6	.47	11.9	.100	2.5	-67°F to 221°F (-55°C to 105°C)	10
HSEC0.8-X			2.13	54.1	#4 – #3/0 AWG	.30	7.6	.79	20.1	.100	2.5		10
HSEC1.0-X			3.23	82.0	#2 – #4/0 AWG	.45	11.4	1.02	25.9	.100	2.5		10
HSEC1.5-5			3.86	98.0	#250 – #500 MCM	.68	17.3	1.58	40.1	.110	2.8		5
HSEC2.0-5			5.52	140.2	#600 – #1000 MCM	.87	22.1	2.25	57.2	.150	3.8		5
HSEC4.0-2			6.90	175.3	#1500 – #2000 MCM	1.78	45.2	4.14	105.2	.150	3.8		2
HSECFR0.5-X*	Flame retardant cross-linked polyolefin with adhesive	Black	3.00	76.2	#8 – #6 AWG	.16	4.1	.51	13.0	.090	2.4	-67°F to 230°F (-55°C to 110°C)	10
HSECFR0.8-X*			3.50	88.9	#6 – #2 AWG	.24	6.1	.75	19.0	.090	2.4		10
HSECFR1.0-X*			4.00	101.6	#1 – #3/0 MCM	.35	8.9	1.10	27.9	.120	3.0		10
HSECFR1.5-5*			4.50	114.3	#2/0 – #350 MCM	.47	11.9	1.50	38.1	.160	4.1		5
HSECFR2.0-5*			4.50	114.3	#250 – #500 MCM	.63	16.0	2.00	50.8	.160	4.1		5

*Flame retardant products are manufactured from a material that is rated UL94V-0.

Labeling & Administration

PANACEA® LS7 Hand-Held Thermal Transfer Printer and Accessories



- Multi-purpose printer features the ability to create cable labels with repeat legends, continuous tapes, component labels, bin markers and safety/facility identification
- High quality thermal transfer print for professional looking labels that will not smear
- Fast loading label cassette includes both label material and ribbon to make changing labels easy
- Advanced functions including repeat legend, serialization, vertical and horizontal lines, symbol library and memory
- Six AA alkaline batteries and hardside case included

Part Number	Part Description	Std. Pkg. Qty.	Std. Ctn. Qty.
LS7	Includes printer, 6 AA alkaline batteries, 3/4" (18mm) non-laminated black/white cassette, hardside carrying case, wrist strap, label separator tool and operator's manual	1	4
LS7-ACS	120 VAC adapter*	1	6
LS7-CLN	Cleaning kit	1	20

*Cannot be used to charge batteries.

For detailed information on the PANACEA® LS7 Hand-held Thermal Transfer Printer, request product bulletin SA-IDCB1000A.

VIPER™ LS6 Portable Thermal Transfer Printer and Accessories



- Create wiremarkers, heat shrink labels, continuous tapes, component labels, bin markers, pipe markers, safety/facility identification and network connectivity labels
- High quality thermal transfer print for professional looking labels that will not smear
- AC adapter included so you can start printing right out of the box
- Serial port / PC interfacing
- Fast loading ribbon cartridge lets you slide, lock and go!
- 128K file memory reduces setup time by recalling frequently used labels
- Nickel metal hydride battery provides longer battery life
- Advanced functions including serialization, bar code printing, vertical and horizontal lines, date and time stamp, variety of font sizes and a symbol library containing over 35 electrical, safety and network symbols

Part Number	Part Description	Std. Pkg. Qty.	Std. Ctn. Qty.
LS6-KIT	Includes printer, AC power adapter/charger, LS6-RWBLK ribbon, hardside carrying case and operator's manual	1	—
LS6-RWBLK	Black, wax ribbon, 2.00" x 100.0'. For use with self-laminating and non-laminated labels	1	6
LS6-RRBLK	Black, resin ribbon, 2.00" x 100.0'. For use with component labels and continuous tape	1	6
LS6-RRWHT	White, resin ribbon, 2.00" x 75.0'. For use with component labels and continuous tape	1	6
LS6-RHBLK	Black, hybrid ribbon, 2.00" x 100.0'. For use with self-laminating, heat shrink, component, non-laminated and vinyl cloth labels	1	6
LS6-BP	Replacement battery pack	1	6
LS6-ACS	North America AC power adapter/charger	1	—
LS6-PCKIT	PC interface kit includes serial cable and VIPERLINK™ software	1	—
LS6-CLN	5 cleaning cards	1	5

For a full product offering on the VIPER™ LS6 Portable Thermal Transfer Printer, request product bulletin SA-ID07BR01B.

System Overview

Terminals

Disconnects

Splices

Ferrules

Compression Connectors

Crimping Tools

Mechanical Connectors

Grounding Connectors

Support Products

Technical Info

Index

System Overview

PAN-QUIK™ LS3E Hand-Held Dot Matrix Printer and Accessories



Terminals

- Lightweight, versatile printer for high quality labels that you can print anytime, anywhere
- Flexibility to print self-laminating cable labels, heat shrink labels and network system component labels faster than other hand-held dot-matrix printers
- Features the *QUIK-KEY™* Fast Label Formatting System for reduced set-up time
- 20Kb file storage memory saves time when producing frequently used labels
- Automatic serialization and legend repeat functions
- Automatic recall of last legend entered so there is no need to re-enter information after shut-off or recharging battery pack
- Rotated legends allow printing of continuous strips for marking terminal blocks, patch panels and more!

Disconnects

Part Number	Part Description	Std. Pkg. Qty.	Std. Ctn. Qty.
LS3E-KIT	Includes printer, battery pack, battery charger, printer ribbon, wrist strap and operator's manual, plus LS3EAK-S AC adapter and carrying case	1	—
LS3-RIB	Replacement ribbon	1	6

For detailed information on the *PAN-QUIK™* LS3E Hand-held Dot Matrix Printer, request product bulletin SA-101N398A-ID.

Splices

Splices

TDP43M Thermal Transfer Desktop Printer and Accessories



Ferrules

- *It's Quick!* – Custom capability allows high quality labels to be produced in-house for medium volume applications
- Choose from an assortment of self-laminating wire markers, heat shrink markers, vinyl cloth wire/cable markers, continuous vinyl tape and component labels
- Produces high quality, 300 dpi thermal transfer print for labels that are both professional and robust
- Works with most standard PC's and labeling printing software including *PANDUIT® EASY-MARK™* or *PAN-MARK®* for *WINDOWS®* Labeling Software
- Flexibility and speed make the TDP43M a useful tool for your on-demand labeling needs!

Compression Connectors

Part Number	Part Description	Std. Pkg. Qty.
TDP43M	300 dpi printer; includes printer, <i>PANDUIT® EASY-MARK™</i> labeling software, RMH4BL hybrid black ribbon, AC power adapter with US and Europlug power cords, manual and quick start card	1
TDP43M-RS	External label roll stand - used to rear feed labels that are supplied on 3.00" cores	1

^WINDOWS is a registered trademark of Microsoft Corp. in the United States and/or other countries.
For detailed information on the TDP43M Thermal Transfer Desktop Printer, request product bulletin SA-IDCB17.

Crimping Tools

Thermal Transfer Ribbons for use with the TDP43M Thermal Transfer Desktop Printer



Mechanical Connectors

- Available in three types:
- **Resin** for harsh environments
 - **Hybrid** for printing on a wide range of materials
 - **Wax** for general purpose labeling

Grounding Connectors

Part Number	Part Description	Height		Length		Std. Pkg. Qty.	Std. Ctn. Qty.
		In.	mm	ft.	M		
RMH2BL	Black, hybrid thermal transfer ribbon. For use with heat shrink and vinyl cloth labels	2.52	63.50	240.0	73.0	1	12
RMH4BL	Black, hybrid thermal transfer ribbon. For use with heat shrink and vinyl cloth labels	4.33	110.00	240.0	73.0	1	12
RMW2BL	Black, wax thermal transfer ribbon. For use with self-laminating vinyl, self-laminating polyester and self-laminating TEDLAR‡ labels	2.52	63.50	240.0	73.0	1	12
RMW4BL	Black, wax thermal transfer ribbon. For use with self-laminating and non-laminated labels	4.33	110.00	240.0	73.0	1	12
RMR2BL	Black, resin thermal transfer ribbon. For use with component labels and continuous tape	2.52	63.50	240.0	73.0	1	12
RMR2WH	White, resin thermal transfer ribbon. For use with component labels and continuous tape	2.52	63.50	240.0	73.0	1	12
RMR4BL	Black, resin thermal transfer ribbon. For use with component labels and continuous tape	4.33	110.00	240.0	73.0	1	12
RMR4BU	Blue, resin thermal transfer ribbon. For use with component labels and continuous tape	4.33	110.00	240.0	73.0	1	12
RMR4GR	Green, resin thermal transfer ribbon. For use with component labels and continuous tape	4.33	110.00	240.0	73.0	1	12
RMR4RD	Red, resin thermal transfer ribbon. For use with component labels and continuous tape	4.33	110.00	240.0	73.0	1	12
RMR4WH	White, resin thermal transfer ribbon. For use with component labels and continuous tape	4.33	110.00	240.0	73.0	1	12

Order number of ribbons required.

Support Products

Technical Info

Index

PAN-MARK® for WINDOWS[^] Labeling Software

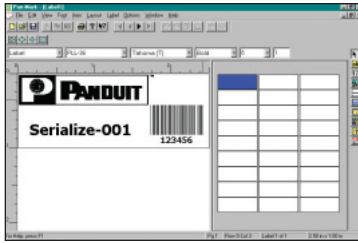

- PAN-MARK® for WINDOWS[^] Labeling Software has preloaded and ready to use, thermal transfer, dot-matrix, laser and ink jet label formats.
- ODBC (Open Data-Base Connectivity) allows importing of information from electronic databases such as EXCEL[^] and ACCESS[^] directly onto the label formats
- On-line help function files, including the TIA/EIA-606-A Labeling Compliance Brochure that assists in understanding the TIA/EIA-606-A standard and insure network labeling compliance
- Easy to install and supplied on CD-ROM
- Uses full range of WINDOWS[^] fonts including True Type* fonts
- Use image library to add commonly used symbols to your labels (fax, data, voice, etc.)
- Import bitmap (.bmp) graphic images into a label
- Create alpha and numeric serializations

System Requirements:

- WINDOWS[^] 95, 98, Me, 2000, NT 4.x, and XP; minimum 486 processor; minimum 8MB of RAM; 30 MB hard drive space

Part Number	Part Description	Std. Pkg. Qty.	Std. Ctn. Qty.
PROG-WIN2CD	PAN-MARK® 2.5 for WINDOWS [^] labeling software supplied on CD-ROM	1	10

For detailed information on PAN-MARK® for WINDOWS[^] Labeling Software, request product bulletin SA-IDCB1043A.

[^]WINDOWS, EXCEL and ACCESS are registered trademarks of Microsoft Corp. in the United States and other countries.

*True Type is a registered trademark of Apple Computing.

EASY-MARK™ Labeling Software

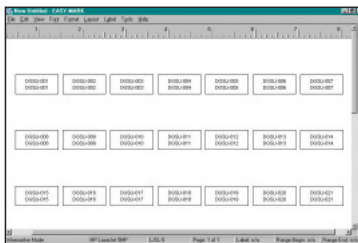

- WYSIWYG — What You See Is What You Get — program allows you to see labels on-screen as they will appear when printed
- Quick text entry — feature allows you to enter text on individual labels or over an entire range
- Advanced alpha and numeric serialization speeds label creation
- All PANDUIT® thermal transfer, dot-matrix, laser and inkjet label formats
- On-line help function files, including the TIA/EIA-606-A Labeling Compliance Brochure that assists in understanding the TIA/EIA-606-A standard and insure network labeling compliance
- Easy to install and supplied on CD-ROM
- Uses full range of WINDOWS[^] fonts including True Type* fonts

System Requirements:

- WINDOWS[^] 95, 98, Me, 2000, NT4.x, and XP; minimum 486 processor; minimum 32 MB RAM; 64 MB hard drive space

Part Number	Part Description	Std. Pkg. Qty.	Std. Ctn. Qty.
PROG-EMCD	EASY-MARK™ labeling software supplied on CD-ROM	1	10

For detailed information on EASY-MARK™ Labeling Software, request product bulletin SA-IDCB02.

[^]WINDOWS is a registered trademark of Microsoft Corp. in the United States and other countries.

*True Type is a registered trademark of Apple Computing.

System Overview

Terminals

Disconnects

Splices

Ferrules

Compression Connectors

Crimping Tools

Mechanical Connectors

Grounding Connectors

Support Products

Technical Info

Index

System Overview

Self-Laminating Labels for Wire and Cables



Terminals

- Labels for wire/cable applications are specifically sized and consistent across print technologies: laser/ink jet, thermal transfer, dot matrix and portable printers
- **PANDUIT®** labeling software packages include all label formats to quickly and economically identify wires and cables
- White print-on area with clear overlamine protects legend for clear and durable identification

Disconnects

Self-Laminating Labels for Laser/Ink Jet Desktop Printers Supplied on 8.5" x 11" Sheets

Splices	Part Number	Part Description	Width		Length		Print-On Height		Min. Cable O.D.		Max. Cable O.D.		Std. Pkg. Qty.*	Std. Ctn. Qty.
			In.	mm	In.	mm	In.	mm	In.	mm	In.	mm		
	S050X075YAJ	White print-on, self-laminating polyester label	.50	12.70	.75	19.05	.25	6.35	.08	2.02	.16	4.04	5000	25000
	S050X125YAJ	White print-on, self-laminating polyester label	.50	12.70	1.25	31.75	.38	9.65	.12	3.03	.28	7.03	5000	25000
	S050X150YAJ	White print-on, self-laminating polyester label	.50	12.70	1.50	38.10	.50	12.70	.16	4.07	.32	8.09	5000	25000
Ferrules	S100X075YAJ	White print-on, self-laminating polyester label	1.00	25.40	.75	19.05	.25	6.35	.08	2.02	.16	4.07	2500	10000
	S100X125YAJ	White print-on, self-laminating polyester label	1.00	25.40	1.25	31.75	.38	9.65	.12	3.07	.28	7.03	2500	10000
	S100X150YAJ	White print-on, self-laminating polyester label	1.00	25.40	1.50	38.10	.50	12.70	.16	4.04	.32	8.09	2500	10000
	S100X225YAJ	White print-on, self-laminating polyester label	1.00	25.40	2.25	57.15	.75	19.05	.24	6.06	.48	12.13	1000	5000
Compression Connectors	S100X400YAJ	White print-on, self-laminating polyester label	1.00	25.40	4.00	101.60	1.00	25.40	.32	8.09	.95	24.26	1000	5000
	S100X650YAJ	White print-on, self-laminating polyester label	1.00	25.40	6.50	165.10	1.50	38.10	.48	12.13	1.59	40.43	1000	5000
	S200X225YAJ	White print-on, self-laminating polyester label	2.00	50.80	2.25	57.15	.75	19.05	.24	6.06	.48	12.13	1000	5000
	S200X400YAJ	White print-on, self-laminating polyester label	2.00	50.80	4.00	101.60	1.00	25.40	.32	8.09	.95	24.26	1000	5000
	S200X650YAJ	White print-on, self-laminating polyester label	2.00	50.80	6.50	165.10	1.50	38.10	.48	12.13	1.59	40.43	500	2500

*Order number of labels required in multiples of Std. Pkg. Qty.

Crimping Tools

Self-Laminating Labels for TDP43M Thermal Transfer Desktop Printer Supplied on Rolls

Mechanical Connectors	Part Number	Part Description	Width		Length		Print-On Height		Min. Cable O.D.		Max. Cable O.D.		Std. Pkg. Qty.*	Std. Ctn. Qty.
			In.	mm	In.	mm	In.	mm	In.	mm	In.	mm		
	S050X075VA1	White print-on, self-laminating vinyl label	.50	12.70	.75	19.05	.25	6.35	.08	2.02	.16	4.04	5000	20000
	S050X125VA1	White print-on, self-laminating vinyl label	.50	12.70	1.25	31.75	.38	9.65	.12	3.07	.28	7.03	5000	20000
	S050X150VA1	White print-on, self-laminating vinyl label	.50	12.70	1.50	38.10	.50	12.70	.16	4.04	.32	8.09	5000	60000
Grounding Connectors	S100X075VA1	White print-on, self-laminating vinyl label	1.00	25.40	.75	19.05	.25	6.35	.08	2.02	.16	4.04	2500	10000
	S100X125VA1	White print-on, self-laminating vinyl label	1.00	25.40	1.25	31.75	.38	9.65	.12	3.07	.28	7.03	2500	10000
	S100X150VA1	White print-on, self-laminating vinyl label	1.00	25.40	1.50	38.10	.50	12.70	.16	4.04	.32	8.09	2500	30000
	S100X225VA1	White print-on, self-laminating vinyl label	1.00	25.40	2.25	57.15	.75	19.05	.24	6.06	.48	12.13	1500	18000
	S100X400VA1	White print-on, self-laminating vinyl label	1.00	25.40	4.00	101.60	1.00	25.40	.32	8.09	.95	24.26	1000	4000
	S100X650VA1	White print-on, self-laminating vinyl label	1.00	25.40	6.50	165.10	1.50	38.10	.48	12.13	1.59	40.43	250	1000
	S200X225VA1	White print-on, self-laminating vinyl label	2.00	50.80	2.25	57.15	.75	19.05	.24	6.06	.48	12.13	500	2000
	S200X400VA1	White print-on, self-laminating vinyl label	2.00	50.80	4.00	101.60	1.00	25.40	.32	8.09	.95	24.26	500	2000
Support Products	S200X650VA1	White print-on, self-laminating vinyl label	2.00	50.80	6.50	165.10	1.50	38.10	.48	12.13	1.59	40.43	250	1000

*Order number of rolls required.

Also available on 3" core size, replace S100X075VA* with T.

Technical Info

Index

Cable Marking Cassette for *PANACEA*[®] LS7 Hand-Held Thermal Transfer Printer

Part Number	Part Description	Height		Length		Std. Pkg. Qty.	Std. Ctn. Qty.
		In.	mm	Ft.	M		
LS7-75NL-1	Black/white, non-laminated polyester label cassette.	.708	17.98	26.20	8.00	1	20
LS7-75NL-2	Black/clear, non-laminated polyester label cassette.	.708	18.00	26.2	8.00	1	20

Self-Laminating Labels for *VIPER*[™] LS6 Portable Thermal Transfer Printer Supplied on Rolls

Part Number	Part Description	Width		Length		Print-On Height		Min. Cable O.D.		Max. Cable O.D.		Std. Pkg. Qty.*	Std. Ctn. Qty.
		In.	mm	In.	mm	In.	mm	In.	mm	In.	mm		
S050X075VA6	White print-on, self-laminating vinyl label, 500/roll	.50	12.70	.75	19.05	.25	6.35	.08	2.02	.16	4.04	1	10
S050X125VA6	White print-on, self-laminating vinyl label, 350/roll	.50	12.70	1.25	31.75	.38	9.65	.12	3.07	.28	7.03	1	10
S050X150VA6	White print-on, self-laminating vinyl label, 250/roll	.50	12.70	1.50	38.10	.50	12.70	.16	4.04	.32	8.09	1	10
S100X075VA6	White print-on, self-laminating vinyl label, 250/roll	1.00	25.40	.75	19.05	.25	6.35	.08	2.02	.16	4.04	1	10
S100X125VA6	White print-on, self-laminating vinyl label, 250/roll	1.00	25.40	1.25	31.75	.38	9.65	.12	3.07	.28	7.03	1	10
S100X150VA6	White print-on, self-laminating vinyl label, 250/roll	1.00	25.40	1.50	38.10	.50	12.70	.16	4.04	.32	8.09	1	10
S100X225VA6	White print-on, self-laminating vinyl label, 150/roll	1.00	25.40	2.25	57.15	.75	19.05	.24	6.06	.48	12.13	1	10
S100X400VA6	White print-on, self-laminating vinyl label, 100/roll	1.00	25.40	4.00	101.60	1.00	25.40	.32	8.09	.95	24.26	1	10
S100X650VA6	White print-on self-laminating vinyl label, 50/roll	1.00	25.40	6.50	165.10	1.50	38.10	.48	12.13	1.59	40.43	1	10
S200X225VA6	White print-on, self-laminating vinyl label, 150/roll	2.00	50.80	2.25	57.15	.75	19.05	.24	6.06	.48	12.13	1	10
S200X400VA6	White print-on, self-laminating vinyl label, 100/roll	2.00	50.80	4.00	101.60	1.00	25.40	.32	8.09	.95	24.26	1	10
S200X650VA6	White print-on, self-laminating vinyl label, 50/roll	2.00	50.80	6.50	165.10	1.50	38.10	.48	12.13	1.59	40.43	1	10

Self-Laminating Labels for *PAN-QUIK*[™] LS3E Hand-Held Dot Matrix Printer Supplied on Rolls

Part Number	Part Description	Width		Length		Print-On Height		Min. Cable O.D.		Max. Cable O.D.		Std. Pkg. Qty.*	Std. Ctn. Qty.
		In.	mm	In.	mm	In.	mm	In.	mm	In.	mm		
S050X075VA3	White print-on, self-laminating vinyl label, 250/roll	.50	12.70	.75	19.05	.25	6.35	.08	2.02	.16	4.04	1	10
S050X125VA3	White print-on, self-laminating vinyl label, 250/roll	.50	12.70	1.25	31.75	.38	9.65	.12	3.07	.28	7.03	1	10
S050X150VA3	White print-on, self-laminating vinyl label, 250/roll	.50	12.70	1.50	38.10	.50	12.70	.16	4.04	.32	8.09	1	10
S100X075VA3	White print-on self-laminating vinyl label, 250/roll	1.00	25.40	.75	19.05	.25	6.35	.08	2.02	.16	4.04	1	10
S100X125VA3	White print-on, self-laminating vinyl label, 250/roll	1.00	25.40	1.25	31.75	.38	9.65	.12	3.07	.28	7.03	1	10
S100X150VA3	White print-on, self-laminating vinyl label, 250/roll	1.00	25.40	1.50	38.10	.50	12.70	.16	4.04	.32	8.09	1	10
S100X225VA3	White print-on, self-laminating vinyl label, 150/roll	1.00	25.40	2.25	57.15	.75	19.05	.24	6.06	.48	12.13	1	10

System Overview

Terminals

Disconnects

Splices

Ferrules

Compression Connectors

Crimping Tools

Mechanical Connectors

Grounding Connectors

Support Products

Technical Info

Index

System Overview

Heat Shrink Labels for Wire and Cables

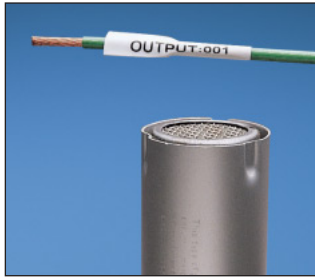

- Produce durable, high quality chemical/abrasion resistant heat shrink markers
- Pre-cut tubing mounted on plastic carrier
- Flattened polyolefin material
- Service temperature range: -22° to 220° (-30°C to 105°C)
- Shrink ratio 3:1 at 212°F (100°C)

- Meets UL Standard 224 for flammability
- For best results when using desktop thermal transfer printers use *PANDUIT®* hybrid thermal transfer ribbon, TTRH-BL found on [page K30](#). When using the *VIPER™* LS6 Portable Thermal Transfer Printer, use with LS6-RHBLK found on [page K29](#).

Terminals

Disconnects

Heat Shrink Labels for Thermal Transfer Desktop Printers Supplied on Rolls

Splices	Part Number	Part Description	Width		Length		Min. Cable O.D.		Max. Cable O.D.		Std. Pkg. Qty.	Std. Ctn. Qty.	
			In.	mm	In.	mm	In.	mm	In.	mm			
	H050X025F1T	White, 1/8" diameter heat shrinkable polyolefin, 2000/roll.	.50	12.70	.25	6.35	.13	3.30	.04	1.02	1	—	
‡	H050X034F1T	White, 3/16" diameter heat shrinkable polyolefin, 2000/roll.	.50	12.70	.34	8.64	.19	4.83	.068	1.5257	1	—	
‡	H050X044F1T	White, 1/4" diameter heat shrinkable polyolefin, 2000/roll.	.50	12.70	.44	11.18	.25	6.35	.08	2.03	1	—	
Ferrules	H075X025F1T	White, 1/8" diameter heat shrinkable polyolefin, 2000/roll.	.75	19.05	.25	6.35	.13	3.30	.04	1.02	1	—	
	H075X034F1T	White, 3/16" diameter heat shrinkable polyolefin, 1000/roll.	.75	19.05	.34	8.64	.19	4.57	.06	1.52	1	—	
	H075X044F1T	White, 1/4" diameter heat shrinkable polyolefin, 1000/roll.	.75	19.05	.44	11.18	.25	6.35	.08	2.03	1	—	
‡	H100X025F1T	White, 1/8" diameter heat shrinkable polyolefin, 1000/roll.	1.00	25.40	.25	6.35	.13	3.30	.04	1.02	1	—	
‡	H100X034F1T	White, 3/16" diameter heat shrinkable polyolefin, 1000/roll.	1.00	25.40	.34	8.64	.19	4.83	.06	1.52	1	—	
‡	H100X044F1T	White, 1/4" diameter heat shrinkable polyolefin, 1000/roll.	1.00	25.40	.44	11.18	.25	6.35	.08	2.03	1	—	
Compression Connectors	‡	H100X064F1T	White, 3/8" diameter heat shrinkable polyolefin, 1000/roll.	1.00	25.40	.64	16.26	.38	9.65	.13	3.30	1	—
		H100X084F1T	White, 1/2" diameter heat shrinkable polyolefin, 1000/roll.	1.00	25.40	.84	21.34	.50	12.70	.17	4.32	1	—
		H100X165F1T	White, 1" diameter heat shrinkable polyolefin, 500/roll.	1.00	25.40	1.65	41.91	1.00	25.40	.33	8.38	1	—
		H150X025F1T	White, 1/8" diameter heat shrinkable polyolefin, 500/roll.	1.50	38.10	.25	6.35	.13	3.30	.04	1.02	1	—
Crimping Tools		H150X034F1T	White, 3/16" diameter heat shrinkable polyolefin, 500/roll.	1.50	38.10	.34	8.64	.19	4.83	.06	1.52	1	—
		H150X044F1T	White, 1/4" diameter heat shrinkable polyolefin, 500/roll.	1.50	38.10	.44	11.18	.25	6.35	.08	2.03	1	—
	‡	H200X025F1T	White, 1/8" diameter heat shrinkable polyolefin, 500/roll.	2.00	50.80	.25	6.35	.13	3.30	.04	1.02	1	—
‡	H200X034F1T	White, 3/16" diameter heat shrinkable polyolefin, 500/roll.	2.00	50.80	.34	8.64	.19	4.83	.06	1.52	1	—	
‡	H200X044F1T	White, 1/4" diameter heat shrinkable polyolefin, 500/roll.	2.00	50.80	.44	11.18	.25	6.35	.08	2.03	1	—	
Mechanical Connectors	‡	H200X064F1T	White, 3/8" diameter heat shrinkable polyolefin, 500/roll.	2.00	50.80	.64	16.26	.38	9.65	.13	3.30	1	—
		H200X084F1T	White, 1/2" diameter heat shrinkable polyolefin, 500/roll.	2.00	50.80	.84	21.34	.50	12.70	.17	4.32	1	—
		H200X165F1T	White, 1" diameter heat shrinkable polyolefin, 250/roll.	2.00	50.80	1.65	41.91	1.00	25.40	.33	8.38	1	—

‡Bulk packaging available, add *-B to end of part number. Bulk packaging quantity is 5 times the standard roll quantity.
 Also printable with pin feed for dot matrix printers.
 Other colors available, contact *PANDUIT®* Customer Service, 800-777-3300.

Grounding Connectors

Heat Shrink Labels for *VIPER™* LS6 Portable Thermal Transfer Printer Supplied on Rolls

Part Number	Part Description	Width		Length		Min. Cable O.D.		Max. Cable O.D.		Std. Pkg. Qty.*	Std. Ctn. Qty.
		In.	mm	In.	mm	In.	mm	In.	mm		
H050X025F16	White, 1/8" heat shrinkable polyolefin, 200/roll.	.50	12.70	.25	6.35	.04	1.02	.13	3.30	1	10
H050X034F16	White, 3/16" heat shrinkable polyolefin, 200/roll.	.50	12.70	.34	8.64	.06	1.52	.19	4.83	1	10
H050X044F16	White, 1/4" heat shrinkable polyolefin, 200/roll.	.50	12.70	.44	11.18	.08	2.03	.25	6.35	1	10
H100X025F16	White, 1/8" heat shrinkable polyolefin, 100/roll.	1.00	25.40	.25	6.35	.04	1.02	.13	3.30	1	10
H100X034F16	White, 3/16" heat shrinkable polyolefin, 100/roll.	1.00	25.40	.34	8.64	.06	1.52	.19	4.83	1	10
H100X044F16	White, 1/4" heat shrinkable polyolefin, 100/roll.	1.00	25.40	.44	11.18	.08	2.03	.25	6.35	1	10
H100X084F16	White, 1/2" heat shrinkable polyolefin, 100/roll.	1.00	25.40	.84	21.34	.17	4.32	.50	12.70	1	10
H175X025F16	White, 1/8" heat shrinkable polyolefin, 100/roll.	1.75	44.45	.25	6.35	.04	1.02	.13	3.30	1	10
H175X034F16	White, 3/16" heat shrinkable polyolefin, 100/roll.	1.75	44.45	.34	8.64	.06	1.52	.19	4.83	1	10
H175X044F16	White, 1/4" heat shrinkable polyolefin, 100/roll.	1.75	44.45	.44	11.18	.08	2.03	.25	6.35	1	10
H175X084F16	White, 1/2" heat shrinkable polyolefin, 100/roll.	1.75	44.45	.84	21.34	.17	4.32	.50	12.70	1	10

Support Products

Technical Info

Index

Heat Shrink Labels for *PAN-QUIK*™ LS3E Hand-Held Dot Matrix Printer Supplied on Rolls

Part Number	Part Description	Width		Length		Min. Cable O.D.		Max. Cable O.D.		Std. Pkg. Qty.	Std. Ctn. Qty.
		In.	mm	In.	mm	In.	mm	In.	mm		
H050X025F13	White, 1/8" diameter heat shrinkable polyolefin, 200/roll	.50	12.70	.25	6.35	.04	1.02	.13	3.30	1	10
H100X025F13	White, 1/8" diameter heat shrinkable polyolefin, 100/roll	1.00	25.40	.25	6.35	.04	1.02	.13	3.30	1	10
H100X034F13	White, 3/16" diameter heat shrinkable polyolefin, 100/roll	1.00	25.40	.34	8.64	.06	1.52	.18	4.57	1	10
H100X044F13	White, 1/4" diameter heat shrinkable polyolefin, 100/roll	1.00	25.40	.44	11.18	.08	2.03	.25	6.35	1	10
H100X084F13	White, 1/2" diameter heat shrinkable polyolefin, 100/roll	1.00	25.40	.84	21.34	.17	4.32	.50	12.70	1	10

Wire Size Selection Guide

Size AWG	Type THW Wire O.D.		Type THHN Wire O.D.		Type Teflon* Wire O.D.		Type PVC Wire O.D.	
	In.	mm	In.	mm	In.	mm	In.	mm
22	—	—	—	—	.06	1.52	.06	1.57
20	—	—	—	—	.07	1.73	.07	1.75
18	.11	2.74	.09	2.26	.08	2.01	.08	2.01
16	.12	3.00	.10	2.54	.09	2.26	.09	2.34
14	.16	4.11	.11	2.67	—	—	.14	3.51
12	.18	4.55	.12	3.10	—	—	.16	4.01
10	.20	5.05	.15	3.89	—	—	.18	4.65
8	.28	7.01	.22	5.54	—	—	.25	6.35
6	.32	8.20	.26	6.53	—	—	—	—
4	.37	9.45	.33	8.33	—	—	—	—
3	.40	10.19	.36	9.04	—	—	—	—
2	.43	11.00	.39	9.86	—	—	—	—
1	.51	12.90	.45	11.43	—	—	—	—
1/0	.55	13.94	.49	12.47	—	—	—	—
2/0	.60	15.11	.54	13.64	—	—	—	—
3/0	.65	16.43	.59	14.94	—	—	—	—
4/0	.71	17.91	.65	16.41	—	—	—	—

*Approximate dimensions of wire and cable sizes.
Outside diameter measurements are rounded to the nearest hundredth of an inch.

System Overview

Terminals

Disconnects

Splices

Ferrules

Compression Connectors

Crimping Tools

Mechanical Connectors

Grounding Connectors

Support Products

Technical Info

Index

System Overview

Cable Ties PAN-TY® Cable Ties

Terminals



Disconnects

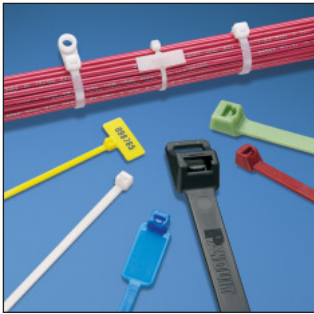

Splices

Ferrules

Compression Connectors



Except
PLT5H/6H/8H/13H
& all EH Ties

Crimping Tools

Mechanical Connectors

Grounding Connectors

Support Products

Technical Info

Index

- One piece construction for consistent performance and reliability
- Lowest threading force of any one piece cable tie in the industry
- Versatile cable ties that can be used in countless applications
- Material: Nylon 6.6

Part Number	Length		Width		Max. Bundle Dia.		Min. Loop Tensile Str.		Recommended Tooling	Std. Pkg. Qty.	Std. Ctn. Qty.
	In.	mm	In.	mm	In.	mm	Lbs.	N			

Miniature Cross Section

PLT1M-C	3.9	99	.098	2.5	.87	22	18	80	GTS, GS2B, PTS, PPTS, STS2	100	1000
PLT1.5M-C	5.6	142	.098	2.5	1.25	32	18	80		100	1000
PLT2M-C	8.0	203	.098	2.5	2.00	51	18	80		100	1000

Intermediate Cross Section

PLT1.5I-C	5.6	142	.142	3.6	1.38	35	40	178	GTS, GS2B, PTS, PPTS, STS2	100	1000
PLT2I-C	8.0	203	.142	3.6	2.00	51	40	178		100	1000
PLT2.5I-C	9.7	246	.145	3.7	2.50	64	40	178		100	1000
PLT3I-C	11.4	290	.145	3.7	3.00	76	40	178		100	1000
PLT4I-C	14.5	368	.145	3.7	4.00	102	40	178		100	1000

Standard Cross Section

PLT1S-C	4.8	122	.190	4.8	1.00	25	50	222	GTS, GS2B, GTH, GS4H, PTS, PPTS, STS2, STH2	100	1000
PLT1.5S-C	6.2	157	.190	4.8	1.50	38	50	222		100	1000
PLT2S-C	7.4	188	.190	4.8	1.88	48	50	222		100	1000
PLT2.5S-C	9.8	249	.190	4.8	2.50	64	50	222		100	1000
PLT3S-C	11.5	292	.190	4.8	3.00	76	50	222		100	1000
PLT4S-C	14.5	368	.190	4.8	4.00	102	50	222		100	1000
PLT4.5S-C	15.5	394	.190	4.8	4.50	114	50	222		100	1000
PLT5S-C	17.5	445	.190	4.8	5.00	127	50	222		100	500

Light-Heavy Cross Section

PLT6LH-L	21.9	556	.300	7.6	6.00	152	120	534	GTH, GS4H, GS4EH, PPTEH, STH2, ST2EH	50	500
PLT7LH-L	24.7	627	.300	7.6	7.00	178	120	534		50	500
PLT8LH-L	27.6	701	.300	7.6	8.00	203	120	534		50	500
PLT9LH-L	30.5	775	.300	7.6	9.00	229	120	534		50	500
PLT10LH-L	34.3	871	.300	7.6	10.31	262	120	534		50	1000

Heavy Cross Section

PLT2H-L	8.1	206	.300	7.6	2.00	51	120	534	GTH, GS4H, GS4EH, PPTEH, STH2, ST2EH	50	500
PLT2.5H-L	9.8	251	.300	7.6	2.50	64	120	534		50	500
PLT3H-L	11.4	290	.300	7.6	3.00	76	120	534		50	500
PLT4H-L	14.5	368	.300	7.6	4.00	102	120	534		50	500
PLT5H-L	17.7	450	.350	8.9	5.00	127	175	778		50	500
PLT6H-L	20.9	530	.350	8.9	6.00	152	175	778		50	500
PLT8H-L	30.6	779	.350	8.9	9.00	229	175	778		50	500
PLT13H-Q	43.3	1100	.350	8.9	13.00	330	175	778		25	500

Extra-Heavy Cross Section

PLT5EH-Q	20.1	511	.500	12.7	5.00	127	250	1112	GS4EH, PPTEH, ST2EH	25	250
PLT6EH-Q	22.2	564	.500	12.7	6.00	152	250	1112		25	250
PLT10EH-C	34.2	869	.500	12.7	10.00	254	250	1112		100	500

For cable tie installation tooling, see [page K41](#).

HOT STAMPING — Custom Printed Cable Ties

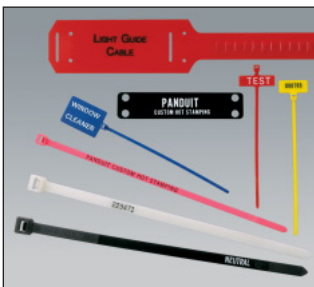

A wide variety of information can be imprinted on **PANDUIT®** cable ties, marker ties and marker plates. Printing utilizes a durable "Hot Stamping" process that is an economical and convenient way to permanently mark cable ties. Customize with a wide variety of choices:

- Seven basic text colors
- Special logos and diagrams (with customer supplied camera-ready artwork)
- Alphanumeric and sequential numbering for serialization
- Fast delivery with approved artwork
- 5,000 piece minimum per part number

DOME-TOP® Barb Ty Cable Ties



- Unique patented design with round, smooth edges
- Stainless steel locking barb provides consistent performance, reliability and infinite adjustability through its entire bundle range
- High strength and low thread force
- Miniature to standard cross sections feature a curved tip for easy threading and handling
- A variety of materials and colors are available for specific applications
- Material: Nylon 6.6

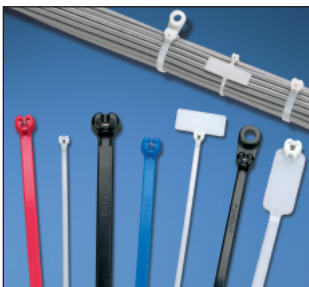

Part Number	Length		Width		Max. Bundle Dia.		Min. Loop Tensile Str.		Recommended Tooling	Std. Pkg. Qty.	Std. Ctn. Qty.
	In.	mm	In.	mm	In.	mm	Lbs.	N			

Miniature Cross Section

BT1M-C	4.0	102	.095	2.4	.90	23	18	80	GTS, GS2B, PTS, PPTS, STS2	100	1000
BT1.5M-C	6.3	160	.095	2.4	1.50	38	18	80		100	1000
BT2M-C	7.9	201	.095	2.4	2.00	51	18	80		100	1000
BT4M-C	14.2	361	.095	2.4	4.00	102	18	80		100	1000

Intermediate Cross Section

BT1.5I-C	6.1	155	.141	3.6	1.50	38	40	178	GTS, GS2B, PTS, PPTS, STS2	100	1000
BT2I-C	8.0	203	.141	3.6	2.00	51	40	178		100	1000
BT3I-C	11.3	288	.141	3.6	3.00	76	40	178		100	1000
BT4I-C	14.3	363	.141	3.6	4.00	102	40	178		100	1000

Standard Cross Section

BT2S-C	8.0	203	.185	4.7	2.00	51	50	222	GTS, GS2B, GTH, GS4H, PTS, PPTS, STS2, STH2	100	1000
BT3S-C	12.0	305	.185	4.7	3.00	76	50	222		100	1000
BT4S-C	15.1	384	.185	4.7	4.00	102	50	222		100	1000

Light-Heavy Cross Section

BT2LH-L	8.7	221	.275	7.0	2.00	51	120	534	GTH, GS4H, GS4EH, PPTEH, STH2, ST2EH	50	500
BT3LH-L	11.8	300	.275	7.0	3.00	76	120	534		50	500
BT4LH-L	14.9	378	.275	7.0	4.00	102	120	534		50	500
BT6LH-L	21.2	538	.275	7.0	6.00	152	120	534		50	500
BT7LH-L	24.4	620	.275	7.0	7.00	178	120	534		50	500
BT8LH-L	27.5	699	.275	7.0	8.00	203	120	534		50	500
BT9LH-L	30.7	780	.275	7.0	9.00	229	120	534		50	500

DOME-TOP® Barb Ty Marker & Flag Ties

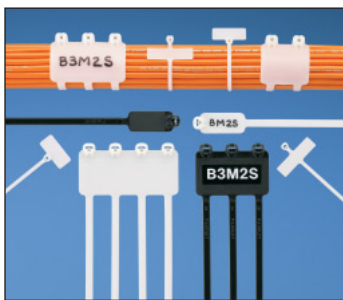

- Used to fasten and identify bundles at the same time
- Stainless steel locking barb
- May be marked with PANDUIT® marker pens, computer printable labels or use PANDUIT® custom hot stamping service (see [page K36](#))
- Miniature to standard cross sections feature a curved tip for easy threading and handling
- A variety of materials and colors are available for specific applications
- Material: Nylon 6.6

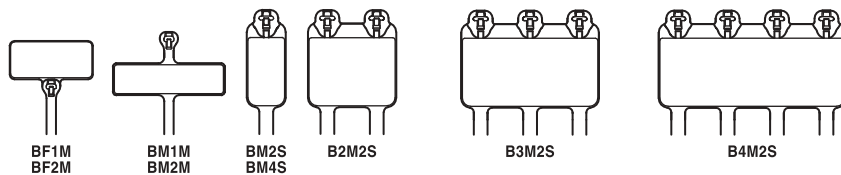

Part Number	Length		Width		Max. Bundle Dia.		Min. Loop Tensile Str.		Write-On Area		Recommended Tooling	Std. Pkg. Qty.	Std. Ctn. Qty.
	In.	mm	In.	mm	In.	mm	Lbs.	N	In.	mm			

Miniature Cross Section

BF1M-C	4.6	117	.095	2.4	.90	23	18	80	.36 x .81	9.1 x 20.6	GTS, GS2B, PTS, PPTS, STS2	100	1000
BF2M-C	8.3	211	.095	2.4	2.00	51	18	80	.36 x .81	9.1 x 20.6		100	1000
BM1M-C	4.2	107	.095	2.4	.90	23	18	80	.29 x 1.09	7.4 x 27.7		100	1000
BM2M-C	7.9	201	.095	2.4	2.00	51	18	80	.29 x 1.09	7.4 x 27.7		100	1000

Standard Cross Section

BM2S-C	8.0	203	.185	4.7	2.00	51	50	222	.49 x .91	12.4 x 23.1	GTS, GS2B, GTH, GS4H, PTS, PPTS, STS2, STH2	100	1000
BM4S-C	15.1	384	.185	4.7	4.00	102	50	222	.50 x 2.13	12.7 x 54.1		100	1000
B2M2S-D	8.0	203	.185	4.7	2.00	51	50	222	1.15 x .91	29.2 x 23.1		500	2500
B3M2S-TL	8.0	203	.185	4.7	2.00	51	50	222	1.81 x .91	46.0 x 23.1		250	2500
B4M2S-TL	8.0	203	.185	4.7	2.00	51	50	222	2.47 x .91	62.7 x 23.1		250	2500

For cable tie installation tooling, see [page K41](#).

System Overview

DURA-TY™ Cable Ties



Terminals

- Ideal for telecommunications, outside plant cabling applications and for use between campus buildings
- Weather Resistant Acetal provides excellent chemical and moisture resistance
- Double stainless steel, Type 302, locking bars
- High tensile strength (250 lb.) and high impact resistance
- Meets Telcordia TR-TSY-000789
- May be used with stackable cable spacer, SACS50-T100

Disconnects

Part Number	Length		Strap Width		Max. Bundle Dia.		Min. Loop Tensile Str.		Recommended Tooling	Std. Pkg. Qty.	Std. Ctn. Qty.
	In.	mm	In.	mm	In.	mm	Lbs.	N			
DT4EH-L0	13.5	343	.500	12.7	3.87	98	250	1112	GTH, GS4EH, PPTEH, ST2EH	50	1000
DT8EH-Q0	27.0	686	.500	12.7	8.00	203	250	1112		25	500

Splices



Ferrules

Part Number	Description	Length		Strap Width		Min. Loop Tensile Str.		Recommended Tooling	Std. Pkg. Qty.	Std. Ctn. Qty.
		Ft.	M	In.	mm	Lbs.	N			

Strapping, Heads and Kit

DTREH-LR0	50' reel of strapping	50.0	15	.500	12.7	250	1112	GTH, GS4EH, PPTEH, ST2EH	1	20
DTHEH-Q0	Bag of 25 cable tie heads	—	—	—	—	—	—	—	25	500
DTKEH-0	Kit containing 50' reel of strapping and 25 cable tie heads	50.0	15	.500	12.7	250	1112	GTH, GS4EH, PPTEH, ST2EH	1	20

For cable tie installation tooling, see [page K41](#).

Compression Connectors

CONTOUR-TY® Cable Ties



Crimping Tools

- Low profile head avoids snags and reduces overall bundle size
- No protrusion of cut-off protects workers' arms/hands
- Parallel-entry threads like a belt at 180° with the same performance as conventional ties
- Fully enclosed head for consistent strength
- All cross sections feature a curved tip for easy threading and handling
- Material: Nylon 6.6

Mechanical Connectors

Part Number	Length		Width		Max. Bundle Dia.		Min. Loop Tensile Str.		Recommended Tooling	Std. Pkg. Qty.	Std. Ctn. Qty.
	In.	mm	In.	mm	In.	mm	Lbs.	N			

Miniature Cross Section

CBR1M-M	4.1	104	.098	2.5	1.00	25	18	80	GTS, GS2B, PTS, PPTS, STS2	1000	50000
CBR1.5M-M	5.6	142	.098	2.5	1.50	38	18	80		1000	50000
CBR2M-M	7.2	183	.098	2.5	2.00	51	18	80		1000	25000

Intermediate Cross Section

CBR1.5I-M	5.9	150	.140	3.6	1.50	38	40	178	GTS, GS2B, PTS, PPTS, STS2	1000	25000
CBR3I-M	10.4	264	.140	3.6	3.00	76	40	178		1000	10000
CBR4I-M	13.6	345	.140	3.6	4.00	102	40	178		1000	10000

Standard Cross Section

CBR2S-M	7.6	193	.190	4.8	2.00	51	50	222	GTS, GS2B, GTH, GS4H, PTS, PPTS, STS2, STH2	1000	10000
CBR3S-M	10.8	274	.190	4.8	3.00	76	50	222		1000	5000
CBR4S-M	14.0	356	.190	4.8	4.00	102	50	222		1000	5000

Heavy-Standard Cross Section

CBR2HS-D	8.0	203	.250	6.4	2.00	51	85	378	GTH, GS4H, GS4EH, STH2, ST2EH	500	5000
----------	-----	-----	------	-----	------	----	----	-----	-------------------------------	-----	------

Light-Heavy Cross Section

CBR4LH-TL	14.6	371	.300	7.6	4.00	102	120	534	GTH, GS4H, GS4EH, PPTEH, STH2, ST2EH	250	2500
CBR6LH-C	20.9	531	.300	7.6	6.00	152	120	534		100	2000



Grounding Connectors

Support Products



Technical Info

Index

BELT-TY™ In-Line Cable Tie



- Parallel-entry cable tie that threads like a belt (180° entry)
- Low profile head avoids snags and reduces overall bundle size
- 35% lower than conventional 90° ties
- No protrusion of cut-off protects workers' arms/hands
- "Finger grip" shaped head assures positive grip during threading of tie
- Miniature to standard cross sections feature a curved tip for easy threading and handling
- Material: Nylon 6.6

Part Number	Length		Width		Max. Bundle Dia.		Min. Loop Tensile Str.		Recommended Tooling	Std. Pkg. Qty.	Std. Ctn. Qty.
	In.	mm	In.	mm	In.	mm	Lbs.	N			
Miniature Cross Section											
ILT1M-M	4.8	122	.098	2.5	1.10	28	18	80	GTS, GS2B, PTS, PPTS, STS2	1000	50000
Intermediate Cross Section											
ILT1.5I-M	5.4	137	.142	3.6	1.38	35	30	133	GTS, GS2B, PTS, PPTS, STS2	1000	25000
Standard Cross Section											
ILT2S-M	8.3	211	.190	4.8	1.88	48	50	222	GTS, GS2B, GTH, GS4H, PTS, PPTS, STS2, STH2	1000	10000
ILT3S-M	11.5	292	.190	4.8	3.00	76	50	222		1000	5000
ILT4S-M	14.7	373	.190	4.8	4.00	102	50	222		1000	5000
Light-Heavy Cross Section											
ILT4LH-TL	14.8	376	.300	7.6	4.00	102	120	534	GTH, GS4H, GS4EH, PPTEH, STH2, ST2EH	250	2500
ILT6LH-C	21.2	538	.300	7.6	6.00	152	120	534		100	2000

For cable tie installation tooling, see [page K41](#).

TAK-TY® Hook & Loop Cable Ties



HLTP / HLSP Only

- Broadest selection of sizes, styles and colors to meet your application needs
 - **Highest** tensile strength plenum-rated Hook & Loop Cable Ties in the industry
 - Adjustable, releasable and reusable hundreds of times - no tools needed
 - No risk of over-tensioning and damaging high performance cabling
- Note: Minimum 2" overlap required to achieve loop tensile rating.

Part Number	Length		Width		Max. Bundle Dia.		Min. Loop Tensile Str.		Std. Pkg. Qty.	Std. Ctn. Qty.
	In.	mm	In.	mm	In.	mm	Lbs.	N		
Loop Ties – Slot allows for pre-wrapping of bundles										
HLT2I-X0	8.0	203	.500	12.7	1.91	49	40	178	10	100
HLT3I-X0	12.0	305	.500	12.7	3.18	81	40	178	10	100
UL Listed Loop Ties+										
HLTP2I-X12	8.0	203	.500	12.7	1.91	49	40	178	10	100
HLTP3I-X12	12.0	305	.500	12.7	3.18	81	40	178	10	100
Strip Ties – Rolls perforated in convenient 6", 12" and 18" strips										
HLS1.5S-X0	6.0	152	.750	19.1	1.50	38	50	222	10	100
HLS3S-X0	12.0	305	.750	19.1	3.20	81	50	222	10	100
HLS5S-X0	18.0	457	.750	19.1	5.00	127	50	222	10	100
UL Listed Strip Ties+										
HLSP1.5S-X12	6.0	152	.750	19.1	1.50	38	50	222	10	100
HLSP3S-X12	12.0	305	.750	19.1	3.20	81	50	222	10	100
HLSP5S-X12	18.0	457	.750	19.1	5.00	127	50	222	10	100
15' & 75' Rolls – Can be cut to desired length, eliminating waste										
HLM-15R0	180.0	4,572	.330	8.4	Various	Various	18	80	1	10
HLS-15R0	180.0	4,572	.750	19.1	Various	Various	50	222	1	10
HLS-75R0	900.0	22,860	.750	19.1	Various	Various	50	222	1	10

+Also available in Black (-X0), which has an 18 lb. (80N) minimum loop tensile strength.

Color Chart		
Color	Part No. Suffix	Example
Black	0	HLT2I-X0
Red	2	HLT2I-X2
Orange	3	HLT2I-X3
Yellow	4	HLT2I-X4
Green	5	HLT2I-X5
Blue	6	HLT2I-X6
Gray	8	HLT2I-X8
White	10	HLT2I-X10
Maroon	12	HLTP2I-X12

System Overview

Terminals

Disconnects

Splices

Ferrules

Compression Connectors

Crimping Tools

Mechanical Connectors

Grounding Connectors

Support Products

Technical Info

Index

System Overview

TAK-TAPE™ Hook & Loop Strips



Terminals

- **Strongest**, low profile material in the industry – thin and flexible to quickly wrap around bundles
- Cost effective for general purpose bundling
- Adjustable, releasable and reusable
- Large continuous roll you can cut to size

- Handy, reusable plastic case (TTS20) keeps material clean

Note: Minimum 2" overlap required to achieve loop tensile rating.

Disconnects

Part Number	Length		Width		Max. Bundle Dia.		Min. Loop Tensile Str.		Std. Pkg. Qty.	Std. Ctn. Qty.
	Ft.	M	In.	mm	In.	mm	Lbs.	N		
TTS-20R0	20	6	.750	19.1	Various	Various	40	178	1	10
TTS-35RX0	35	11	.750	19.1	Various	Various	40	178	1	10

Std. Pkg. Qty. of TTS-35RX0 denotes 1 package of ten 35' rolls.

Splices

NEW! ULTRA-CINCH™ Hook & Loop Ties



Ferrules

- **Exclusive** material with hooks & loops on same side allows user to secure a greater range of bundle diameters, including smaller bundles
- Low profile contoured cinch ring reduces overall bundle size
- Releasable and reusable hundreds of times which is ideal for applications requiring frequent moves, adds or changes
- Soft hook and loop material protects against cable damage, such as over-tensioning of high performance UTP and fiber optic cables

- Tapered tip threads easily for snag-free threading to speed installation time
- Sturdy brass grommet (on UGCTC and UGCTE styles) resists pullout, and allows cable bundles to be securely fastened to surfaces
- **PANDUIT®** recommends flat-head screws for use in grommet applications

Note: Minimum 2" overlap required to achieve loop tensile rating

Compression Connectors

Crimping Tools



Mechanical Connectors

Grounding Connectors

Part Number	Length		Width		Max. Bundle Dia.		Min. Loop Tensile Str.		Std. Pkg. Qty.	Std. Ctn. Qty.
	In.	mm	In.	mm	In.	mm	Lbs.	N		
Cinch Ties										
UCT3S-X0	12.0	305	.850	21.6	3.00	76	50	222	10	100
UCT5S-X0	18.0	457	.850	21.6	5.00	127	50	222	10	100

Center Mount Grommet

UGCTC3S-X0‡	12.0	305	.850	21.6	3.00	76	50	222	10	100
UGCTC5S-X0‡	18.0	457	.850	21.6	5.00	127	50	222	10	100

End Mount Grommet

UGCTE3S-X0‡	12.0	305	.850	21.6	3.00	76	50	222	10	100
UGCTE5S-X0‡	18.7	475	.850	21.6	5.00	127	50	222	10	100

‡1/4" (6mm) diameter mounting hole.

Screw Information

Part Number	Part Description	Std. Pkg. Qty.	Std. Ctn. Qty.
UCTGS1224-X	12-24 UNC x 5/8mm (.625") Flat Head Phillips Screw	10	100
UCTGSM5-X	M5 x 16mm Flat Head Phillips Screw	10	100
UCTGSM6-X	M6 x 16mm Flat Head Phillips Screw	10	100

Use of above screws ensures screw head is mounted flush with grommet.

Support Products

Color Chart		
Color	Part No. Suffix	Example
Black	0	UCT3S-X0
Red	2	UCT3S-X2
Orange	3	UCT3S-X3
Yellow	4	UCT3S-X4
Green	5	UCT3S-X5
Blue	6	UCT3S-X6
Gray	8	UCT3S-X8
White	10	UCT3S-X10

Technical Info

Index

Cable Tie Installation Tools



Hand-Operated Tools — Tool-Controlled Tension and Cut-Off

- Tool-controlled tension and cut-off provides consistent results and speeds installation to lower installed cost
- Ergonomic tools (GTS & GTH) are lightweight and comfortable to use, reducing operator fatigue
- Tools provide flush cut-off of cable tie, which limits exposure to sharp edges
- Tension adjustment conveniently located and easy to change
- Replacement blades available

Part Number	Part Description	Std. Pkg. Qty.
GTS	Installs Subminiature, Miniature, Intermediate and Standard cross section cable ties. Qualified Product Listed per Mil. Std. MS90387-1 and Mil. Spec. MIL-T-81306A. Color identification: black trigger handle Body: gray plastic housing with black selector knob Weight: 8.8 oz. (249g)	1
GTH	Installs Standard, Heavy-Standard, Light-Heavy and Heavy cross section cable ties. Color identification: red trigger handle Body: gray plastic housing with red selector knob Weight: 11.2 oz. (318g)	1
GS4EH	Installs Light-Heavy, Heavy and Extra-Heavy cross section cable ties. Color identification: blue trigger handle Body: gray metal housing with blue selector knob Weight: 16 oz. (454g)	1

Cable Tie Installation Tools for use with PANDUIT® cable ties on [pages K36 to K39](#).

Hand Operated Tools — Installer-Controlled Tension and Cut-Off

- Economical series of tools for maintenance or construction applications
- Operator-controlled tension and cut-off
- Excellent tool for low volume applications



Part Number	Part Description	Std. Pkg. Qty.
STS2	Installs Miniature, Intermediate and Standard cross section cable ties. Install cable tie around bundle and tension tie by squeezing tool handle. Reduce tension slightly and twist tool 1/4 turn in either direction to cut off excess cable tie. Color identification: black Weight: 2.5 oz. (71g)	1
STH2	Installs Standard, Heavy-Standard, Light-Heavy and Heavy cross section cable ties. Inexpensive, maintenance-free, all purpose tool. Ergonomic handle design and short handle span. Top loading feature for right or left-handed users. Install cable tie around bundle and tension tie by squeezing tool handle. Reduce tension slightly and twist tool 1/4 turn either direction to cut off excess cable tie. Color identification: red Weight: 2.5 oz. (71g)	1
ST2EH	Installs Light-Heavy, Heavy and Extra-Heavy cross section cable ties. Durable all steel construction with comfortable rubber handles. Install cable tie around bundle and tension tie by squeezing tool handle. Reduce tension slightly and twist tool 1/4 turn either direction to cut off excess cable tie. Color identification: black Weight: 16 oz. (454g)	1

Cable Tie Installation Tools for use with PANDUIT® cable ties on [pages K36 to K39](#).

System Overview

Terminals

Disconnects

Splices

Ferrules

Compression Connectors

Crimping Tools

Mechanical Connectors

Grounding Connectors

Support Products

Technical Info

Index

System
Overview

Terminals

Disconnects

Splices

Ferrules

Compression
Connectors

Crimping
Tools

Mechanical
Connectors

Grounding
Connectors

Support
Products

Technical
Info

Index

NOTES

TECHNICAL SPECIFICATION AND SELECTION INFORMATION

The following pages provide information helpful in specifying *PANDUIT*® Power and Grounding Connectors and selecting the appropriate connector and tooling for your applications.

TESTING AGENCIES AND TEST STANDARDS

UNDERWRITERS LABORATORIES, INC.



Is an independent, not-for-profit safety testing and certification organization based in the United States. Underwriters Laboratories, Inc. Standards applicable to specified *PANDUIT*® *PAN-TERM*® Terminals and *PAN-LUG*™ Power Connectors:

- ◆ **UL 486A Wire Connectors and Soldering Lugs for Use with Copper Conductors** — Covers pressure wire connectors and soldering lugs for use with copper conductors according to the National Electrical Code NFPA 70.
- ◆ **UL 486B Wire Connectors for Use with Aluminum Conductors**
- ◆ **UL 467 Grounding and Bonding Equipment**
- ◆ **UL 310 Electrical Quick-Connect Terminals**
- ◆ **UL 94 Test for Flammability of Plastic Materials for Parts in Devices and Appliances**

CANADIAN STANDARDS ASSOCIATION



Canadian Standards Association is a not-for-profit membership based association serving business, industry, government, and consumers in Canada and the global market place. C.S.A. works in Canada and around the world to develop standards that enhance public safety and health.

Canadian Standards Association standards that are applicable to specified *PANDUIT*® *PAN-TERM*® Terminals and *PAN-LUG*™ Power Connectors:

- ◆ **C22.2 NO. 65-03 Wire Connectors**
- ◆ **C22.2 NO. 41-M1987 (R1999) Grounding and Bonding Equipment**

NATIONAL ELECTRICAL MANUFACTURERS ASSOCIATION NEMA

NEMA is the largest trade association in the U.S. representing electro-industry manufacturers. NEMA develops industry standards that are in the best interest of the industry and users of its products. NEMA standards for electrical power connector for substations covers uninsulated connectors and bus bar supports which are made of metal and intended for use in substations. Included in the standard are manufacturing standards for bolt hole sizes and spacings for terminal connectors with single tangs. *PANDUIT*® offers connectors that meet NEMA manufacturing standards and these are specially noted as listed within this catalog.

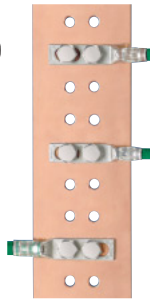

TELECOMMUNICATIONS INDUSTRY ASSOCIATION TIA



The Telecommunications Industry Association is a leading U.S. non-profit trade association serving the communications and information technology industry. TIA represents providers of communications and information technology products and services for the global marketplace through its core competencies in standards development.

ALLIANCE FOR TELECOMMUNICATIONS INDUSTRY SOLUTIONS ATIS



ATIS is a technical planning and standards development organization that is committed to rapidly developing and promoting technical and operations standards for the communications and related information technologies industry worldwide using a pragmatic, flexible and open approach. Over 1,200 participants from more than 400 communications companies are active in ATIS' 22 industry committees, and its Incubator Solutions Program. www.atis.org

- ◆ **J-STD-607-A-2002, Commercial Building Grounding (Earthing) and Bonding Requirements for Telecommunications** is jointly developed by TIA/EIA and ATIS' technical committee T1E1. This document is available on the ATIS Document Center at www.atis.org.

Adhering to the grounding principles outlined in J-STD-607-A-2002 helps ensure that telecommunications equipment and systems operate reliably. As stated in J-STD-607-A-2002, the preferred means of connecting conductors to busbars is by using two-hole irreversible compression lugs listed by a nationally recognized testing laboratory (NRTL) such as UL. The *PANDUIT*® *PAN-LUG*™ line of copper compression connectors meets these requirements, in all of the barrel sizes specified by the 607 standard.

NEBS LEVEL 3 APPROVAL AS TESTED BY TELCORDIA TECHNOLOGIES

PANDUIT® is the first in the industry to have a system of copper compression lugs and splices (#8 AWG - 1,000 kcmil) and crimping tools physically and rigorously tested by Telcordia Technologies to meet Network Equipment-Building Systems (NEBS) Level 3 compliance.

Telcordia Technologies, formerly known as Bellcore, serves as the testing agency for the Regional Bell Operating Companies.

NEBS was developed by Bellcore and is currently maintained by Telcordia Technologies. NEBS was developed to standardize requirements for Central Office Equipment and to develop criteria for personal safety, protection of property and operational continuity.

NEBS level 3 Criteria is the minimum level of environmental compatibility needed to provide maximum assurance of equipment operability within the network facility environment. The Level 3 Criteria is the highest assurance of product operability. Products that meet NEBS level 3 Criteria are suited for equipment applications which demand minimal service interruptions over the life span of the equipment.

System Overview

Terminals

Disconnects

Splices

Ferrules

Compression Connectors

Crimping Tools

Mechanical Connectors

Grounding Connectors

Support Products

Technical Info

Index

System Overview

Tooling Selection Guide for PANDUIT® Terminals, Splices and Disconnects

Terminals

See Crimping Tools Tab — Section G

Disconnects

Splices

Ferrules

Compression Connectors

Crimping Tools

Mechanical Connectors

Grounding Connectors

Support Products

Technical Info

Index

PANDUIT® Terminal Series	Terminal Description	Std. Wire Range (AWG)	Wire Strip Length (In.) [+1/32;-0]	See Crimping Tools Tab — Section G																			
				Plier Tools				Controlled Cycle Hand Tools										Crimp Heads for Pneumatic CT-600 Tool				Mechanical	
				CT-100	CT-160	CT-200	CT-260	CT-300-1	CT-310	CT-400	CT-460	CT-1014	CT-1015	CT-1525	CT-1550	CT-1551	CT-1570	CT-1701	CT-500CH	CT-520CH	CT-550CH	CT-570CH	CT-720
BS	Non-Insulated Butt Splices	26-22	1/4	X		X																	
		22-18	9/32	X	X	X	X								X						X		
		16-14	9/32	X	X	X	X								X						X		
		12-10	9/32	X	X	X	X								X	X					X		
BSH	Heat Shrink Splices	22-18	5/16						X														
		16-14	5/16						X														
		12-10	5/16						X														
BSN	Nylon Insulated Butt Splices	26-22	1/4	X									X					X					
		22-18	9/32	X	X		X		X				X	X			X						
		16-14	9/32	X	X		X		X	X			X	X			X						
		12-10	9/32	X	X		X		X				X	X					X				
BSV	Vinyl Insulated Butt Splices	22-18	5/16	X	X	X	X		X				X	X			X		X				
		16-14	5/16	X	X	X	X		X	X			X	X			X		X				
		12-10	5/16	X	X		X		X				X	X					X				
D, DR	Non-Insulated Sleeved Barrel Disconnects (Includes Right Angle Disc)	22-18	9/32	X	X	X	X								X						X		
		16-14	9/32	X	X	X	X								X						X		
		12-10	9/32	X	X	X	X								X	X					X		
D-B	Non-Insulated Butted Seam Female Disconnects	22-18	9/32	X																			
		16-14	9/32	X		X																	
D-M	Non-Insulated Male Blade Adapters	22-18	9/32	X	X	X	X								X						X		
		16-14	9/32	X	X	X	X								X						X		
D-M	Non-Insulated Male Disc.	12-10	9/32	X		X	X							X	X						X		
D-MB, DR-B	Non-Insulated Right Angle Female Disc. & Non-Insulated Male Butted Seam Disc.	22-18	9/32	X																			
		16-14	9/32	X		X																	
DNF	Nylon, Funnel Entry, Barrel Insulated Disc. (not .110/.111)	22-18	9/32	X	X		X		X								X						
		16-14	9/32	X	X		X		X	X			X	X			X		X				
DNF-110, DNF-111	Nylon, Funnel Entry Barrel Insulated Disconnect, .110/.111 Tab Size	22-18	7/32	X									X				X	X					
		16-14	9/32	X	X								X	X									
DNF-FI	Nylon, Fully Insulated Disconnect	22-18	9/32	X	X		X						X	X	X		X		X				
		16-14	9/32	X	X		X						X	X			X		X				
		12-10	3/8	X	X		X			X			X	X					X				
DPF-FI	Premium Nylon, Fully Ins. Disconnect	12-10	3/8	X	X		X			X			X	X					X				
DNF-FIB, DNF-FIM, DNF-FIMB, DPF-FIB, DPF-FIMB, DNF-LPB, DPF-LPB	Nylon & Premium Grade Nylon, Fully Insulated, Funnel Entry, Male/Female Couplers (not .110/.111)	22-18	9/32	X									X					X					
		16-14	9/32	X									X					X					
		12-10	3/8																				
DNF-FIB, DPF-FIB	Nylon & Premium Grade Nylon, Fully Insulated, Funnel Entry Disconnect, 110/.111 Tab Size	22-18	7/32										X					X					
		16-14	9/32	X																			
DNF-FIBX	Nylon, Expanded Wire Entry, Fully Insulated	22-18	9/32	X									X										
		16-14	9/32	X																			

Tooling Selection Guide for PANDUIT® Terminals, Splices and Disconnects (continued)

See Crimping Tools Tab — Section G

PANDUIT® Terminal Series	Terminal Description	Std. Wire Range (AWG)	Wire Strip Length (In.) [+1/32;-0]	See Crimping Tools Tab — Section G																Mechanical
				Plier Tools				Controlled Cycle Hand Tools										Crimp Heads for Pneumatic CT-600 Tool		
				CT-100	CT-160	CT-200	CT-260	CT-300-1	CT-310	CT-400	CT-460	CT-1014	CT-1015	CT-1525	CT-1550	CT-1551	CT-1570	CT-1701	CT-500CH	
DNF-M	Nylon Insulated, Funnel Entry, Barrel Insulated, Male Disconnects	22-18	9/32	X													X	X		
		16-14	9/32	X	X		X						X	X			X	X		
		12-10	9/32	X	X		X	X					X	X					X	
		16-14	11/32	X			X		X				X	X						
DNFR-B	Nylon Pre-insulated, Right Angle Disconnects	22-18	9/32	X									X							
		16-14	9/32	X									X							
DNFR-FIB	Nylon Butted Seam, Right Angle Disconnects	22-18	11/32					X												
		16-14	11/32					X												
DNG-FB	SUPRA GRIP™ Nylon, Fully Insulated Disc., (Except DNG14-187FB & DNG14-188FB)	22-18	1/4										X							
		16-14	1/4										X							
DNG-FL	DISCO-LOK™ Nylon, Fully Insulated Disconnects	22-18	1/4									X								
		16-14	1/4									X								
DNH	Heat Shrink Disconnects	22-18	9/32					X												
		16-14	9/32					X												
		12-10	9/32					X												
DV	Vinyl Barrel Insulated Sleeved Disconnects	12-10	9/32	X									X	X				X		
DV-B	Vinyl Insulated, Butted Seam Disconnects	22-18	9/32	X									X					X		
		16-14	9/32	X									X					X		
DV-M	Vinyl Barrel Insul. Male Blade Adapters	22-18	9/32	X	X		X		X				X	X			X	X		
		16-14	9/32	X	X		X		X	X			X	X			X	X		
DV-M	Vinyl Insulated Male Disconnects	12-10	9/32	X			X												X	
DV-MB	Vinyl Insul. Butted Seam Male Disconnects	22-18	9/32	X	X		X		X				X	X			X	X		
		16-14	9/32	X	X		X		X	X			X	X			X	X		
DV-P	Vinyl Insulated Piggyback Disconnects	22-18	1/4	X	X		X						X	X			X	X		
		16-14	1/4	X	X		X						X	X			X	X		
DVF	Vinyl Funnel Entry Barrel Insulated Female Disconnect	22-18	9/32	X			X						X	X			X	X		
		16-14	9/32	X			X						X	X			X	X		
J	Non-Insulated Wire Joints	J214-312	18-12	1/2	X		X													
		J318-412	18-10	1/2	X		X													
		J216-410	16-10	3/4				X												
JN	Nylon Insulated Wire Joints	JN224-318	24-14	7/16	X	X		X					X	X			X	X		
		JN218-216	22-14	7/16	X	X			X				X	X			X	X		
		JN418-212	18-12	1/2	X	X				X				X	X				X	
		JN314-412	16-10	5/8				X												X
P-HDR	Non-Insulated Heavy Duty Rings	16-12	9/32	X	X	X	X								X	X				X
P-P	Non-Insulated Pin Terminals	22-18	9/32	X	X	X	X								X					X
		16-14	9/32	X	X	X	X								X					X
		12-10	9/32	X	X	X	X								X	X				X
P-R	Non-Insulated Large Ring Terminals	8	3/8													X				
		6	7/16													X				
		4	1/2													X				
		2	1/2													X				

Tool selection chart continues on page L4

System Overview

Terminals

Disconnects

Splices

Ferrules

Compression Connectors

Crimping Tools

Mechanical Connectors

Grounding Connectors

Support Products

Technical Info

Index

System Overview

Tooling Selection Guide for PANDUIT® Terminals, Splices and Disconnects (continued)

See Crimping Tools Tab — Section G

Terminals	PANDUIT® Terminal Series	Terminal Description	Std. Wire Range (AWG)	Wire Strip Length (In.) [+1/32;-0]	See Crimping Tools Tab — Section G																Mechanical			
					Plier Tools				Controlled Cycle Hand Tools										Crimp Heads for Pneumatic CT-600 Tool					
					CT-100	CT-160	CT-200	CT-260	CT-300-1	CT-310	CT-400	CT-460	CT-1014	CT-1015	CT-1525	CT-1550	CT-1551	CT-1570	CT-1701	CT-500CH		CT-520CH	CT-550CH	CT-570CH
Disconnects	P-R, P-F, P-LF, P-SLF, P-FF	Non-Ins. Rings, Forks, Locking Forks, Short Locking Forks, Flanged Forks	26-22	3/16	X		X																	
			22-18	9/32	X	X	X	X								X							X	
			16-14	9/32	X	X	X	X								X								X
			12-10	9/32	X	X	X	X								X	X							X
Splices	P-RHT6	High Temperature Rings	22-18	9/32	X	X	X	X								X						X		
			16-14	9/32	X	X	X	X								X							X	
			12-10	9/32	X	X	X	X								X	X						X	
Ferrules	PH	Heat Shrink Terminals	22-18	5/16					X															
			16-14	5/16						X														
			12-10	5/16						X														
Compression Connectors	PN-R, PN-RX, PN-F, PN-LF, PN-FF, PNF-R, PNF-F, PNF-LF	Nylon & Nylon Funnel Entry Forks, Locking Forks, Flanged Forks (Includes Expanded Insul.)	26-22	3/16	X									X					X					
			22-18	7/32	X	X		X		X					X	X			X		X			
			16-14	7/32	X	X		X		X	X				X	X			X		X			
			12-10	9/32	X	X		X		X	X				X	X			X		X			
Crimping Tools	PS	Non-Insulated Parallel Splices	22-18	5/16	X		X	X																
			20-16	5/16	X		X	X																
			14-12	7/16	X		X	X																
Mechanical Connectors	PSN	Nylon Insulated Parallel Splices	22-18	5/16										X										
			20-16	5/16	X	X		X							X									
			14-12	7/16																				
Grounding Connectors	PT-R	TEFZEL* Rings	22-18	7/32	X	X		X						X	X			X		X				
			16-14	7/32	X	X		X		X	X				X	X			X		X			
			12-10	9/32	X	X		X		X	X				X	X			X		X			
Support Products	PV-HDR, PV-HDRX	Vinyl Insulated Heavy Duty Rings	16-12	5/16						X				X	X					X				
			PV-LF, PV-LFX	Vinyl Insulated Locking Forks (includes Expanded Insul.)	22-18	5/16	X	X		X						X	X			X		X		
					16-14	5/16	X	X		X		X	X				X	X			X		X	
12-10	5/16	X			X		X		X	X				X	X			X		X				
Technical Info	PV-P	Vinyl Insul. Pin Terminals	22-18	5/16	X	X		X						X	X			X		X				
			16-14	5/16	X	X		X		X	X				X	X			X		X			
			12-10	5/16	X	X		X		X	X				X	X			X		X			
			8	3/8																				X‡
Index	PV-R, PV-RX	Vinyl Insulated Large Ring Terminals	6	7/16																			X‡	
			4	1/2																			X‡	
			2	1/2																			X‡	
			PV-SLF	Vinyl Insul. Short Locking Forks	22-18	5/16						X					X	X			X		X	
16-14	5/16								X	X				X	X			X		X				
12-10	5/16								X	X				X	X			X		X				

*TEFZEL is a registered trademark of E.I. DuPont de Nemours Co.
 ‡Use Die CD--720PV8-2.

Tooling Selection Guide for PANDUIT® Tubular Ring Terminals

See Crimping Tools Tab — Section G

Tooling	See Crimping Tools Tab — Section G					
	CT-1700	CT-720	CT-930, CT-930CH, CT-920, CT-920CH, CT-2920, CT-940CH	CT-980, CT-980CH, CT-2950, CT-2980	CT-2001	
PANDUIT® Part Number	PANDUIT® Die Part Number Die Index Number (Number of Crimps)					
S8-10R-Q	P21 (2)	CD-720-1	CD-920-8	—	CD-2001-8	
S8-14R-Q		P21	P21		P21	P21
S8-56R-Q		(1)	(1)		(1)	(1)
S8-38R-Q						
S6-10R-E	P24 (2)	CD-720-1	CD-920-6	—	CD-2001-6	
S6-14R-E		P24	P24		P24	P24
S6-56R-E		(1)	(1)		(1)	(1)
S6-38R-E						
S4-10R-E	P29 (2)	CD-720-1	CD-920-4	STD (1)	CD-2001-4	
S4-14R-E		P29	P28		P29	P29
S4-56R-E		(1)	(1)		(1)	(1)
S4-38R-E						
S2-10R-X	P37 (3)	CD-720-2	CD-920-1	STD (1)	CD-2001-1	
S2-14R-X		P37	P37		P37	P37
S2-56R-X		(1)	(1)		(1)	(1)
S2-38R-X						
S2-12R-X	—	CD-720-2	CD-920-1/0	STD (1)	CD-2001-1/0	
S1/0-14R-X		P42	P42		P42	P42
S1/0-56R-X		(1)	(1)		(1)	(1)
S1/0-38R-X						
S1/0-12R-X	—	CD-720-2	CD-920-2/0	STD (1)	CD-2001-2/0	
S2/0-14R-X		P45	P45		P45	P45
S2/0-56R-X		(2)	(1)		(1)	(2)
S2/0-38R-X						
S2/0-76R-X	—	CD-720-2	CD-920-3/0	STD (1)	CD-2001-3/0	
S2/0-12R-X		P50	P50		P50	P50
S3/0-14R-5		(2)	(1)		(1)	(2)
S3/0-56R-5						
S3/0-38R-5	—	CD-720-3	CD-920-4/0	STD (1)	CD-2001-4/0	
S3/0-76R-5		P54	P54		P54	P54
S3/0-12R-5		(2)	(1)		(1)	(2)
S4/0-38R-5						
S4/0-76R-5	—	CD-720-3	CD-920-250	STD (1)	CD-2001-250	
S4/012R-5		P62	P62		P62	P62
S250-56R-5		(2)	(1)		(1)	(2)
S250-38R-5						
S250-76R-5	—	CD-720-3		STD (1)		
S250-12R-5		P62			P62	P62

Tooling Selection Guide for PANDUIT® Ferrules

See Crimping Tools Tab — Section G

PANDUIT® Ferrule Series	Ferrule Description	Wire Range (AWG)	Wire Range (mm²)	Wire Strip Length	Controlled Cycle Hand Tools				
					CT-1002	CT-1003	CT-1004	CT-1005	CT-1006
F	Non-Insulated Ferrules	24-18	.25 - 1.00	See specific part listing — Pgs. E4-E7	X	X			
		16-14	1.50 - 2.00		X	X			
		12-10	4.00 - 6.00		X	X			
		8-6	10.0 - 16.0			X	X		
		4-2	25.0 - 35.0					X	
		1	50.0						X
FSD, FSF	Insulated Single Wire Ferrules (DIN or French color code)	26-18	.41 - 1.00	See specific part listing — Pgs. E4-E7	X	X			
		16-14	1.50 - 2.00		X	X			
		12-10	4.00 - 6.00		X	X			
		8-6	10.0 - 16.0			X	X		
		4-2	25.0 - 35.0					X	
		1	50.0						X
FTD	Insulated Twin Wire Ferrules	22-18	.50 - 1.00	See specific part listing — Pgs. E4-E7	X	X			
		16-14	1.50 - 2.00		X	X			
		12-10	4.00 - 6.00			X	X		

System Overview

For use with Copper Conductors

Installation Tooling and Die Selections for: Types LCAS & SCSS

Terminals

Disconnects

Splices

Ferrules

Compression Connectors

Crimping Tools

Mechanical Connectors

Grounding Connectors

Support Products

Technical Info

Index

PANDUIT® Part Number				PANDUIT® (See Crimping Tools Tab — Section G)					Thomas & Betts		
				CT-1700 ^①	CT-720	CT-920, CT-920CH, CT-930, CT-930CH, CT-2930, CT-930LPCH, CT-2931, CT-2940**, CT-2920, CT-940CH**	CT-980, CT2980, CT-980CH, CT-2981, CT-980LPCH, CT-2950***	CT-2001, CT-2002	TBM20S, TBM25S	TBM5	TBM8
Lug	Splice	Std. Wire Size	Wire Strip Length (In.)	Die Part Number / Color Code & Die Index Number / (Number Of Crimps)							
LCAS8	SCSS8	8 AWG	7/16	Red P21 (2)	CD-720-1 Red P21 (1)	CD-920-8 Red P21 (1)	—	CD-2001-8 Red P21 (1)	Red (2)	Red (1)	Red (1)
LCAS6	—	6 AWG	1/2	Blue P24 (2)	CD-720-1 Blue P24 (1)	CD-920-6 Blue P24 (1)	STD (1)	CD-2001-6 Blue P24 (1)	Blue (2)	Blue (1)	Blue (1)
—	SCSS6		7/16								
LCAS4	—	4 AWG	9/16	Gray P29 (2)	CD-720-1 Gray P29 (1)	CD-920-4 Gray P29 (1)	STD (1)	CD-2001-4 Gray P29 (1)	Gray (2)	Gray (1)	Gray (1)
—	SCSS4		7/16								
LCAS2	SCSS2	2 AWG	9/16	Brown P33 (2)	CD-720-1 Brown P33 (1)	CD-920-2 Brown P33 (1)	STD (1)	CD-2001-2 Brown P33 (1)	Brown (2)	Brown (1)	Brown (1)
LCAS1	—	1 AWG	5/8	Green P37 (3)	CD-720-2 Green P37 (1)	CD-920-1 Green P37 (1)	STD (1)	CD-2001-1 Green P37 (1)	—	Green (1)	Green (1)
—	SCSS1		11/16								
LCAS1/0	SCSS1/0	1/0 AWG	11/16	—	CD-720-2 Pink P42 (1)	CD-920-1/0 Pink P42 (1)	STD (1)	CD-2001-1/0 Pink P42 (1)	—	Pink (1)	Pink (1)
LCAS2/0	SCSS2/0	2/0 AWG	3/4	—	CD-720-2 Black P45 (2)	CD-920-2/0 Black P45 (1)	STD (1)	CD-2001-2/0 Black P45 (2)	—	Black (2)	Black (2)
LCAS3/0	—	3/0 AWG	13/16	—	CD-720-2 Orange P50 (2)	CD-920-3/0 Orange P50 (1)	STD (1)	CD-2001-3/0 Orange P50 (2)	—	Orange (2)	Orange (2)
—	SCSS3/0		3/4								
LCAS4/0	—	4/0 AWG	15/16	—	CD-720-3 Purple P54 (2)	CD-920-4/0 Purple P54 (1)	STD (1)	CD-2001-4/0 Purple P54 (2)	—	Purple (2)	Purple (2)
—	SCSS4/0		13/16								
LCAS250	SCSS250	250 kcmil	1-1/16	—	CD-720-3 Yellow P62 (2)	CD-920-250 Yellow P62 (1)	STD (1)	CD-2001-250 Yellow P62 (2)	—	Yellow (2)	Yellow (2)

*Half width dies.

**CD-920 Dies can be used with CT-940CH and CT-2940 tools with the CT-940-AD adapter.

① CT-1700 crimp die pockets are integrated into the tool frame.

② Minimum size: 4 AWG Lugs and Splices.

For use with
Copper
Conductors

Installation Tooling and Die Selections for: Types LCAS & SCSS (continued)

Thomas & Betts				Burdndy					Penn-Union	Greenlee
TBM12, 13642M	TBM15, TBM15I, TBM15BSCR	TBM8-750M-I, TBM8-750, TBM8-750BSCR, TBM750BSCR®	TBM14M, TBM14BSCR, BPLT14BSCR, 13100A	Y2MR, Y1MR, Y1MR	MY29	Y35, Y35BH, Y39, Y39BH, Y45, Y46, Y750, Y750-2, Y750BH, Y750BH-2, Y750HS, PAT750, BAT750, BAT35	Y644M, Y644HS, Y644MBH, PAT644, BAT644	VC6	TDY-1	1989
Die Part Number / Color Code & Die Index Number / (Number Of Crimps)										
21 (1)	21 (1)	STD (1)	21 (1)	Red (2)	#8 (1)	U8CRT Red 49 (1)	—	—	—	—
24 (1)	24 (1)	STD (1)	24 (1)	Blue (2)	#6 (1)	U5CRT Blue 7 (1)	STD (1)	STD (1)	—	—
29 (1)	29 (1)	STD (1)	29 (1)	Gray (2)	#4 (1)	U4CRT Gray 8 (1)	STD (1)	STD (1)	STD (1)	STD (1)
33 (1)	33 (1)	STD (1)	33 (1)	Brown (2)	#2 (1)	U2CRT Brown 10 (1)	STD (1)	STD (1)	STD (1)	STD (1)
37 (1)	37 (1)	STD (1)	37 (1)	—	#1 (1)	U1CRT Green 11 (1)	STD (1)	STD (1)	STD (1)	STD (1)
42 (1)	42H* (2)	STD (1)	42H* (2)	—	1/0 (1)	U25RT Pink 12 (1)	STD (1)	STD (1)	STD (1)	STD (1)
45 (1)	45 (1)	STD (1)	45 (1)	—	2/0 (1)	U26RT Black 13 (1)	STD (1)	STD (1)	STD (1)	STD (1)
50 (1)	50 (1)	STD (1)	50 (1)	—	3/0 (1)	U27RT Orange 14 (1)	STD (1)	STD (1)	STD (1)	STD (1)
54 (1)	54H* (2)	STD (1)	54H* (2)	—	4/0 (1)	U28RT Purple 15 (1)	STD (1)	STD (1)	STD (1)	STD (1)
62 (1)	62 (1)	STD (1)	62 (1)	—	250 (1)	CD-920-250 Yellow P62 (1)	STD (1)	CD-2001-250 Yellow P62 (2)	—	Yellow (2)

*Half width dies.

**CD-920 Dies can be used with CT-940CH and CT-2940 tools with the CT-940-AD adapter.

① CT-1700 crimp die pockets are integrated into the tool frame.

② Minimum size: 4 AWG Lugs and Splices.

System Overview

Terminals

Disconnects

Splices

Ferrules

Compression Connectors

Crimping Tools

Mechanical Connectors

Grounding Connectors

Support Products

Technical Info

Index

System Overview

For use with Copper Conductors

Installation Tooling and Die Selections for: Types LCA, LCA_N, LCD, LCD_N and SCS

Terminals

Disconnects

Splices

Ferrules

Compression Connectors

Crimping Tools

Mechanical Connectors

Grounding Connectors

Support Products

Technical Info

Index

				PANDUIT® (See Crimping Tools Tab — Section G)					Thomas & Betts		
PANDUIT® Part Number	Std. Wire Size	Wire Strip Length (In.)	CT-1700 ^④	CT-720	CT-920, CT-920CH, CT-930, CT-930CH, CT-930LPCH [®] , CT-2920, CT-2930, CT-2931, CT-940CH ^{**} , CT-2940 ^{**}	CT-980, CT-2980, CT-980LPCH [®] , CT-980CH, CT-2950 ^① , CT-2981	CT-2001, CT-2002	TBM20S, TBM25S	TBM5, TBM8	TBM12, 13642M	
			Die Part Number / Color Code & Die Index Number / (Number of Crimps)								
LCA8 LCA _N 8 LCD8 LCD _N 8 SCS8	8 AWG	9/16 1-1/16	Red P21 (2)	CD-720-1 Red P21 (1)	CD-920-8 Red P21 (1)	—	CD-2001-8 Red P21 (1)	Red 21 (2)	Red 21 (1)	Red 21 (1)	
LCA6 LCA _N 6 LCD6 LCD _N 6 SCS6	6 AWG	13/16	Blue P24 (2)	CD-720-1 Blue P24 (1)	CD-920-6 Blue P24 (1)	—	CD-2001-6 Blue P24 (1)	Blue 24 (2)	Blue 24 (1)	Blue 24 (1)	
LCA4 LCA _N 4 LCD4 LCD _N 4 SCS4	2 AWG SOL 4-3 AWG STR	13/16	Gray P29 (2)	CD-720-1 Gray P29 (1)	CD-920-4 Gray P29 (1)	STD (1)	CD-2001-4 Gray P29 (1)	Gray 29 (2)	Gray 29 (1)	Gray 29 (1)	
LCA2 LCA _N 2 LCD2 LCD _N 2 SCS2	2 AWG	7/8	Brown P33 (2)	CD-720-1 Brown P33 (1)	CD-920-2 Brown P33 (1)	STD (1)	CD-2001-2 Brown P33 (1)	Brown 33 (2)	Brown 33 (1)	Brown 33 (1)	
LCA1 LCA _N 1 LCD1 LCD _N 1 SCS1	1 AWG	7/8	Green P37 (3)	CD-720-2 Green P37 (1)	CD-920-1 Green P37 (1)	STD (1)	CD-2001-1 Green P37 (1)	—	Green 37 (1)	Green 37 (1)	
LCA1/0 LCA _N 1/0 LCD1/0 LCD _N 1/0 SCS1/0	1/0 AWG	15/16 7/8	—	CD-720-2 Pink P42 (1)	CD-920-1/0 Pink P42 (1)	STD (1)	CD-2001-1/0 Pink P42 (1)	—	Pink 42 (1)	Pink 42 (1)	
LCA2/0 LCA _N 2/0 LCD2/0 LCD _N 2/0 SCS2/0	2/0 AWG	1 15/16	—	CD-720-2 Black P45 (2)	CD-920-2/0 Black P45 (2)	STD (1)	CD-2001-2/0 Black P45 (2)	—	Black 45 (2)	Black 45 (1)	
LCA3/0 LCA _N 3/0 LCD3/0 LCD _N 3/0 SCS3/0	3/0 AWG	1-1/8 1	—	CD-720-2 Orange P50 (2)	CD-920-3/0 Orange P50 (2)	STD (1)	CD-2001-3/0 Orange P50 (2)	—	Orange 50 (2)	Orange 50 (1)	
LCA4/0 LCA _N 4/0 LCD4/0 LCD _N 4/0 SCS4/0	4/0 AWG	1-3/16 1	—	CD-720-3 Purple P54 (2)	CD-920-4/0 Purple P54 (2)	STD (1)	CD-2001-4/0 Purple P54 (2)	—	Purple 54 (2)	Purple 54 (1)	

**CD-920 dies can be used with CT-940CH and CT-2940 tools with CD-940-DA adapter.

① Maximum size with CT-2950 is 500 kcmil lugs, 250 kcmil splices.

② CD-940 dies to be used exclusively with CT-940CH and CT-2940 tools.

③ Half width dies.

④ The CT-1700 crimp pockets are integrated into the crimp head.

⑤ Maximum size: 250 kcmil lugs and splices.

⑥ Minimum size: 4 AWG lugs and splices.

For use with
Copper
Conductors

Installation Tooling and Die Selections for: Types LCA, LCA, LCD, LCDN and SCS (continued)

Thomas & Betts			Burdny					Anderson	Penn-Union	Greenlee
TBM15, TBM15I, TBM15BSCR	TBM8-750M-1, TBM8-750, TBM8-750BSCR, TBM750BSCR®	TBM14M, TBM14BSCR, BPLT14BSCR, 13100A	Y2MR, Y1MR, Y1MRTC	MY29	BAT35, Y39BH, Y35BH, Y750, Y750BH, Y750-2, Y750HS, Y750BH-2, Y39, PAT750, Y35, BAT750	Y45, Y46	Y644M, Y644HS, PAT644, BAT644, Y644MBH	VC6	TDY-1	1989
Die Part Number / Color Code & Die Index Number / (Number of Crimps)										
Red 21 (1)	STD (1)	Red 21 (1)	Red 49 (1)	#8 (1)	U8CRT Red 49 (1)	U8CRT Red 49 (1)	—	—	—	—
Blue 24 (1)	STD (1)	Blue 24 (1)	Blue 7 (2)	#6 (1)	U5CRT Blue 7 (1)	U5CRT Blue 7 (1)	STD (1)	STD (1)	—	—
Gray 29 (1)	STD (1)	Gray 29 (1)	Gray 8 (2)	#4 (1)	U4CRT Gray 8 (1)	U4CRT Gray 8 (1)	STD (1)	STD (1)	—	STD (1)
Brown 33 (1)	STD (1)	Brown 33 (1)	Brown 10 (2)	#2 (1)	U2CRT Brown 9 [solid] / Brown 10 [stranded] (1)	U2CRT Brown 9 [solid] / Brown 10 [stranded] (1)	STD (1)	STD (1)	STD (1)	STD (1)
Green 37 (1)	STD (1)	Green 37 (1)	—	#1 (1)	U1CRT Green 11 (1)	U1CRT Green 11 (1)	STD (1)	STD (1)	STD (1)	STD (1)
Pink 42H® (2)	STD (1)	Pink 42H® (2)	—	1/0 (1)	U25RT Pink 12 (1)	U25RT Pink 12 (1)	STD (1)	STD (1)	STD (1)	STD (1)
Black 45 (1)	STD (1)	Black 45 (1)	—	2/0 (1)	U26RT Black 13 (1)	U26RT Black 13 (1)	STD (1)	STD (1)	STD (1)	STD (1)
Orange 50 (1)	STD (1)	Orange 50 (1)	—	3/0 (1)	U27RT Orange 14 (1)	U27RT Orange 14 (1)	STD (1)	STD (1)	STD (1)	STD (1)
Purple 54H® (2)	STD (1)	Purple 54H® (2)	—	4/0 (1)	U28RT Purple 15 (1)	U28RT Purple 15 (1)	STD (1)	STD (1)	STD (1)	STD (1)

Chart continues on [Pages L10, L11](#) (250 kcmil to 1000 kcmil sizes)

System Overview

For use with Copper Conductors

Installation Tooling and Die Selections for: Types LCA, LCA, LCD, LCDN and SCS (continued)

Terminals

Chart continues from Pages L8,L9

			PANDUIT® (See Crimping Tools Tab — Section G)					Thomas & Betts			
PANDUIT® Part Number	Std. Wire Size	Wire Strip Length (In.)	CT-1700 [®]	CT-720	CT-920, CT-920CH, CT-930, CT-930CH, CT-930LPCH [®] , CT-2920, CT-2930, CT-2931, CT-940CH**	CT-980, CT-2980, CT-980LPCH [®] , CT-980CH, CT-2950 [®] , CT-2981	CT-2001, CT-2002	TBM20S, TBM25S	TBM5	TBM8	TBM12, 13642M
			Die Part Number / Color Code & Die Index Number / (Number of Crimps)								
LCA250 LCAN250 LCD250 LCDN250 SCS250	250 kcmil	1-1/4	—	CD-720-3 Yellow P62 (2)	CD-920-250 Yellow P62 (2)	STD (2)	CD-2001-250 Yellow P62 (2)	—	Yellow 62 (2)	Yellow 62 (2)	Yellow 62 (1)
		1-1/16									
LCA300 LCAN300 LCD300 LCDN300 SCS300	300 kcmil	1-1/4	—	CD-720-4 White P66 (2)	CD-920-300 White P66 (2)	STD (2)	CD-2001-300 White P66 (2)	—	—	White 66 (2)	White 66H [®] (1)
		1-1/16									
LCA350 LCAN350 LCD350 LCDN350 SCS350	350 kcmil	1-1/4	—	CD-720-5 Red P71 (2)	CD-920-350 Red P71 (2)	STD (2)	CD-2001-350 Red P71 (2)	—	—	Red 71 (2)	Red 71H [®] (2)
		1-1/8									
LCA400 LCAN400 LCD400 LCDN400 SCS400	400 kcmil	1-7/16	—	CD-720-6 Blue P76 (2)	CD-920-400 Blue P76 (2)	STD (2)	CD-2001-400 Blue P76 (3)	—	—	Blue 76 (2)	Blue 76H [®] (2)
		1-3/16									
LCA500 LCAN500 LCD500 LCDN500 SCS500	500 kcmil	1-11/16	—	CD-720-7 Brown P87 (2)	CD-920-500 Brown P87 (2)	STD (2)	CD-2001-500 Brown P87 (3)	—	—	Brown 87 (2)	Brown 87H [®] (2)
		1-3/8									
LCA600 LCAN600 LCD600 LCDN600 SCS600	600 kcmil	1-9/16	—	—	CD-920-600 Green P94 (2)	STD (2)	—	—	—	—	Green 94H [®] (2)
		1-3/8									
LCA750 LCAN750 LCD750 LCDN750 SCS750	750 kcmil	1-5/8	—	—	CD-920-750 CD-940-750 [®] Black P106 (2)	STD (2)	—	—	—	—	Black 106H [®] (2)
		1-7/8									
SCS1000	1000 kcmil	1-7/8	—	—	CD-940-1000 [®] White P125 (4)	—	—	—	—	—	—

**CD-920 dies can be used with CT-940CH and CT-2940 tools with CD-940-DA adapter.

- ① Maximum size with CT-2950 is 500 kcmil lugs, 250 kcmil splices.
- ② CD-940 dies to be used exclusively with CT-940CH and CT-2940 tools.
- ③ Half width dies.
- ④ The CT1700 crimp pockets are integrated into the crimp head.
- ⑤ Maximum size: 250 kcmil lugs and splices.
- ⑥ Minimum size: 4 AWG lugs and splices.

Technical Info

Index

For use with
Copper
Conductors

Installation Tooling and Die Selections for: Types LCA, LCA, LCD, LCDN and SCS (continued)

Thomas & Betts			Burndy					Anderson	Penn-Union	Greenlee
TBM15, TBM15I, TBM15BSCR	TBM8-750M-1, TBM8-750, TBM8-750BSCR, TBM750BSCR®	TBM14M, TBM14BSCR, BPLT14BSCR, 13642M, 13100A	Y2MR, Y1MR, Y1MRTC	MY29	BAT35, Y35BH, Y750, Y39BH, Y750BH, Y750-2, Y750HS, Y750BH-2, Y39, PAT750, Y35, BAT750	Y45, Y46	Y644M, Y644HS, PAT644, BAT644, Y644MBH	VC6	TDY-1	1989
Die Part Number / Color Code & Die Index Number / (Number of Crimps)										
Yellow 62 (1)	STD (1)	Yellow 62 (1)	—	250 (1)	U29RT Yellow 16 (1)	U29RT Yellow 16 (1)	STD (1)	STD (2)	STD (1)	STD (1)
White 66 (1)	STD (1)	White 66 (1)	—	—	U30RT White 17 (2)	U30RT White 17 (2)	STD (1)	STD (2)	STD (1)	STD (1)
Red 71H® (2)	STD (1)	Red 71H® (2)	—	—	U31RT Red 18 (2)	U31RT Red 18 (2)	STD (1)	STD (2)	STD (1)	STD (1)
Blue 76H® (2)	STD (1)	Blue 76 (1)	—	—	U32RT Blue 19 (2)	U32RT Blue 19 (2)	STD (1)	STD (2)	STD (1)	STD (1)
Brown 87H® (2)	STD (1)	Brown 87H® (2)	—	—	U34RT Brown 20 (2)	U34RT Brown 20 (2)	STD (1)	STD (2)	STD (1)	STD (1)
Green 94H® (2)	STD (1)	Green 94H® (2)	—	—	U36RT Green 22 (2)	U36RT Green 22 (2)	STD (1)	—	STD (1)	—
Black 106H® (2)	STD (1)	Black 106H® (2)	—	—	U39RT Black 24 (3)	U39RT Black 24 (3)	STD (1)	—	STD (1)	—
125H® (2)	—	125H® (2)	—	—	—	S44RT White 27 (4)	—	—	—	—

**CD-920 dies can be used with CT-940CH and CT-2940 tools with CD-940-DA adapter.

- ① Maximum size with CT-2950 is 500 kcmil lugs, 250 kcmil splices.
- ② CD-940 dies to be used exclusively with CT-940CH and CT-2940 tools.
- ③ Half width dies.
- ④ The CT1700 crimp pockets are integrated into the crimp head.
- ⑤ Maximum size: 250 kcmil lugs and splices.
- ⑥ Minimum size: 4 AWG lugs and splices.

System
Overview

Terminals

Disconnects

Splices

Ferrules

Compression
Connectors

Crimping
Tools

Mechanical
Connectors

Grounding
Connectors

Support
Products

Technical
Info

Index

System Overview

For use with Copper Conductors

Installation Tooling and Die Selections for: Types LCB, LCBN, LCC, LCCN & SCL

Terminals

Disconnects

Splices

Ferrules

Compression Connectors

Crimping Tools

Mechanical Connectors

Grounding Connectors

Support Products

Technical Info

Index

PANDUIT® Part Number	Std. Wire Size	Wire Strip Length (In.)	PANDUIT® (See Crimping Tools Tab — Section G)					Thomas & Betts				
			CT-1700®	CT-720	CT-920, CT-920CH, CT-930, CT-930CH, CT-2920, CT-2930, CT-2931, CT-930LPCH®, CT-940CH**, CT-2940**	CT-980, CT-980CH, CT-2950®, CT-2980, CT-2981, CT-980LPCH®	CT-2001, CT-2002	TBM20S, TBM25S	TBM5	TBM8	TBM12, 13642M	
L = Lug S = Splice			Die Part Number / Color Code & Die Index Number / (Number Of Crimps)									
LCB8 LCBN8 LCC8 LCCN8 SCL8	8 AWG	11/16 1-1.16	Red P21 (3)	CD-720-1 Red P21 (2)	CD-920-8 Red P21 (1)	—	CD-2001-8 Red P21 (2)	Red 21 (3)	Red 21 (1)	Red 21 (1)	Red 21 (1)	
LCB6 LCBN6 LCC6 LCCN6 SCL6	6 AWG	1-1.16 1-1/8	Blue P24 (3)	CD-720-1 Blue P24 (2)	CD-920-6 Blue P24 (1)	—	CD-2001-6 Blue P24 (2)	Blue 24 (3)	Blue 24 (1)	Blue 24 (1)	Blue 24 (1)	
LCB4 LCBN4 LCC4 LCCN4 SCL4	2 AWG SOL. 4-3 AWG STR	1-1.16 1-1/8	Gray P29 (3)	CD-720-1 Gray P29 (2)	CD-920-4 Gray P29 (1)	STD (1)	CD-2001-4 Gray P29 (2)	Gray 29 (3)	Gray 29 (1)	Gray 29 (1)	Gray 29 (1)	
LCB2 LCBN2 LCC2 LCCN2 SCL2	2 AWG	1-3/16 1-1/4	Brown P33 (3)	CD-720-1 Brown P33 (2)	CD-920-2 Brown P33 (1)	STD (1)	CD-2001-2 Brown P33 (2)	Brown 33 (3)	Brown 33 (1)	Brown 33 (1)	Brown 33 (1)	
LCB1 LCBN1 LCC1 LCCN1 SCL1	1 AWG	1-3/8	Green P37 (4)	CD-720-2 Green P37 (2)	CD-920-1 Green P37 (1)	STD (1)	CD-2001-1 Green P37 (2)	—	Green 37 (1)	Green 37 (1)	Green 37 (1)	
LCB1/0 LCBN1/0 LCC1/0 LCCN1/0 SCL1/0	1/0 AWG	1-7/16 1-3/8	—	CD-720-2 Pink P42 (2)	CD-920-1/0 Pink P42 (2)	STD (2)	CD-2001-1/0 Pink P42 (2)	—	Pink 42 (2)	Pink 42 (2)	Pink 42 (2)	
LCB2/0 LCBN2/0 LCC2/0 LCCN2/0 SCL2/0	2/0 AWG	1-1/2	—	CD-720-2 Black P45 (3)	CD-920-2/0 Black P45 (3)	STD (2)	CD-2001-2/0 Black P45 (3)	—	Black 45 (3)	Black 45 (3)	Black 45 (2)	
LCB3/0 LCBN3/0 LCC3/0 LCCN3/0 SCL3/0	3/0 AWG	1-1/2	—	CD-720-2 Orange P50 (3)	CD-920-3/0 Orange P50 (3)	STD (2)	CD-2001-3/0 Orange P50 (3)	—	Orange 50 (3)	Orange 50 (3)	Orange 50 (2)	
LCB4/0 LCBN4/0 LCC4/0 LCCN4/0 SCL4/0	4/0 AWG	1-9/16 1-5/8	—	CD-720-3 Purple P54 (3)	CD-920-4/0 Purple P54 (3)	STD (2)	CD-2001-4/0 Purple P54 (3)	—	Purple 54 (3)	Purple 54 (3)	Purple 54 (2)	
LCB250 LCBN250 LCC250 LCCN250 SCL250	250 kcmil	1-5/8	—	CD-720-3 Yellow P62 (4)	CD-920-250 Yellow P62 (3)	STD (3)	CD-2001-250 Yellow P62 (3)	—	Yellow 62 (4)	Yellow 62 (4)	Yellow 62 (2)	
LCB300 LCBN300 LCC300 LCCN300 SCL300	300 kcmil	2	—	CD-720-4 White P66 (4)	CD-920-300 White P66 (3)	STD (3)	CD-2001-300 White P66 (3)	—	—	White 66 (4)	White 66H* (4)	

*Half width dies.

**CD-920 Dies can be used with CT-940CH and CT-2940 tools with CD-940-DA adapter.

① Require U Die adapter.

② CD-940 Dies to be used exclusively with C-940CH tool.

③ Maximum size: 500 kcmil lugs and 250 kcmil splices.

④ The CT-1700 crimp die pockets are integrated into the tool head.

⑤ Maximum size: 250 kcmil lugs and splices.

⑥ Minimum size: 4 AWG lugs and splices.

For use with
Copper
Conductors

Installation Tooling and Die Selections for: Types LCB, LCBN, LCC, LCCN & SCL (continued)

Thomas & Betts			Burdny					Anderson	Penn-Union	Greenlee
TBM15 TBM15I TBM15BSCR	TBM8-750M-1 TBM8-750 TBM750BSCR® TBM8-750BSCR	TBM14M TBM14BSCR BPLT14BSCR 13100A	Y2MR Y1MR Y1MRTC	MY29	Y35, Y39, Y39BH, Y750, Y750-2, Y750BH, Y750HS, Y750BH-2, PAT750, BAT750, BAT35	Y45®, Y46®	Y644M, Y644HS, Y644MBH, PAT644, BAT644	VC6	TDY-1	1989
Die Part Number / Color Code & Die Index Number / (Number of Crimps)										
Red 21 (1)	STD (1)	Red 21 (1)	Red 49 (2)	#8 (1)	U8CRT Red 49 (1)	U8CRT Red 49 (1)	—	—	—	—
Blue 24 (1)	STD (1)	Blue 24 (1)	Blue 7 (2)	#6 (1)	U5CRT Blue 7 (1)	U5CRT Blue 7 (1)	STD (1)	STD (1)	—	—
Gray 29 (1)	STD (1)	Gray 29 (1)	Gray 8 (2)	#4 (1)	U4CRT Gray 8 (1)	U4CRT Gray 8 (1)	STD (1)	STD (1)	—	STD (1)
Brown 33 (1)	STD (1)	Brown 33 (1)	Brown 10 (2)	#2 (1)	U2CRT Brown 9 (solid) / Brown 10 (stranded) (2)	U2CRT Brown 9 (solid) / Brown 10 (stranded) (2)	STD (1)	STD (1)	STD (1)	STD (1)
Green 37 (1)	STD (1)	Green 37 (1)	—	#1 (1)	U1CRT Green 11 (2)	U1CRT Green 11 (2)	STD (1)	STD (1)	STD (1)	STD (1)
Pink 42H* (4)	STD (2)	Pink 42H* (4)	—	1/0 (2)	U25RT Pink 12 (2)	U25RT Pink 12 (2)	STD (1)	STD (1)	STD (1)	STD (1)
Black 45 (2)	STD (2)	Black 45 (2)	—	2/0 (2)	U26RT Black 13 (2)	U26RT Black 13 (2)	STD (1)	STD (1)	STD (1)	STD (1)
Orange 50 (2)	STD (2)	Orange 50 (2)	—	3/0 (2)	U27RT Orange 14 (2)	U27RT Orange 14 (2)	STD (1)	STD (2)	STD (1)	STD (1)
Purple 54H* (4)	STD (2)	Purple 54H* (4)	—	4/0 (2)	U28RT Purple 15 (2)	U28RT Purple 15 (2)	STD (1)	STD (2)	STD (1)	STD (1)
Yellow 62 (2)	STD (2)	Yellow 62 (2)	—	250 (2)	U29RT Yellow 16 (2)	U29RT Yellow 16 (2)	STD (1)	STD (2)	STD (1)	STD (1)
White 66 (3)	STD (3)	White 66 (3)	—	—	U30 RT White 17 (3)	U30 RT White 17 (3)	STD (1)	STD (3)	STD (2)	STD (1)

* Half width dies.

**CD-920 Dies can be used with CT-940CH and CT-2940 tools with CD-940-DA adapter.

① Require U Die adapter.

② CD-940 Dies to be used exclusively with C-940CH tool.

③ Maximum size: 500 kcmil lugs and 250 kcmil splices.

④ The CT-1700 crimp die pockets are integrated into the tool head.

⑤ Maximum size: 250 kcmil lugs and splices.

⑥ Minimum size: 4 AWG lugs and splices.

Chart continues on [Pages L14, L15](#) (350 kcmil to 1000 kcmil sizes)

System Overview

For use with Copper Conductors

Installation Tooling and Die Selections for: Types LCB, LCBN, LCC, LCCN & SCL (continued)

Terminals

Chart continues from sizes 8 AWG thru 300 kcmil on [Pages L12,L13](#)

Disconnects

PANDUIT® Part Number	Std. Wire Size	Wire Strip Length (In.)
L = Lug S = Splice		

			PANDUIT® (See Crimping Tools Tab — Section G)					Thomas & Betts				
			CT-1700®	CT-720	CT-920, CT-920CH, CT-930, CT-930CH, CT-2920, CT-2930, CT-2931, CT-930LPCH®, CT-940CH**, CT-2940**	CT-980, CT-980CH, CT-2950®, CT-2980, CT-2981, CT-980LPCH®	CT-2001, CT-2002	TBM20S, TBM25S	TBM5	TBM8	TBM12, 13642M	
			Die Part Number / Color Code & Die Index Number / (Number Of Crimps)									
Splices	LCB350 LCBN350 LCC350 LCCN350 SCL350	350 kcmil	2	—	CD-720-5 Red P71 (4)	CD-920-350 Red P71 (3)	STD (3)	CD-2001-350 Red P71 (3)	—	—	Red 71 (4)	Red 71H* (4)
	LCB400 LCBN400 LCC400 LCCN400 SCL400	400 kcmil	2	—	CD-720-6 Blue P76 (4)	CD-920-400 Blue P76 (3)	STD (3)	CD-2001-400 Blue P76 (4)	—	—	Blue 76 (4)	Blue 76H* (4)
			2-1/8									
	LCB500 LCBN500 LCC500 LCCN500 SCL500	500 kcmil	2-1/4	—	CD-720-7 Brown P87 (4)	CD-920-500 Brown P87 (3)	STD (3)	CD-2001-500 Brown P87 (4)	—	—	Brown 87 (4)	Brown 87H* (4)
Compression Connectors	LCB600 LCBN600 LCC600 LCCN600 SCL600	600 kcmil	2-11/16	—	—	CD-920-600 Green P94 (4)	STD (3)	—	—	—	—	Green 94H* (4)
	LCB750 LCBN750 LCC750 LCCN750 SCL750	750 kcmil	2-15/16	—	—	CD-920-750 CD-940-750 ^② Black P106 (4)	STD (3)	—	—	—	—	Black 106H* (4)
			2-7/8									
	LCB800 LCBN800 LCC800 LCCN800 SCL800	800 kcmil	2-7/8	—	—	CD-940-800 ^② Orange P107 (4)	—	—	—	—	—	—
Mechanical Connectors	LCB1000 LCBN1000 LCC1000 LCCN1000 SCL1000	1000 kcmil	3-3/16	—	—	CD-940-1000 ^② White P125 (4)	—	—	—	—	—	Yellow 125H* (4)
			3									

*Half width dies.

**CD-920 Dies can be used with CT-940CH and CT-2940 tools with CD-940-DA adapter.

- ① Require U Die adapter.
- ② CD-940 Dies to be used exclusively with CT-940CH tool.
- ③ Maximum size: 500 kcmil lugs and 250 kcmil splices.
- ④ The CT-1700 crimp die pockets are integrated into the tool head.
- ⑤ Maximum size: 250 kcmil lugs and splices.
- ⑥ Minimum size: 4 AWG lugs and splices.

Grounding Connectors

Support Products

Technical Info

Index

For use with
Copper
Conductors

Installation Tooling and Die Selections for: Types LCB, LCBN, LCC, LCCN & SCL (continued)

Thomas & Betts			Burdny					Anderson	Penn-Union	Greenlee
TBM15 TBM15I TBM15BSCR	TBM8-750M-1 TBM8-750 TBM750BSCR± TBM8-750BSCR	TBM14M TBM14BSCR BPLT14BSCR 13100A	Y2MR Y1MR Y1MRTC	MY29	Y35, Y35BH, Y39, Y39BH, Y750, Y750-2, Y750BH, Y750HS, Y750BH-2, PAT750, BAT750, BAT35	Y45 ^③ , Y46 ^③	Y644M, Y644MBH, PAT644, Y644HS, BAT644	VC6	TDY-1	1989
Die Part Number / Color Code & Die Index Number / (Number Of Crimps)										
Red 71H* (4)	STD (3)	Red 71 (4)	—	—	U31RT (Red 18 (3)	U31RT Red 18 (3)	STD (1)	STD (3)	STD (2)	STD (1)
Blue 76H* (4)	STD (3)	Blue 76 (4)	—	—	U32RT Blue 19 (3)	U32RT Blue 19 (3)	STD (1)	STD (3)	STD (2)	STD (1)
Brown 87H* (4)	STD (3)	Brown 87 (4)	—	—	U34RT Brown 20 (3)	U34RT Brown 20 (3)	STD (1)	STD (3)	STD (2)	STD (1)
Green 94H* (4)	STD (4)	Green 94 (4)	—	—	U36RT Green 22 (4)	U36RT Green 22 (4)	STD (1)	—	STD (4)	—
Black 106H* (4)	STD (4)	Black 106 (4)	—	—	U39RT Black 24 (5)	U39RT Black 24 (5)	STD (1)	—	STD (2)	—
—	—	—	—	—	—	—	—	—	—	—
125H* (4)	—	125H* (4)	—	—	—	S44RT White 27 (6)	—	—	—	—

*Half width dies.

**CD-920 Dies can be used with CT-940CH and CT-2940 tools with CD-940-DA adapter.

① Require U Die adapter.

② CD-940 Dies to be used exclusively with CT-940CH tool.

③ Maximum size: 500 kcmil lugs and 250 kcmil splices.

④ The CT-1700 crimp die pockets are integrated into the tool head.

⑤ Maximum size: 250 kcmil lugs and splices.

⑥ Minimum size: 4 AWG lugs and splices.

System
Overview

Terminals

Disconnects

Splices

Ferrules

Compression
Connectors

Crimping
Tools

Mechanical
Connectors

Grounding
Connectors

Support
Products

Technical
Info

Index

System Overview

For use with Copper Conductors

Installation Tooling and Die Selections for: Types LCBH, LCCH and SCH

Terminals

Disconnects

Splices

Ferrules

Compression Connectors

Crimping Tools

Mechanical Connectors

Grounding Connectors

Support Products

Technical Info

Index

			PANDUIT® (See Crimping Tools Tab — Section G)					Thomas & Betts		
PANDUIT® Part Number	Std. Wire Size	Wire Strip Length (In.)	CT-1700®	CT-720	CT-920, CT-920CH, CT-2920, CT930, CT-930CH®, CT-2930, CT2931, CT-930LPCH®, CT-940CH**, CT-2940**	CT-980, CT-980CH, CT-2950‡, CT-2981, CT980LPCH®	CT-2001, CT-2002	TBM5	TBM8	TBM12 13642M
			Die Part Number / Color Code & Die Index Number / (Number Of Crimps)							
LCBH6 LCCH6 SCH6	6 AWG	1-1/8 15/16	Blue P24 (3)	CD-720-1 Blue P24 (2)	CD-920-6 Blue P24 (1)	—	CD-2001-6 Blue P24 (2)	Blue 24 (1)	Blue 24 (1)	Blue 24 (1)
LCBH4 LCCH4 SCH4	4 AWG	1-1/8 15/16	Gray P29 (3)	CD-720-1 Gray P29 (2)	CD-920-4 Gray P29 (1)	STD (1)	CD-2001-4 Gray P29 (2)	Gray 29 (1)	Gray 29 (1)	Gray 29 (1)
LCBH2 LCCH2 SCH2	2 AWG	1-1/4 1-1/16	Brown P33 (3)	CD-720-1 Brown P33 (2)	CD-920-2 Brown P33 (1)	STD (1)	CD-2001-2 Brown P33 (2)	Brown 33 (1)	Brown 33 (1)	Brown 33 (1)
LCBH1 LCCH1 SCH1	1 AWG	1-7/16 1-1/16	Green P37 (3)	CD-720-2 Green P37 (2)	CD-920-1 Green P37 (1)	STD (1)	CD-2001-1 Green P37 (2)	Green 37 (1)	Green 37 (1)	Green 37 (1)
LCBH1/0 LCCH1/0 SCH1/0	1/0 AWG	1-1/2 1-1/16	—	CD-720-2 Pink P42 (2)	CD-920-1/0 Pink P42 (2)	STD (2)	CD-2001-1/0 Pink P42 (2)	Pink 42 (2)	Pink 42 (2)	Pink 42 (2)
LCBH2/0 LCCH2/0 SCH2/0	2/0 AWG	1-9/16 1-1/8	—	CD-720-2 Black P45 (3)	CD-920-2/0 Black P45 (3)	STD (2)	CD-2001-2/0 Black P45 (3)	Black 45 (3)	Black 45 (3)	Black 45 (2)
LCBH3/0 LCCH3/0 SCH3/0	3/0 AWG	1-9/16 1-1/4	—	CD-720-2 Orange P50 (3)	CD-920-3/0 Orange P50 (3)	STD (2)	CD-2001-3/0 Orange P50 (3)	Orange 50 (3)	Orange 50 (3)	Orange 50 (2)
LCBH4/0 LCCH4/0 SCH4/0	4/0 AWG	1-5/8 1-1/4	—	CD-720-3 Purple P54 (3)	CD-920-4/0 Purple P54 (3)	STD (2)	CD-2001-4/0 Purple P54 (3)	Purple 54 (3)	Purple 54 (3)	Purple 54 (3)
LCBH250 LCCH250 SCH250	250 kcmil	1-11/16 1-5/16	—	CD-720-3 Yellow P62 (4)	CD-920-250 Yellow P62 (3)	STD (3)	CD-2001-250 Yellow P62 (3)	Yellow 62 (4)	Yellow 62 (4)	Yellow 62 (2)
LCBH300 LCCH300 SCH300	300 kcmil	2-5/16 1-3/8	—	CD-720-4 White P66 (4)	CD-920-300 White P66 (3)	STD (3)	CD-2001-300 White P66 (3)	—	White 66 (4)	White 66H* (4)
LCBH350 LCCH350 SCH350	350 kcmil	2-5/16 1-7/16	—	CD-720-5 Red P71 (4)	CD-920-350 Red P71 (3)	STD (3)	CD-2001-350 Red P71 (3)	—	Red 71 (4)	Red 71H* (4)
LCBH400 LCCH400 SCH400	400 kcmil	2-3/8 1-9/16	—	CD-720-6 Blue P76 (4)	CD-920-400 Blue P76 (3)	STD (3)	CD-2001-400 Blue P76 (4)	—	Blue 76 (4)	Blue 76H* (4)
LCBH500 LCCH500 SCH500	500 kcmil	2-9/16 1-13/16	—	CD-720-7 Brown P87 (4)	CD-920-500 Brown P87 (3)	STD (3)	CD-2001-500 Brown P87 (4)	—	Brown 87 (4)	Brown 87H* (4)
LCBH600 LCCH600 SCH600	600 kcmil	2-3/4 1-15/16	—	—	CD-920-600 Green P94 (4)	STD (3)	—	—	—	Green 94H* (4)
LCBH750 LCCH750 SCH750	750 kcmil	2-15/16 2-3/16	—	—	CD-920-750, CD-940-750▲ Black P106 (4)	STD (3)	—	—	—	Black 106H* (4)
LCBH1000 LCCH1000 SCH1000	1000 kcmil	3-1/16 2-9/16	—	—	CD-940-1000▲ Green P125 (4)	—	—	—	—	125H* (4)

*Half width dies.

**CD-920 Dies can be used with CT-940CH Tool with CD-940-DA Die Adapter.

‡Maximum Size: 500 kcmil lug, 250 kcmil splice.

▲CD-940 Dies to be used exclusively with CT-940CH Tool.

① CT-1700 crimp die pockets are integrated into the tool head.

② Maximum size: 250 kcmil lugs and splices.

③ Minimum size: 4 AWG lugs and splices.

For use with
Copper
Conductors

Installation Tooling and Die Selections for: Types LCBH, LCCH and SCH (continued)

Thomas & Betts			Burdny			Anderson	Penn-Union	Greenlee	
TBM15, TBM15I, TBM15BSCR	TBM8-750M-1, TBM8-750, TBM8-750BSCR, TBM750BSCR®	TBM14M, TBM14BSCR, BPLT14BSCR, 13100A	MY29	Y39, Y35, Y35BH, BAT35, Y750, Y750BH-2, Y750HS, Y750-2, BAT750, PAT750, Y39BH, Y750BH	Y45, Y46	Y644, Y644HS, PAT644, BAT644, Y644MBH	VC6	TDY-1	1989
Die Part Number / Color Code & Die Index Number / (Number Of Crimps)									
Blue 24 (1)	STD (1)	Blue 24 (1)	6 (1)	U5CRT Blue 7 (1)	U5CRT Blue 7 (1)	STD (1)	STD (1)	—	—
Gray 29 (1)	STD (1)	Gray 29 (1)	4 (1)	U4CRT Gray 8 (1)	U4CRT Gray 8 (1)	STD (1)	STD (1)	—	STD (1)
Brown 33 (1)	STD (1)	Brown 33 (1)	2 (1)	U2CRT Brown 10 (2)	U2CRT Brown 10 (2)	STD (1)	STD (1)	STD (1)	STD (1)
Green 37 (1)	STD (1)	Green 37 (1)	1 (1)	U1CRT Green 11 (2)	U1CRT Green 11 (2)	STD (1)	STD (1)	STD (1)	STD (1)
Pink 42H* (4)	STD (2)	Pink 42H* (4)	1/0 (2)	U25RT Pink 12 (2)	U25RT Pink 12 (2)	STD (1)	STD (1)	STD (1)	STD (1)
Black 45 (2)	STD (2)	Black 45 (2)	2/0 (2)	U26RT Black 13 (2)	U26RT Black 13 (2)	STD (1)	STD (1)	STD (1)	STD (1)
Orange 50 (2)	STD (2)	Orange 50 (2)	3/0 (2)	U27RT Orange 14 (2)	U27RT Orange 14 (2)	STD (1)	STD (2)	STD (1)	STD (1)
Purple 54H* (4)	STD (2)	Purple 54H* (4)	4/0 (2)	U28RT Purple 15 (2)	U28RT Purple 15 (2)	STD (1)	STD (2)	STD (1)	STD (1)
Yellow 62 (2)	STD (2)	Yellow 62 (2)	250 (2)	U29RT Yellow 16 (2)	U29RT Yellow 16 (2)	STD (1)	STD (2)	STD (2)	STD (1)
White 66H* (4)	STD (3)	White 66 (4)	—	U30RT White 17 (3)	U30RT White 17 (3)	STD (1)	STD (3)	STD (2)	STD (1)
Red 71H* (4)	STD (3)	Red 71H* (4)	—	U31RT Red 18 (3)	U31RT Red 18 (3)	STD (1)	STD (3)	STD (2)	STD (1)
Blue 76H* (4)	STD (3)	Blue 76 (4)	—	U32RT Blue 19 (3)	U32RT Blue 19 (3)	STD (1)	STD (3)	STD (2)	STD (1)
Brown 87H* (4)	STD (3)	Brown 87H* (4)	—	U34RT Brown 20 (3)	U34RT Brown 20 (3)	STD (1)	STD (3)	STD (2)	STD (1)
Green 94H* (4)	STD (4)	Green 94H* (4)	—	U36RT Green 22 (4)	U36RT Green 22 (4)	STD (1)	—	STD (2)	—
Black 106H* (4)	STD (4)	Black 106H* (4)	—	U39RT Black24 (5)	U39RT Black24 (5)	STD (1)	—	STD (2)	—
125H* (4)	—	125H* (4)	—	—	S44RT White 27 (6)	—	—	—	—

*Half width dies.

**CD-920 Dies can be used with CT-940CH Tool with CD-940-DA Die Adapter.

‡Maximum Size: 500 kcmil lug, 250 kcmil splice.

▲CD-940 Dies to be used exclusively with CT-940CH Tool.

① CT-1700 crimp die pockets are integrated into the tool head.

② Maximum size: 250 kcmil lugs and splices.

③ Minimum size: 4 AWG lugs and splices.

System Overview

Terminals

Disconnects

Splices

Ferrules

Compression Connectors

Crimping Tools

Mechanical Connectors

Grounding Connectors

Support Products

Technical Info

Index

System Overview

For use with
Copper
Conductors

Installation Tooling and Die Selections for: Type SCT

Terminals

Disconnects

Splices

Ferrules

Compression
Connectors

Crimping
Tools

Mechanical
Connectors

Grounding
Connectors

Support
Products

Technical
Info

Index

			PANDUIT® (See Crimping Tools Tab — Section G)					Thomas & Betts	
PANDUIT® Part Number	Std. Wire Size	Wire Strip Length (In.)	CT-1700 ^①	CT-720	CT-920, CT-920CH, CT-2920, CT930, CT-930CH, CT-2930, CT2931, CT-940CH**, CT-2940**	CT-980, CT-980CH, CT-2950‡, CT-2980, CT-2981	CT-2001, CT-2002	TBM5	TBM8
	Main Tap	Main Tap							
SCT2-2	2 AWG	2	Brown P33 (3)	CD-720-1 Brown P33 (2)	CD-920-2 Brown P33 (1)	STD (1)	CD-2001-2 Brown P33 (2)	Brown (1)	Brown (1)
	2 AWG	1-9/16							
SCT1/0-1/0	1/0 AWG	2-1/16	Pink P42 (3)	CD-720-2 Pink P42 (2)	CD-920-1/0 Pink P42 (2)	STD (1)	CD-2001-1/0 Pink P42 (2)	Pink (2)	Pink (2)
	1/0 AWG	1-9/16							
SCT2/0-2/0	2/0 AWG	2-1/16	—	CD-720-2 Black P45 (3)	CD-920-2/0 Black P45 (3)	STD (1)	CD-2001-2/0 Black P45 (3)	Black (3)	Black (3)
	2/0 AWG	1-9/16							
SCT4/0-1/0	4/0 AWG	2-1/16	—	CD-720-2 Orange P50 (3)	CD-920-3/0 Orange P50 (3)	STD (1)	CD-2001-3/0 Orange P50 (3)	Orange (3)	Orange (3)
	1/0 AWG	1-9/16							
SCT4/0-4/0	4/0 AWG	2-1/8	—	CD-720-3 Purple P54 (3)	CD-920-4/0 Purple P54 (3)	STD (1)	CD-2001-4/0 Purple P54 (3)	Purple (3)	Purple (3)
	4/0 AWG	1-11/16							
SCT250-250	250 kcmil	2-3/16	—	CD-720-3 Yellow P62 (4)	CD-920-250 Yellow P62 (3)	STD (1)	CD-2001-250 Yellow P62 (3)	Yellow (4)	Yellow (4)
	250 kcmil	1-11/16							
SCT300-300	300 kcmil	2-13/16	—	CD-720-4 White P65 (4)	CD-920-300 White P65 (3)	STD (1)	CD-2001-300 White P66 (3)	—	White (4)
	300 kcmil	2-1/16							
SCT350-350	350 kcmil	2-13/16	—	CD-720-5 Red P71 (4)	CD-920-350 Red P71 (3)	STD (1)	CD-2001-350 Red P71 (3)	—	Red (4)
	350 kcmil	2-1/16							
SCT500-4/0	500 kcmil	2-15/16	—	CD-720-7 Brown P87 (4)	CD-920-500 Brown P87 (3)	STD (1)	CD-2001-500 Brown P87 (4)	—	Brown (4)
	4/0 AWG	2-15/16							
SCT500-500	500 kcmil	3-1/8	—	CD-720-7 Brown P87 (4)	CD-920-500 Brown P87 (3)	STD (1)	CD-2001-500 Brown P87 (4)	—	Brown (4)
	500 kcmil	2-9/16							

*Half width dies.

**CD-920 Dies can be used with CT-940CH Tool with CD-940-DA Die Adapter.

‡Maximum Size: 250 kcmil.

① The CT-1700 crimp die pockets are integrated into the tool head.

For use with
Copper
Conductors

Installation Tooling and Die Selections for: Type SCT (continued)

Thomas & Betts				Burndy			Anderson	Penn-Union	Greenlee
TBM12, 13642M	TBM15, TBM15I, TBM15BSCR	TBM8-750M-1, TBM8-750, TBM8-750BSCR	TBM14M, TBM14BSCR, BPLT14BSCR, 13100A	MY29	Y39, Y35, Y35BH, Y750HS, Y750, BAT35, Y45, Y39BH, Y46, Y750-2, BAT750, PAT750, Y750BH-2, Y750BH	Y644, Y644HS, PAT644, BAT644, Y644MBH	VC6	TDY-1	1989
Die Part Number / Color Code & Die Index Number / (Number of Crimps)									
Brown 33 (1)	Brown 33 (1)	STD (1)	Brown 33 (1)	2 (1)	U2CRT Brown 10 (2)	STD (1)	STD (1)	STD (1)	STD (1)
Pink 42H* (2)	Pink 42H* (4)	STD (2)	Pink 42H* (4)	1/0 (2)	U25RT Pink 12 (2)	STD (1)	STD (1)	STD (1)	STD (1)
Black 45 (2)	Black 45 (2)	STD (2)	Black 45 (2)	2/0 (2)	U26RT Black 13 (2)	STD (1)	STD (1)	STD (1)	STD (1)
Orange 50 (2)	Orange 50 (2)	STD (2)	Orange 50 (2)	3/0 (2)	U27RT Orange 14 (2)	STD (1)	STD (2)	STD (1)	STD (1)
Pink 42 (2)	Pink 42H* (4)		Pink 42H* (4)	1/0 (2)	U25RT Pink 12 (2)				
Purple 54 (2)	Purple 54H* (4)	STD (2)	Purple 54H* (4)	4/0 (2)	U28RT Purple 15 (2)	STD (1)	STD (2)	STD (1)	STD (1)
Yellow 62 (2)	Yellow 62 (2)	STD (2)	Yellow 62 (2)	250 (2)	U29RT Yellow 16 (2)	STD (1)	STD (2)	STD (1)	STD (1)
White 66H* (4)	White 66H* (4)	STD (3)	White 66H* (4)	—	U30RT White 17 (3)	STD (1)	STD (3)	STD (2)	STD (1)
Red 71H* (4)	Red 71H* (4)	STD (3)	Red 71 (3)	—	U31RT Red 18 (3)	STD (1)	STD (3)	STD (2)	STD (1)
Brown 87H* (4)	Brown 87H* (4)	STD (3)	Brown 87 (3)	—	U34RT Brown 20 (3)	STD (1)	STD (3)	STD (2)	STD (1)
Olive 54 (4)	Olive 54H* (4)		Olive 54H* (3)	—	U28RT Purple 15 (3)				
Brown 87H* (4)	Brown 87H* (4)	STD (3)	Brown 87H* (4)	—	U34RT Brown 20 (3)	STD (1)	STD (3)	STD (2)	STD (1)

*Half width dies.

**CD-920 Dies can be used with CT-940CH Tool with CD-940-DA Die Adapter.

‡Maximum Size: 250 kcmil.

① The CT-1700 crimp die pockets are integrated into the tool head

System
Overview

Terminals

Disconnects

Splices

Ferrules

Compression
Connectors

Crimping
Tools

Mechanical
Connectors

Grounding
Connectors

Support
Products

Technical
Info

Index

System Overview

For use with Copper Conductors

Installation Tooling and Die Selections for: Type PS

Terminals

Disconnects

Splices

Ferrules

Compression Connectors

Crimping Tools

Mechanical Connectors

Grounding Connectors

Support Products

Technical Info

Index

PANDUIT® Part Number	Circular Mil Range		PANDUIT® (See Crimping Tools Tab — Section G)				Thomas & Betts	
	Min.	Max.	CT-720	CT-920, CT-930, CT-930CH, CT-2920, CT-2930, CT-2931, CT-940**, CT-940CH**	CT-980, CT980CH, CT2950, CT-2980, CT-2981	CT-2001, CT-2002	TBM5, TBM8	TBM12, 13642M
	Die Part Number / Color Code & Die Index Number / (Number of Crimps)							
PS8	19,000	25,000	CD-720-1 Red P21 (1)	CD-920-8 Red P21 (1)	—	CD-2001-8 Red P21 (1)	Red (1)	Red 21 (1)
PS6	25,000	40,000	CD-720-1 Blue P24 (1)	CD-920-6 Blue P24 (1)	Std (1)	CD-2001-6 Blue P24 (1)	Blue (1)	Blue 24 (1)
PS4	40,000	65,000	CD-720-1 Gray P29 (1)	CD-920-4 Gray P29 (1)	Std (1)	CD-2001-4 Gray P29 (1)	Gray (1)	Gray 29 (1)
PS2	65,000	100,000	CD-720-1 Brown P33 (1)	CD-920-2 Brown P33 (1)	Std (1)	CD-2001-2 Brown P33 (1)	Brown (1)f	Brown 33 (1)
PS1	100,00	130,000	CD-720-2 Green P37 (1)	CD-920-1 Green P37 (1)	Std (1)	CD-2001-1 Green P37 (1)	Green (1)	Green 37 (1)
PS1/0	130,000	160,000	CD-720-2 Pink P42 (2)	CD-920-1/0 Pink P42 (1)	Std (1)	CD-2001-1/0 Pink P42 (2)	Pink (2)	Pink 42 (1)
PS2/0	160,000	200,00	CD-720-2 Black P45 (2)	CD-920-2/0 Black P45 (1)	Std (1)	CD-2001-2/0 Black P45 (2)	Black (2)	Black 45 (1)
PS3/0	200,000	240,000	CD-720-2 Orange P50 (2)	CD-920-3/0 Orange P50 (1)	Std (1)	CD-2001-3/0 Orange P50 (2)	Orange (2)	Orange 50 (1)
PS4/0	240,000	280,000	CD-720-3 Purple P54 (2)	CD-920-4/0 Purple P54 (1)	Std (1)	CD-2001-4/0 Purple P54 (2)	Purple (2)	Purple 54 (1)

*Half width dies.

**CD-920 Dies can be used with CT-940CH Tool with CD-940-DA Die Adapter.

For use with
Copper
Conductors

Installation Tooling and Die Selections for: Type PS (continued)

Thomas & Betts				Burndy			Anderson	Penn-Union	Greenlee
TBM15, TBM15I, TBM15BSCR	TBM20S, TBM25S	TBM8-750M-1, TBM8-750, TBM8-750BSCR	TBM14M, TBM14BSCR, BPLT14BSCR, 13100A	MY29	Y35, Y35BH, Y39, Y39BH, Y45, Y46, Y750, Y750-2, Y750BH, YY750BH-2, Y750HS, PAT750, BAT35, BAT750	Y644M, Y644MBH, Y644HS, PAT644, BAT644, Y644	VC6	TDY-1	1989
Die Part Number / Color Code & Die Index Number / (Number Of Crimps)									
Red 21 (1)	Red 21 (1)	Std. (1)	Red 21 (1)	#8 (1)	U8CRT Red 49 (1)	—	—	—	—
Blue 24 (1)	Blue 24 (1)	Std. (1)	Blue 24 (1)	#6 (1)	U5CRT Blue 7 (1)	Std. (1)	Std. (1)	—	—
Gray 29 (1)	Gray 29 (1)	Std. (1)	Gray 29 (1)	#4 (1)	U4CRT Gray 8 (1)	Std. (1)	Std. (1)	—	Std. (1)
Brown 33 (1)	Brown 33 (1)	Std. (1)	Brown 33 (1)	#2 (1)	U2CRT Brown 10 (1)	Std. (1)	Std. (1)	Std. (1)	Std. (1)
Green 37 (1)	—	Std. (1)	Green 37 (1)	#1 (1)	U1CRT Green 11 (1)	Std. (1)	Std. (1)	Std. (1)	Std. (1)
Pink 42H* (2)	—	Std. (1)	Pink 42H* (2)	1/0 (1)	U25RT Pink 12 (1)	Std. (1)	Std. (1)	Std. (1)	Std. (1)
Black 45 (1)	—	Std. (1)	Black 45 (1)	2/0 (1)	U26RT Black 13 (1)	Std. (1)	Std. (1)	Std. (1)	Std. (1)
Orange 50 (1)	—	Std. (1)	Orange 50	3/0 (1)	U257RT Orange 14 (1)	Std. (1)	Std. (1)	Std. (1)	Std. (1)
Purple 54H* (2)	—	Std. (1)	Purple 54H* (2)	4/0 (1)	U28RT Purple 15 (1)	Std. (1)	Std. (1)	Std. (1)	Std. (1)

System
Overview

Terminals

Disconnects

Splices

Ferrules

Compression
Connectors

Crimping
Tools

Mechanical
Connectors

Grounding
Connectors

Support
Products

Technical
Info

Index

System Overview

For use with Copper Conductors

Installation Tooling and Die Selections for: Types LCAX, LCAXN, LCBX, LCDX, LCDXN, LCCX, LCEX and LCJX

Terminals

Disconnects

Splices

Ferrules

Compression Connectors

Crimping Tools

Mechanical Connectors

Grounding Connectors

Support Products

Technical Info

Index

PANDUIT® (See Crimping Tools Tab — Section G)

PANDUIT® Part Number	Std. Wire Size	Cable Classes	Wire Strip Length (In.)	CT-1700***	CT-2001, CT-2002	CT-920, CT-920CH, CT-2920, CT-930, CT-930CH, CT-2930, CT-2931, CT-2940*, CT-940CH*
				Die Part Number / Color Code & Die Index Number (Number Of Crimps)		
LCAX8, LCDX8, LCDXN8, LCEX8, LCJX8	8 AWG	Compact, B, G, H, I, K, M, Locomotive (DLO)	1/2	Red P21 (2)	CD-2001-8 Red P21 (1)	CD-920-8 Red P21 (1)
			3/4	Red P21 (3)	CD-2001-8 Red P21 (2)	
LCBX8, LCCX8						
LCAX6, LCDX6, LCDXN6, LCEX6, LCJX6	6 AWG	Compact, B, G, H, I, K, M, Locomotive (DLO)	9/16	Blue P24 (2)	CD-2001-6 Blue P24 (1)	CD-920-6 Blue P24 (1)
			1-1/8	Blue P24 (3)	CD-2001-6 Blue P24 (2)	
LCBX6, LCCX6						
LCAX4, LCDX4, LCDXN4, LCEX4, LCJX4	4 AWG	Compact, B, G, H, I, K, M	5/8	Gray P29 (2)	CD-2001-4 Gray P29 (1)	CD-920-4 Gray P29 (1)
	5, 4, 3 AWG	Locomotive (DLO)				
LCBX4, LCCX4	4 AWG	Compact, B, G, H, I, K, M	1-1/8	Gray P29 (3)	CD-2001-4 Gray P29 (2)	
	5, 4, 3 AWG	Locomotive (DLO)				
LCAX2, LCDX2, LCDXN2, LCEX2, LCJX2	2 AWG	Compact, B, G, H, I, K, M, Locomotive (DLO)	11/16	Brown P33 (2)	CD-2001-2 Brown P33 (1)	CD-920-2 Brown P33 (1)
			1-7/16	Brown P33 (3)	CD-2001-2 Brown P33 (2)	
LCBX2, LCCX2						
LCAX1, LCDX1, LCDXN1, LCEX1, LCJX1	1 AWG	Compact, B, G, H, I, K, M, Locomotive (DLO)	3/4	—	CD-2001-1 Green P37 (1)	CD-920-1 Green P37 (1)
			1-1/2		CD-2001-1 Green P37 (2)	CD-920-1 Green P37 (2)
LCBX1, LCCX1						
LCAX1/0, LCDX1/0, LCDXN1/0, LCEX1/0, LCJX1/0	1/0 AWG	Compact, B, G, H, I, K, M, Locomotive (DLO)	3/4	—	CD-2001-1/0 Pink P42 (2)	CD-920-1/0 Pink P42 (1)
			1-9/16		CD-2001-1/0 Pink P42 (3)	CD-920-1/0 Pink P42 (3)
LCBX1/0, LCCX1/0						
LCAX2/0, LCDX2/0, LCDXN2/0, LCEX2/0, LCJX2/0	2/0 AWG	Compact, B, G, H, I, K, M, Locomotive (DLO)	7/8	—	CD-2001-2/0 Black P45 (2)	CD-920-2/0 Black P45 (1)
			1-9/16		CD-2001-2/0 Black P45 (3)	CD-920-2/0 Black P45 (3)
LCBX2/0, LCCX2/0						
LCAX3/0, LCDX3/0, LCDXN3/0, LCEX3/0, LCJX3/0	3/0 AWG	Compact, B, G, H, I, K, M, Locomotive (DLO)	1	—	CD-2001-3/0 Orange P50 (2)	CD-920-3/0 Orange P50 (1)
			1-5/8		CD-2001-3/0 Orange P50 (3)	CD-920-3/0 Orange P50 (3)
LCBX3/0, LCCX3/0						

*CD-920 Dies can be used with CT-940CH and CT2940 tools with CD-940-DA Die Adapter.

**CD-940 dies to be used with CT-940CH and CT-2940 tools.

***CT-1700 crimp die pockets are integrated into the tool frame.

For use with
Copper
Conductors

Installation Tooling and Die Selections for: Types LCAX, LCAXN, LCBX, LCDX, LCDXN, LCCX, LCEX and LCJX (continued)

PANDUIT® Part Number	Std. Wire Size	Cable Classes	Wire Strip Length. (In.)	PANDUIT® Tool Part Number		
				CT-1700***	CT-2001, CT-2002	CT-920, CT-920CH, CT-2920, CT-930, CT-930CH, CT-2930, CT-2931, CT-2940*, CT-940CH*
						Die Part Number / Color Code & Die Index Number / (Number Of Crimps)
LCAX4/0, LCDX4/0, LCDXN4/0, LCEX4/0, LCJX4/0	4/0	Compact, B, G, H, I, K, M, Locomotive (DLO)	1-1/16	—	CD-2001-4/0 Purple P54 (2)	CD-920-4/0 Purple P54 (1)
LCBX4/0, LCCX4/0			2-5/16		CD-2001-4/0 Purple P54 (3)	CD-920-4/0 Purple P54 (3)
LCAX250, LCAXN250, LCDX250, LCDXN250 LCEX250, LCJX250	250 kcmil	G, H, I, K, M	1-1/16	—	CD-2001-250 Yellow P62 (2)	CD-920-250 Yellow P62 (1)
LCBX250, LCCX250	262.6 kcmil	Locomotive (DLO)	2-5/16		CD-2001-250 Yellow P62 (3)	CD-920-250 Yellow P62 (3)
LCAX300, LCDX300, LCDXN300, LCEX300, LCJX300	300 kcmil 313.1 kcmil	G, H, I, K, M Locomotive (DLO)	1-1/4	—	CD-2001-350 Red P71 (2)	CD-920-350 Red P71 (2)
LCBX300, LCCX300	300 kcmil 313.1 kcmil	G, H, I, K, M Locomotive (DLO)	2-3/8		CD-2001-350 Red P71 (4)	CD-920-350 Red P71 (3)
LCAX350, LCDX350, LCDXN350, LCEX350, LCJX350	350 kcmil 373.7 kcmil	G, H, I, K, M Locomotive (DLO)	1-3/8	—	CD-2001-400 Blue P76 (2)	CD-920-400 Blue P76 (2)
LCBX350, LCCX350	350 kcmil 373.7 kcmil	G, H, I, K, M Locomotive (DLO)	2-9/16		CD-2001-400 Blue P76 (4)	CD-920-400 Blue P76 (3)
LCAX450, LCDX450, LCDXN450, LCEX450, LCJX450	450 kcmil 444.4 kcmil	G, H, I, K, M Locomotive (DLO)	1-7/16	—	—	CD-920-500 Brown P87 (2)
LCBX450, LCCX450	450 kcmil 444.4 kcmil	G, H, I, K, M Locomotive (DLO)	2-3/4	—	—	CD-920-500 Brown P87 (4)
LCAX500, LCDX500, LCDXN500, LCEX500, LCJX500	500 kcmil	G, H, I, K, M	1-9/16	—	—	CD-920-500A Pink P99 (2)
LCBX500, LCCX500	535.3 kcmil	Locomotive (DLO)	2-15/16			CD-920-500A Pink P99 (4)
LCDX600, LCJX600	600 kcmil	G, H, I	1-9/16	—	—	CD-920-500A Pink P99 (2)
LCAX650, LCDX650, LCDXN650, LCEX650, LCJX650	646.4 kcmil	Locomotive (DLO)	1-1/2	—	—	CD-940-750** Black P106 (2)
LCAX750, LCDX750, LCDXN750, LCEX750, LCJX750	777.7 kcmil	Locomotive (DLO)	1-3/4	—	—	CD-940-750X** Yellow P115 (2)

*CD-920 Dies can be used with CT-940CH and CT2940 tools with CD-940-DA Die Adapter.

**CD-940 dies to be used with CT-940CH and CT-2940 tools.

***CT-1700 crimp die pockets are integrated into the tool frame.

System
Overview

Terminals

Disconnects

Splices

Ferrules

Compression
Connectors

Crimping
Tools

Mechanical
Connectors

Grounding
Connectors

Support
Products

Technical
Info

Index

System Overview

For use with Copper Conductors

Installation Tooling and Die Selections for: Types LCAF, LCCF and SCSF

Terminals

Disconnects

Splices

Ferrules

Compression Connectors

Crimping Tools

Mechanical Connectors

Grounding Connectors

Support Products

Technical Info

Index

				PANDUIT® (See Crimping Tools Tab — Section G)			
				CT-1700****		CT-930, CT-930CH, CT-2930, CT-2931, CT-920, CT-920CH, CT-2920, CT-940CH***, CT-2940***	
				Die Part Number / Color Code & Die Index Number / (Number Of Crimps)			
PANDUIT® Part Number	Std. Wire Size	Cable Classes	Wire Strip Length (In.)	for LCAF, SCSF Parts	for LCCF Parts	for LCAF, SCSF Parts	for LCCF Parts
LCAF8 LCCF8 SCSF8	8 AWG	Locomotive (DLO)	13/16 11/16	Red P21 (2)	Red P21 (3)	CD-920-8 Red P21 (1)	
LCAF6 LCCF6 SCSF6	6 AWG	K, M, Locomotive (DLO)	7/8 1-5/16 13/16	Blue P24 (2)	Blue P24 (3)	CD-920-6 Blue P24 (1)	CD-920-6 Blue P24 (2)
LCAF4 LCCF4 SCSF4	4 AWG	K, M, Locomotive (DLO)	7/8 1-5/16 13/16	Gray P29 (2)	Gray P29 (3)	CD-920-4 Gray P29 (1)	CD-920-4 Gray P29 (2)
LCAF2 LCCF2 SCSF2	2 AWG	K, M, Locomotive (DLO)	15/16 1-7/16 7/8	Brown P33 (2)	Brown P33 (3)	CD-920-2 Brown P33 (1)	CD-920-2 Brown P33 (2)
LCAF1 LCCF1 SCSF1	1 AWG	K, M, Locomotive (DLO)	1 1-1/2 7/8	—	—	CD-920-1/0 Pink P42 (1)	CD-920-1/0 Pink P42 (2)
LCAF1/0 LCCF1/0 SCSF1/0	1/0 AWG	K, M, Locomotive (DLO)	1-7/16 1-9/16 1-3/16	—	—	CD-920-2/0 Black P45 (2)	
LCAF2/0 LCCF2/0 SCSF2/0	2/0 AWG	K, M, Locomotive (DLO)	1-7/16 1-9/16 1-3/16	—	—	CD-920-3/0 Orange P50 (2)	
LCAF3/0 LCCF3/0 SCSF3/0	3/0 AWG	K, M, Locomotive (DLO)	1-7/16 1-5/8 1-3/16	—	—	CD-920-4/0 Purple P54 (2)	
LCAF4/0 LCCF4/0 SCSF4/0	4/0 AWG	K, M, Locomotive (DLO)	1-7/16 1-11/16 1-3/16	—	—	CD-920-250 Yellow P62 (2)	

*CD-940 dies to be used exclusively with CT-940CH and CT-2940 tools.

**Can only be crimped with CT-940CH and CT-2940 tools.

***CD-920 dies can be used with the CT-940CH and CT-2940 tools with CD-940-DA die adapter.

****CT-1700 crimp die pockets are integrated into the tool frame.

For use with
Copper
Conductors

Installation Tooling and Die Selections for: Types LCAF, LCCF and SCSF (continued)

				PANDUIT® (See Crimping Tools Tab — Section G)			
				CT-1700****		CT-930, CT-930CH, CT-2930, CT-2931, CT-920, CT-920CH, CT-2920, CT-940CH***, CT-2940****	
PANDUIT® Part Number	Std. Wire Size	Cable Classes	Wire Strip Length (In.)	Die Part Number / Color Code & Die Index Number / (Number Of Crimps)			
				for LCAF, SCSF Parts	for LCCF Parts	for LCAF, SCSF Parts	for LCCF Parts
LCAF250	250 kcmil	K, M, Locomotive (DLO)	1-3/4	—	—	CD-920-300 White P66 (2)	CD-920-300 White P66 (3)
	262.6 kcmil						
LCCF250	250 kcmil		2-5/16				
	262.6 kcmil						
SCSF250	250 kcmil		1-3/16				
	262.6 kcmil						
LCAF300	300 kcmil	K, M, Locomotive (DLO)	1-3/4	—	—	CD-920-350 Red P71 (2)	CD-920-350 Red P71 (3)
	313.1 kcmil						
LCCF300	300 kcmil		2-3/8				
	313.1 kcmil						
SCSF300	300 kcmil		1-1/4				
	313.1 kcmil						
LCAF350	350 kcmil	K, M, Locomotive (DLO)	1-5/16	—	—	CD-920-400 Blue P76 (2)	CD-920-400 Blue P76 (3)
	373.7 kcmil						
LCCF350	350 kcmil		2-9/16				
	373.7 kcmil						
SCSF350	350 kcmil		1-1/2				
	373.7 kcmil						
LCAF400	400 kcmil	K, M, Locomotive (DLO)	2-1/4	—	—	CD-920-500 Brown P87 (2)	CD-920-500 Brown P87 (3)
	444.4 kcmil						
LCCF400	400 kcmil		2-3/4				
	444.4 kcmil						
SCSF400	400 kcmil		1-11/16				
	444.4 kcmil						
LCAF500	500 kcmil	K, M, Locomotive (DLO)	2-5/16	—	—	CD-920-500A Pink P99 (2)	CD-920-500A Pink P99 (3)
	535.3 kcmil						
LCCF500	500 kcmil		2-15/16				
	535.3 kcmil						
SCSF500	500 kcmil		1-5/8				
	535.3 kcmil						
LCAF600**	646.4 kcmil	Locomotive (DLO)	2-3/8	—	—	CD-920-750 Black P106 (2)	CD-920-750 Black P106 (3)
LCCF600**			3				
SCSF600**			1-5/8				
LCAF750**	777.7 kcmil	Locomotive (DLO)	2-7/16	—	—	CD-940-800* Orange P107 (2)	CD-940-800* Orange P107 (4)
LCCF750**			3-1/16				
SCSF750**			1-5/8				

*CD-940 dies to be used exclusively with CT-940CH and CT-2940 tools.

**Can only be crimped with CT-940CH and CT-2940 tools.

***CD-920 dies can be used with the CT-940CH and CT-2940 tools with CD-940-DA die adapter.

****CT-1700 crimp die pockets are integrated into the tool frame.

System
Overview

Terminals

Disconnects

Splices

Ferrules

Compression
Connectors

Crimping
Tools

Mechanical
Connectors

Grounding
Connectors

Support
Products

Technical
Info

Index

System Overview

**For use with
Copper
Conductors**

Installation Tooling and Die Selections for: Type RSC In-Line Reducing Splice

Terminals

Disconnects

Splices

Ferrules

Compression Connectors

Crimping Tools

Mechanical Connectors

Grounding Connectors

Support Products

Technical Info

Index

PANDUIT® Part Number	Reducing From			Reducing To		
	Standard Wire Size	Cable Classes	Wire Strip Length (In.)	Standard Wire Size	Cable Classes	Wire Strip Length (In.)
RSC4-6	4-3 AWG 2 Solid	B, C, Compact	1	6 AWG	B, C, Compact	1-5/16
RSC2-6	2 AWG	B, C, Compact	1	6 AWG	B, C, Compact	1-5/16
RSC2-4	2 AWG	B, C, Compact	1	4-3 AWG 2 Solid	B, C, Compact	1-5/16
RSC1/0-6	1/0 AWG	B, C, Compact	1	6 AWG	B, C, Compact	1-5/16
RSC1/0-4	1/0 AWG	B, C, Compact	1	4-3 AWG 2 Solid	B, C, Compact	1-5/16
RSC2/0-6	2/0 AWG	B, C, Compact	1-1/16	6 AWG	B, C, Compact	1-5/16
RSC2/0-4	2/0 AWG	B, C, Compact	1-1/16	4-3 AWG 2 Solid	B, C, Compact	1-5/16
RSC4/0-6	4/0 AWG	B, C, Compact	1-1/16	6 AWG	B, C, Compact	1-5/16
RSC4/0-4	4/0 AWG	B, C, Compact	1-1/16	4-3 AWG 2 Solid	B, C, Compact	1-5/16
RSC4/0-1/0	4/0 AWG	B, C, Compact	1-1/16	1/0 AWG	B, C, Compact	1-9/16
RSC4/0-2/0	4/0 AWG	B, C, Compact	1-1/16	2/0 AWG	B, C, Compact	1-7/16
RSC500-X4/0	500 kcmil	B, C, Compact	1-7/8	4/0 AWG	I	1-7/16
RSC500-X350	500 kcmil	B, C, Compact	1-7/8	350 kcmil	I	1-7/8
RSC750-4/0	750 kcmil	B, C, Compact	2	4/0 AWG	B, C, Compact	1-5/8
RSC750-X4/0	750 kcmil	B, C, Compact	2	4/0 AWG	I	1-7/16
RSC750-X350	750 kcmil	B, C, Compact	2	350 AWG	I	1-7/8
RSC750-500	750 kcmil	B, C, Compact	2	500 kcmil	B, C, Compact	1-7/8
RSC750-X500	750 kcmil	B, C, Compact	2	500 kcmil	I	2
RSC750-750	750 kcmil	B, C, Compact	2	750 kcmil	B, C, Compact	2
RSCX750-4/0	750 kcmil	I	2	4/0 AWG	B, C, Compact	1-5/8
RSCX750-750	750 kcmil	I	2	750 kcmil	B, C, Compact	2

*CT-1700 crimp die pockets are integrated into the tool head.
 **CD-920 Dies can be used with CT-940CH Tool and CT-2940 Tool with CD-940-DA Die Adapter.
 ^CD-940 Dies to be used with CT-940CH and CT-2940 Tool.
 ‡Maximum conductor size: 500 flex I and 750 kcmil.
 ††Maximum conductor size: 250 flex I and 400 kcmil.

For use with
Copper
Conductors

Installation Tooling and Die Selections for: Type RSC In-Line Reducing Splice (continued)

PANDUIT® (See Crimping Tools Tab — Section G)							
CT-1700*		CT-720		CT-2001, CT-2000		CT-930‡, CT-930CH‡, CT-920‡‡, CT-920CH‡‡, CT-2920‡‡, CT-2940**, CT-940CH**, CT-2930‡, CT-2931‡	
Reducing From	Reducing To	Reducing From	Reducing To	Reducing From	Reducing To	Reducing From	Reducing To
Die Part Number / Color Code & Die Index Number (Number Of Crimps)							
Gray P29 (2)	Blue P24 (2)	CD-720-1 Gray P29 (1)	CD-720-1 Blue P24 (1)	CD-2001-4 Gray P29 (1)	CD-2001-6 Blue P24 (1)	CD-920-4 Gray P29 (1)	CD-920-6 Blue P24 (1)
Brown P33 (2)	Blue P24 (2)	CD-720-1 Brown P33 (1)	CD-720-1 Blue P24 (1)	CD-2001-2 Brown P33 (1)	CD-2001-6 Blue P24 (1)	CD-920-2 Brown P33 (1)	CD-920-6 Blue P24 (1)
Brown P33 (2)	Gray P29 (2)	CD-720-1 Brown P33 (1)	CD-720-1 Gray P29 (1)	CD-2001-2 Brown P33 (1)	CD-2001-4 Gray P29 (1)	CD-920-2 Brown P33 (1)	CD-920-4 Gray P29 (1)
—	—	CD-720-2 Pink P42 (1)	CD-720-1 Blue P24 (1)	CD-2001-1/0 Pink P42 (1)	CD-2001-6 Blue P24 (1)	CD-920-1/0 Pink P42 (1)	CD-920-6 Blue P24 (1)
—	—	CD-720-2 Pink P42 (1)	CD-720-1 Gray P29 (1)	CD-2001-1/0 Pink P42 (1)	CD-2001-4 Gray P29 (1)	CD-920-1/0 Pink P42 (1)	CD-920-4 Gray P29 (1)
—	—	CD-720-2 Black P45 (2)	CD-720-1 Blue P24 (1)	CD-2001-2/0 Black P45 (2)	CD-2001-6 Blue P24 (1)	CD-920-2/0 Black P45 (1)	CD-920-6 Blue P24 (1)
—	—	CD-720-2 Black P45 (2)	CD-720-1 Gray P29 (1)	CD-2001-2/0 Black P45 (2)	CD-2001-4 Gray P29 (1)	CD-920-2/0 Black P45 (1)	CD-920-4 Gray P29 (1)
—	—	CD-720-3 Purple P54 (2)	CD-720-1 Blue P24 (1)	CD-2001-4/0 Purple P54 (2)	CD-2001-6 Blue P24 (1)	CD-920-4/0 Purple P54 (1)	CD-920-6 Blue P24 (1)
—	—	CD-720-3 Purple P54 (2)	CD-720-1 Gray P29 (1)	CD-2001-4/0 Purple P54 (2)	CD-2001-4 Gray P29 (1)	CD-920-4/0 Purple P54 (1)	CD-920-4 Gray P29 (1)
—	—	CD-720-3 Purple P54 (2)	CD-720-2 Pink P42 (2)	CD-2001-4/0 Purple P54 (2)	CD-2001-1/0 Pink P42 (2)	CD-920-4/0 Purple P54 (1)	CD-920-1/0 Pink P42 (2)
—	—	CD-720-3 Purple P54 (2)	CD-720-2 Black P45 (2)	CD-2001-4/0 Purple P54 (2)	CD-2001-2/0 Black P45 (2)	CD-920-4/0 Purple P54 (1)	CD-920-2/0 Black P45 (2)
—	—	CD-720-7 Brown P87 (2)	CD-720-3 Yellow P62 (2)	CD-2001-500 Brown P87 (3)	CD-2001-250 Yellow P62 (2)	CD-920-500 Brown P87 (2)	CD-920-250 Yellow P62 (2)
—	—	CD-720-7 Brown P87 (2)	CD-720-6 Blue P76 (2)	CD-2001-500 Brown P87 (3)	CD-2001-400 Blue P76 (3)	CD-920-500 Brown P87 (2)	CD-920-400 Blue P76 (2)
—	—	—	—	—	—	CD-920-750, CD-940-750^ Black P106 (2)	CD-920-4/0 Purple P54 (1)
—	—	—	—	—	—	CD-920-750, CD-940-750^ Black P106 (2)	CD-920-250 Yellow P62 (1)
—	—	—	—	—	—	CD-920-750, CD-940-750^ Black P106 (2)	CD-920-400 Blue P76 (2)
—	—	—	—	—	—	CD-920-750, CD-940-750^ Black P106 (2)	CD-920-500 Brown P87 (2)
—	—	—	—	—	—	CD-920-750, CD-940-750^ Black P106 (2)	CD-920-500A Pink P99 (2)
—	—	—	—	—	—	CD-920-750, CD-940-750^ Black P106 (2)	CD-920-750 CD-940-750^ Black P106 (2)
—	—	—	—	—	—	CD-940-750X^ Yellow P115 (2)	CD-920-4/0 Purple P54 (1)
—	—	—	—	—	—	CD-940-750X^ Yellow P115 (2)	CD-940-750^ Black 106 (2)

For Burndy Tooling, see pages L28, L29. For Thomas & Betts Tooling, see pages L30, L31.

System
Overview

Terminals

Disconnects

Splices

Ferrules

Compression
Connectors

Crimping
Tools

Mechanical
Connectors

Grounding
Connectors

Support
Products

Technical
Info

Index

System Overview

**For use with
Copper
Conductors**

Installation Tooling and Die Selections for: Type RSC In-Line Reducing Splice (continued)

Terminals

Disconnects

Splices

Ferrules

Compression Connectors

Crimping Tools

Mechanical Connectors

Grounding Connectors

Support Products

Technical Info

Index

PANDUIT® Part Number	Reducing From			Reducing To		
	Standard Wire Size	Cable Classes	Wire Strip Length (In.)	Standard Wire Size	Cable Classes	Wire Strip Length (In.)
RSC4-6	4-3 AWG 2 Solid	B, C, Compact	1	6 AWG	B, C, Compact	1-5/16
RSC2-6	2 AWG	B, C, Compact	1	6 AWG	B, C, Compact	1-5/16
RSC2-4	2 AWG	B, C, Compact	1	4-3 AWG 2 Solid	B, C, Compact	1-5/16
RSC1/0-6	1/0 AWG	B, C, Compact	1	6 AWG	B, C, Compact	1-5/16
RSC1/0-4	1/0 AWG	B, C, Compact	1	4-3 AWG 2 Solid	B, C, Compact	1-5/16
RSC2/0-6	2/0 AWG	B, C, Compact	1-1/16	6 AWG	B, C, Compact	1-5/16
RSC2/0-4	2/0 AWG	B, C, Compact	1-1/16	4-3 AWG 2 Solid	B, C, Compact	1-5/16
RSC4/0-6	4/0 AWG	B, C, Compact	1-1/16	6 AWG	B, C, Compact	1-5/16
RSC4/0-4	4/0 AWG	B, C, Compact	1-1/16	4-3 AWG 2 Solid	B, C, Compact	1-5/16
RSC4/0-1/0	4/0 AWG	B, C, Compact	1-1/16	1/0 AWG	B, C, Compact	1-9/16
RSC4/0-2/0	4/0 AWG	B, C, Compact	1-1/16	2/0 AWG	B, C, Compact	1-7/16
RSC500-X4/0	500 kcmil	B, C, Compact	1-7/8	4/0 AWG	I	1-7/16
RSC500-X350	500 kcmil	B, C, Compact	1-7/8	350 kcmil	I	1-7/8
RSC750-4/0	750 kcmil	B, C, Compact	2	4/0 AWG	B, C, Compact	1-5/8
RSC750-X4/0	750 kcmil	B, C, Compact	2	4/0 AWG	I	1-7/16
RSC750-X350	750 kcmil	B, C, Compact	2	350 AWG	I	1-7/8
RSC750-500	750 kcmil	B, C, Compact	2	500 kcmil	B, C, Compact	1-7/8
RSC750-X500	750 kcmil	B, C, Compact	2	500 kcmil	I	2
RSC750-750	750 kcmil	B, C, Compact	2	750 kcmil	B, C, Compact	2
RSCX750-4/0	750 kcmil	I	2	4/0 AWG	B, C, Compact	1-5/8
RSCX750-750	750 kcmil	I	2	750 kcmil	B, C, Compact	2

For use with
Copper
Conductors

Installation Tooling and Die Selections for: Type RSC In-Line Reducing Splice (continued)

Burndy					
Y1MR, Y2MR		Y1MRTC		Y35, Y35BH, Y39, Y39BH, Y45, Y46, Y750, Y750HS, Y750-2, Y750BH-2, BAT35, BAT750, PAT644, PAT750	
Reducing From	Reducing To	Reducing From	Reducing To	Reducing From	Reducing To
Die Part Number / Color Code & Die Index Number (Number Of Crimps)					
Gray (2)	Blue (3)	White (2)	Blue (3)	U4CR Gray 8 (1)	U5CRT Blue 7 (1)
Brown (2)	Blue (3)	Brown (2)	Blue (3)	U2CRT Brown 10 (1)	U5CRT Blue 7 (1)
Brown (2)	Gray (3)	Brown (2)	White (3)	U2CRT Brown 10 (1)	U4CRT Gray 8 (1)
—	—	—	—	U25RT Pink 12 (1)	U5CRT Blue 7 (1)
—	—	—	—	U25RT Pink 12 (1)	U4CRT Gray 8 (1)
—	—	—	—	U26RT Black 13 (1)	U5CRT Blue 7 (1)
—	—	—	—	U26RT Black 13 (1)	U4CRT Gray 8 (1)
—	—	—	—	U28RT Purple 15 (1)	U5CRT Blue 7 (1)
—	—	—	—	U28RT Purple 15 (1)	U4CRT Gray 8 (1)
—	—	—	—	U28RT Purple 15 (1)	U25RT Pink 12 (2)
—	—	—	—	U28RT Purple 15 (1)	U26RT Black 13 (1)
—	—	—	—	U34RT Brown 20 (2)	U29RT Yellow 16 (1)
—	—	—	—	U34RT Brown 20 (2)	U32RT Blue 19 (2)
—	—	—	—	U39RT Black 24 (3)	U28RT Purple 15 (1)
—	—	—	—	U39RT Black 24 (3)	U29RT Yellow 16 (1)
—	—	—	—	U39RT Black 24 (3)	U32RT Blue 19 (2)
—	—	—	—	U39RT Black 24 (3)	U34RT Brown 20 (2)
—	—	—	—	U39RT Black 24 (3)	U38XRT Pink L99 (3)
—	—	—	—	U39RT Black 24 (3)	U39RT Black 24 (3)
—	—	—	—	—	—
—	—	—	—	—	—

System
Overview

Terminals

Disconnects

Splices

Ferrules

Compression
Connectors

Crimping
Tools

Mechanical
Connectors

Grounding
Connectors

Support
Products

Technical
Info

Index

System Overview

**For use with
Copper
Conductors**

Installation Tooling and Die Selections for: Type RSC In-Line Reducing Splice (continued)

Terminals

Disconnects

Splices

Ferrules

Compression Connectors

Crimping Tools

Mechanical Connectors

Grounding Connectors

Support Products

Technical Info

Index

PANDUIT® Part Number	Reducing From			Reducing To		
	Standard Wire Size	Cable Classes	Wire Strip Length (In.)	Standard Wire Size	Cable Classes	Wire Strip Length (In.)
RSC4-6	4-3 AWG 2 Solid	B, C, Compact	1	6 AWG	B, C, Compact	1-5/16
RSC2-6	2 AWG	B, C, Compact	1	6 AWG	B, C, Compact	1-5/16
RSC2-4	2 AWG	B, C, Compact	1	4-3 AWG 2 Solid	B, C, Compact	1-5/16
RSC1/0-6	1/0 AWG	B, C, Compact	1	6 AWG	B, C, Compact	1-5/16
RSC1/0-4	1/0 AWG	B, C, Compact	1	4-3 AWG 2 Solid	B, C, Compact	1-5/16
RSC2/0-6	2/0 AWG	B, C, Compact	1-1/16	6 AWG	B, C, Compact	1-5/16
RSC2/0-4	2/0 AWG	B, C, Compact	1-1/16	4-3 AWG 2 Solid	B, C, Compact	1-5/16
RSC4/0-6	4/0 AWG	B, C, Compact	1-1/16	6 AWG	B, C, Compact	1-5/16
RSC4/0-4	4/0 AWG	B, C, Compact	1-1/16	4-3 AWG 2 Solid	B, C, Compact	1-5/16
RSC4/0-1/0	4/0 AWG	B, C, Compact	1-1/16	1/0 AWG	B, C, Compact	1-9/16
RSC4/0-2/0	4/0 AWG	B, C, Compact	1-1/16	2/0 AWG	B, C, Compact	1-7/16
RSC500-X4/0	500 kcmil	B, C, Compact	1-7/8	4/0 AWG	I	1-7/16
RSC500-X350	500 kcmil	B, C, Compact	1-7/8	350 kcmil	I	1-7/8
RSC750-4/0	750 kcmil	B, C, Compact	2	4/0 AWG	B, C, Compact	1-5/8
RSC750-X4/0	750 kcmil	B, C, Compact	2	4/0 AWG	I	1-7/16
RSC750-X350	750 kcmil	B, C, Compact	2	350 AWG	I	1-7/8
RSC750-500	750 kcmil	B, C, Compact	2	500 kcmil	B, C, Compact	1-7/8
RSC750-X500	750 kcmil	B, C, Compact	2	500 kcmil	I	2
RSC750-750	750 kcmil	B, C, Compact	2	750 kcmil	B, C, Compact	2
RSCX750-4/0	750 kcmil	I	2	4/0 AWG	B, C, Compact	1-5/8
RSCX750-750	750 kcmil	I	2	750 kcmil	B, C, Compact	2

For use with
Copper
Conductors

Installation Tooling and Die Selections for: Type RSC In-Line Reducing Splice (continued)

Thomas & Betts							
TBM20S, TBM25S		TBM5, TBM6, TBM8		TBM12, 13642M		TBM14BSCR, BPLT14BSCR, 13100A, TBM14M	
Reducing From	Reducing To	Reducing From	Reducing To	Reducing From	Reducing To	Reducing From	Reducing To
Color Code, Die Index Number (Number Of Crimps)							
Gray (2)	Blue (3)	Gray (1)	Blue (1)	Gray 29 (1)	Blue 24 (1)	Gray 29 (1)	Blue 24 (1)
Brown (2)	Blue (3)	Brown (1)	Blue (1)	Brown 33 (1)	Blue 24 (1)	Brown 33 (1)	Blue 24 (1)
Brown (2)	Gray (3)	Brown (1)	Gray (1)	Brown 33 (1)	Gray 29 (1)	Brown 33 (1)	Gray 29 (1)
—	—	Pink (1)	Blue (1)	Pink 42 (1)	Blue 24 (1)	Pink 42H* (2)	Blue 24 (1)
—	—	Pink (1)	Gray (1)	Pink 42 (1)	Gray 29 (1)	Pink 42H* (2)	Gray 29 (1)
—	—	Black (2)	Blue (1)	Black/Gold 45 (1)	Blue 24 (1)	Black 45 (1)	Blue 24 (1)
—	—	Black (2)	Gray (1)	Black/Gold 45 (1)	Gray 29 (1)	Black 45 (1)	Gray 29 (1)
—	—	Purple (2)	Blue (1)	Purple/Olive 54 (1)	Blue 24 (1)	Olive 54H* (2)	Blue 24 (1)
—	—	Purple (2)	Gray (1)	Purple/Olive 54 (1)	Gray 29 (1)	Olive 54H* (2)	Gray 29 (1)
—	—	Purple (2)	Pink (2)	Purple/Olive 54 (1)	Pink 42 (2)	Olive 54H* (2)	Pink 42H* (4)
—	—	Purple (2)	Black (2)	Purple/Olive 54 (1)	Black/Gold 45 (1)	Olive 54H* (2)	Black 45 (1)
—	—	—	—	Brown 87H* (2)	Yellow 62 (1)	Brown 87H* (2)	Yellow 62 (1)
—	—	—	—	Brown 87H* (2)	Blue 76H* (2)	Brown 87H* (2)	Blue 76 (1)
—	—	—	—	Black/Orange 106H* (2)	Purple/Olive 54 (1)	Black 106H* (2)	Olive 54H* (2)
—	—	—	—	Black/Orange 106H* (2)	Yellow 62 (1)	Black 106H* (2)	Yellow 62 (1)
—	—	—	—	Black/Orange 106H* (2)	Blue 76H* (2)	Black 106H* (2)	Blue 76 (1)
—	—	—	—	Black/Orange 106H* (2)	Brown 87H* (2)	Black 106H* (2)	Brown 87H* (2)
—	—	—	—	Black/Orange 106H* (2)	Pink 99H (2)	Black 106H* (2)	Pink 99H (2)
—	—	—	—	Black/Orange 106H* (2)	Black/Orange 106H* (2)	Black 106H* (2)	Black 106H* (2)
—	—	—	—	—	—	—	—
—	—	—	—	—	—	—	—

*Half width dies.

For PANDUIT® Tooling, see pages L26, L27. For Burndy Tooling, see pages L28, L29.

For service and technical support, call 800-777-3300 (outside the U.S. and Canada, see back cover).

System
Overview

Terminals

Disconnects

Splices

Ferrules

Compression
Connectors

Crimping
Tools

Mechanical
Connectors

Grounding
Connectors

Support
Products

Technical
Info

Index

System Overview

For use with Copper Conductors

Installation Tooling and Die Selections for: Type CTAPF

Terminals

Disconnects

Splices

Ferrules

Compression Connectors

Crimping Tools

Mechanical Connectors

Grounding Connectors

Support Products

Technical Info

Index

PANDUIT® Part Number		Stranded Wire Size (AWG)		PANDUIT® (See Crimping Tools Tab — Section G)			
		Main	Tap	1700**	CT-920, CT-920CH, CT-2920, CT-930, CT-930CH, CT-2930, CT-2931, CT-940CH*, CT-2940*	CT-2001, CT-2002	
Die Part Number / Color Code & Die Index Number / (Number of Crimps)							
CTAPF10-16	14	16-14		Red P21 (2)	—	—	CD-2001-8 Red P21 (1)
	12	16-12					
	10	14					
CTAPF8-12	10	10		Blue P24 (2)	—	—	CD-2001-6 Blue P24 (1)
	8	12					
CTAPF6-12	8	8-12		Gray P29 (2)	—	—	CD-2001-4 Gray P29 (1)
	6	12-10					
CTAPF4-12	6	8-6		Brown P33 (4)	CDM-920-2 Brown P33M (1)	CDM-2001-2 Brown P33M (1)	CD-2001-2 Brown P33 (2)
	5,4	12-8					
CTAPF3-12	5,4	6-5		Green P37 (4)	CDM-920-1 Green P37M (1)	CDM-2001-1 Green P37M (1)	CD-2001-1 Green P37 (2)
	3	12-6					
CTAPF2-12	4	4		—	CDM-920-1/0 Pink P42M (1)	CDM-2001-1/0 Pink P42M (1)	CD-2001-1/0 Pink P42 (2)
	3	5					
	2	12-6					
CTAPF1-12	3	4-3		—	CDM-920-2/0 Black P45M (1)	CDM-2001-2/0 Black P45M (2)	CD-2001-2/0 Black P45 (3)
	2	5-4					
	1	12-5					
CTAPF1/0-12	2	4-2		—	CDM-920-3/0 Orange P50M (1)	CDM-2001-3/0 Orange P50M (2)	CD-2001-3/0 Orange P50 (3)
	1	4-3					
	1/0	12-4					
CTAPF2/0-12	1	2-1		—	CDM-920-4/0 Purple P54M (1)	—	CD-2001-4/0 Purple P54 (3)
	1/0	3-2					
	2/0	12-3					
CTAPF3/0-12	1/0	1-1/0		—	CDM-920-250 Yellow P62M (1)	—	CD-2001-250 Yellow P62 (3)
	2/0	2-1					
	3/0	12-2					

*CT-940CH and CT-2940 require CD-940-DA adapter for CDM-920 dies.

**The CT-1700 crimp die pockets are integrated into the tool head.

For use with
Copper
Conductors

Installation Tooling and Die Selections for: Type CTAPF (continued)

PANDUIT® Part Number	Stranded Wire Size (AWG)		Burndy		Thomas & Betts
			Y35, Y39, Y45, Y46, Y750BH-2, Y750, BAT35, BAT750, Y35BH, Y39BH, Y750BH, Y750HS, PAT750, Y750-2	Y500CT - HS BCT500 - HS BCT500, Y500CT	TBM8-75, TBM8-750-1, TBM8-750BSCR
	Main	Tap	Die Part Number / Die Color & Die Index Number / (Number of Crimps)		
CTAPF10-16	14	16-14	—	—	—
	12	16-12	—	—	—
	10	14	—	—	—
CTAPF8-12	10	10	—	—	—
	8	12	—	—	—
CTAPF6-12	8	8-12	—	—	—
	6	12-10	—	—	—
CTAPF4-12	6	8-6	UC4 Brown 10M (1)	WC4 Brown 10M (1)	TBM8-750C20 (1)
	5,4	12-8	—	—	—
CTAPF3-12	5,4	6-5	—	—	TBM8-750C2530 (1)
	3	12-6	—	—	—
CTAPF2-12	4	4	UC2 Pink 12M (1)	WC2 Pink 12M (1)	TBM8-750C2530 (1)
	3	5	—	—	—
	2	12-6	—	—	—
CTAPF1-12	3	4-3	UC1 Black 13M (1)	WC1 Black 13M (2)	TBM8-750C3540 (1)
	2	5-4	—	—	—
	1	12-5	—	—	—
CTAPF1/0-12	2	4-2	UC25 Orange 14M (1)	WC25 Orange 14M (2)	TBM8-750C3540 (1)
	1	4-3	—	—	—
	1/0	12-4	—	—	—
CTAPF2/0-12	1	2-1	—	—	TBM8-750C4550 (1)
	1/0	3-2	—	—	—
CTAPF3/0-12	2/0	12-3	—	—	—
	1/0	1-1/0	—	—	TBM8-750C4550 (1)
	2/0	2-1	—	—	—
	3/0	12-2	—	—	—

System
Overview

Terminals

Disconnects

Splices

Ferrules

Compression
Connectors

Crimping
Tools

Mechanical
Connectors

Grounding
Connectors

Support
Products

Technical
Info

Index

System Overview

For use with Copper Conductors

Installation Tooling and Die Selections for: Type CTAP

Terminals

Disconnects

Spllices

Ferrules

Compression Connectors

Crimping Tools

Mechanical Connectors

Grounding Connectors

Support Products

Technical Info

Index

PANDUIT® Part Number	Conductor Size		Wire Strip Length (In.)	PANDUIT® <i>(See Crimping Tools Tab — Section G)</i>		Burndy	
	Main	Tap		CT-920, CT-920CH, CT-930, CT-2920, CT-930CH, CT-2930, CT2931, CT-940CH*, CT-2940*	CT-2001, CT-2002	MD6, MD7	BAT35, BAT750, PAT750, Y35, Y35BH, Y39, Y39BH, Y45, Y46, Y750, Y750HS, Y750BH
Crimp Die Number / Index No. or Color Code (No. Of Crimps)							
CTAP4/0-4/0	3/0 – 4/0 AWG Stranded	3/0 – 4/0 AWG Stranded	1-1/4	CD-920-D3 Blue (1)	—	—	U-F (2) U-D3 (1)
CTAP4/0-2/0	3/0 – 4/0 AWG Stranded	1/0 – 2/0 AWG Stranded	1-1/4	CD-920-D3 Blue (1)	—	—	U-F (2) U-D3 (1)
CTAP4/0-2	3/0 – 4/0 AWG Stranded	6 – 2 AWG Solid or Stranded	1-1/4	CD-920-D3 Blue (1)	—	—	U-F (2) U-D3 (1)
CTAP2/0-2/0	1/0 – 2/0 AWG Stranded	1/0 – 2/0 AWG Stranded	1-1/16	CD-920-0 Green (1)	—	—	U-O (1) U-E (3)
CTAP2/0-2	1/0 – 2/0 AWG Stranded	8 – 2 AWG Solid or Stranded	1-1/16	CD-920-0 Green (1)	—	—	U-O (1) U-E (3)
CTAP2-2	2 AWG Solid or Stranded	2 AWG Solid or Stranded	7/8	CD-920-C (1)	CD-2001-C (2)	W-C Brown (2)	U-C (1)
CTAP2-4	2 AWG Solid or Stranded	8 – 4 AWG Solid or Stranded	7/8	CD-920-C (1)	CD-2001-C (2)	W-C Brown (2)	U-C (1)
CTAP4-4	4 AWG Solid or Stranded	4 AWG Stranded	3/4	CD-920-BG (1)	CD-2001-BG (1)	W-BG-(1) BG (2)	U-BG (1)
CTAP4-6	6 AWG Stranded, 4 AWG Solid or Stranded	6 AWG Solid or Stranded	3/4	CD-920-BG (1)	CD-2001-BG (1)	W-BG (1) BG (2)	U-BG (1)
CTAP4-8	6 – 4 AWG Solid or Stranded	8 AWG Solid or Stranded	3/4	CD-920-BG (1)	CD-2001-BG (1)	W-BG (1) BG (2)	U-BG (1)

*CT-940CH and CT-2940 require CD-940-DA adapter for CD-920 dies.

For use with
Copper
Conductors

Installation Tooling and Die Selections for: Type HTCT

PANDUIT® Part Number	Copper Conductor Sizes (Code Cable)				Copper Conductor Sizes (Flex Cable) Types G, H, I, K, M & Locomotive (DLO)				Crimp Die Color Code	Installation Tools		
	Main	Tap 1	Tap 2	Tap 3	Main	Tap 1	Tap 2	Tap 3		15 TON	14 TON	12 TON
										PANDUIT® (See Crimping Tools Tab — Section G)		
										CT-940CH* CT-2940*	CT-930 CT-930CH CT-2930	CT-920 CT-920CH CT-2920
										Burndy		
										Y46*, Y46C*	—	Y35, Y35-2, Y35BH, Y35BH-4, Y750, Y39, Y39BH, Y750-2, Y750BH, Y750BH-2, Y750HS, BAT35, BAT750, PAT750C, PAT750
										Thomas & Betts		
										TBM15I, TBM15BSCR	TBM14M, TBM14BSCR, BPLT14BSCR, 13100A	—
										Die Part Number, Die Index No. (Number of Crimps = 1)		
HTCT8-8	8-14 AWG	8-14 AWG	—	—	8-14 AWG	8-14 AWG	—	—	Green	CD-920H-8 PH8	CD-920H-8 PH8	CD-920H-8 PH8
HTCT6-6	6-10 AWG	6-14 AWG	—	—	6-10 AWG	6-14 AWG	—	—	Orange	CD-920H-6 PH6	CD-920H-6 PH6	CD-920H-6 PH6
HTCT2-2	2-6 AWG STR/SOL	2-6 AWG STR/SOL	8-14 AWG	8-14 AWG	2-8 AWG	2-8 AWG	8-14 AWG	8-14 AWG	Brown	CD-920H-2 PH2	CD-920H-2 PH2	CD-920H-2 PH2
HTCT250-8	250 kcmil -2 AWG	8-14 AWG	8-14 AWG	—	4/0-2 AWG	8-14 AWG	8-14 AWG	—	Purple	CD-930H-250 PH25	CD-930H-250 PH25	—
HTCT250-2	250 kcmil -2 AWG	2-6 AWG STR/SOL	8-14 AWG	—	4/0-2 AWG	2-8 AWG	8-14 AWG	—	Purple	CD-930H-250 PH25	CD-930H-250 PH25	—
HTCT250-250	250 kcmil -2 AWG	250 kcmil -2 AWG	—	—	4/0-2 AWG	4/0-2 AWG	—	—	Purple	CD-930H-250 PH25	CD-930H-250 PH25	—
HTCT500-250	500 kcmil -4/0 AWG	250 kcmil -1/0 AWG	1-6 AWG STR/SOL	8-14 AWG	373 kcmil -4/0 AWG	4/0-1/0 AWG	1-8 AWG	8-14 AWG	Brown	CD-940H-500 PH50	—	—
HTCT500-500	500-250 kcmil	500 kcmil -4/0 AWG	—	—	373 kcmil -4/0 AWG	373 kcmil -4/0 AWG	—	—	Brown	CD-940H-500 PH50	—	—
HTCT750-4/0	750-350 kcmil	4/0-1/0 AWG	1-6 AWG STR/SOL	2-14 AWG	550-500 kcmil	250 kcmil -1/0 AWG	1-8 AWG	2-14 AWG	Yellow	CD-940H-750 PH75	—	—
HTCT750-750	750-500 kcmil	750-350 kcmil	—	—	550-444 kcmil	550-313 kcmil	—	—	Yellow	CD-940H-750 PH75	—	—
HTCT1000-250	1000-750 kcmil	250 kcmil -1/0 AWG	1-2 AWG	—	777-500 kcmil	4/0-1/0 AWG	1-2 AWG	—	Yellow	CD-940H-750 PH75	—	—
HTCT1000-1000	1000-750 kcmil	1000-750 kcmil	—	—	777-750 kcmil 777-500 kcmil	777-500 kcmil 350 kcmil	—	—	White	CD-940H-1000 PH10	—	—

*CT-940CH and CT-2940 PANDUIT tools and Y46 and Y46C Burndy tools require CD-940-DA adapter for CD-920H and CD-930H dies. PANDUIT crimping dies must be used with all tooling (PANDUIT and competitor) to maintain UL/CSA certification for applications up to 600V.

System
Overview

Terminals

Disconnects

Splices

Ferrules

Compression
Connectors

Crimping
Tools

Mechanical
Connectors

Grounding
Connectors

Support
Products

Technical
Info

Index

System Overview

For use with Copper or Aluminum Conductors

Installation Tooling and Die Selections for: Type SAR

Terminals

Disconnects

Splices

Ferrules

Compression Connectors

Crimping Tools

Mechanical Connectors

Grounding Connectors

Support Products

Technical Info

Index

PANDUIT® (See Crimping Tools Tab — Section G)

PANDUIT® Part Number	Aluminum Wire Size	Aluminum or Copper Wire Size	Wire Strip Length (both ends) In.	CT-720	CT-2001, CT-2002	CT-980, CT-980CH, CT-2980, CT-2981, CT-980LPCH	CT-920, CT-920CH, CT-930, CT-930CH, CT-2930, CT-2931, CT-930LPCH, CT-2920, CT940CH**, CT-2940**
				Die Part Number / Color Code & Die Index Number / (Number Of Crimps)			
SAR2-4	2 AWG	4 AWG	2-1/16	CD-720-2 Tan P50 (3)	CD-2001-3/0 Tan P50 (3)	Std. (2)	CD-920-3/0 Tan P50 (2)
SAR1/0-2	1/0 AWG	2 AWG	2-1/16	CD-720-2 Tan P50 (3)	CD-2001-3/0 Tan P50 (3)	Std. (2)	CD-920-3/0 Tan P50 (2)
SAR3/0-1/0	3/0 AWG	1/0 AWG	2-5/16	CD-720-5 Red P71 (3)	CD-2001-350 Red P71 (4)	Std. (2)	CD-920-350 Red P71 (2)
SAR4/0-2/0	4/0 AWG	2/0 AWG	2-3/16	CD-720-5 Red P71 (3)	CD-2001-350 Red P71 (4)	Std. (2)	CD-920-350 Red P71 (2)
SAR350-4/0	350 kcmil	4/0 AWG	3-3/16	CD-720-7 Brown P87 (4)	—	Std. (2)	CD-920-500 Brown P87 (4)
SAR500-350	500 kcmil	350 kcmil	4-1/4	—	—	—	CD-920-500A Pink P99 (4)
SAR600-500	600 kcmil	500 kcmil	4	—	—	—	CD-920-750, CD-940-750‡ Black P106 (4)
SAR750-600	750 kcmil	600 kcmil	4-3/8	—	—	—	CD-940-750A‡ Red P125 (4)

PANDUIT® Part Number	Aluminum Wire Size	Aluminum or Copper Wire Size	Wire Strip Length (both ends) In.	Thomas & Betts		Burdndy			Anderson	
				TBM5	TBM8	TBM15, TBM15I, TBM15BSCR	MY29	Y35, Y39, Y750, Y750-HS, BAT35, BAT750, PAT750, Y35BH, Y39BH, Y750BH, Y750-2, Y750BH-2	Y45, Y46	VC6
Die Part Number / Color Code & Die Index Number / (Number Of Crimps)										
SAR2-4	2 AWG	4 AWG	2-1/16	Tan 50 (3)	Tan 50 (3)	Tan 50 (2)	1/0 AL (1)	U25ART Tan 296 (2)	U25ART Tan 296 (2)	Std. (1)
SAR1/0-2	1/0 AWG	2 AWG	2-1/16	Tan 50 (3)	Tan 50 (3)	Tan 50 (2)	1/0 AL (1)	U25ART Tan 296 (2)	U25ART Tan 296 (2)	Std. (1)
SAR3/0-1/0	3/0 AWG	1/0 AWG	2-5/16	—	Red 71 (4)	Red 71H* (4)	—	U29ART Red 324 (2)	U29ART Red 324 (2)	Std. (2)
SAR4/0-2/0	4/0 AWG	2/0 AWG	2-3/16	—	Red 71 (4)	Red 71H* (4)	—	U29ART Red 324 (2)	U29ART Red 324 (2)	Std. (2)
SAR350-4/0	350 kcmil	4/0 AWG	3-3/16	—	Brown 87 (4)	Brown 87H* (4)	—	U31ART Brown 299 (2)	U31ART Brown 299 (2)	Std. (2)
SAR500-350	500 kcmil	350 kcmil	4-1/4	—	—	Pink 99H* (4)	—	U34ART Pink 300 (4)	U34ART Pink 300 (4)	—
SAR600-500	600 kcmil	500 kcmil	4	—	—	Black 106 (3)	—	U36ART Black 473 (4)	U36ART Black 473 (4)	—
SAR750-600	750 kcmil	600 kcmil	4-3/8	—	—	Yellow 115H* (4)	—	—	P39ART Red 301 (4)	—

*Half width dies.

**CD-920 dies can be used with CT-940CH & CT-2940 tools with CD-940-DA die adapter. Maximum size splice is 250 kcmil with PANDUIT® CT-920, CT-920CH and CT-2920 Tools and Burndy Y35, Y35BH & BAT35 tools.

‡CD-940 dies to be used exclusively with CT-940CH & CT-2940 tools.

For use with
Copper or
Aluminum
Conductors

Installation Tooling and Die Selections for: Type HTAP

PANDUIT® Part Number	Conductor Sizes		PANDUIT® (See Crimping Tools Tab — Section G)	
			CT-2001 CT-2002	CT-920, CT-920CH, CT-930, CT-930CH, CT-2920, CT-2930, CT-2931, CT-2940**, CT-940CH***
	Run	Tap	Die Part Number / Color Code & Die Index Number / (Number of Crimps)	
HTAP2-8	2-6 AWG str. 1-6 AWG sol.	8-14 AWG str. 7-14 AWG sol.	CD-2001-3/0 Orange P50 (2)	CD-920-3/0 (1)
HTAP1-1	1-6 AWG str. 2-6AWG sol.	1-6 AWG str. 2-6 AWG sol.	CD-2001-0 Green P0 (4)	CD-920-0 (1)
HTAP1/0-1	1/0-6 AWG str. 2-6 AWG sol.	1-6 AWG str. 2-6 AWG sol.	CD-2001-0 Green P0 (4)	CD-920-0 (1)
HTAP2/0-1	2/0-2 AWG str. 2 AWG sol.	1-6 AWG str. 2-6 AWG sol.	CD-2001-0 Green P0 (4)	CD-920-0 (1)
HTAP3/0-1	3/0-1/0 AWG str. 4/0-3/0 AWG sol.	1-6 AWG str. 2-6 AWG sol.	CD-2001-D3* (4)	CD-920-D3 (1)
HTAP3/0-3/0	3/0-1/0 AWG str. 4/0-3/0 AWG sol.	3/0-1/0 AWG str. 4/0-3/0 AWG sol.	CD-2001-D3* (5)	CD-920-D3 (1)
HTAP4/0-2	4/0-3/0 AWG str.	1-6 AWG str. 2-6 AWG sol.	CD-2001-D3* (4)	CD-920-D3 (1)
HTAP4/0-3/0	4/0-3/0 AWG str.	3/0-1 AWG str.	CD-2001-D3* (6)	CD-920-D3 (1)
HTAP4/0-4/0	4/0-3/0 AWG str.	4/0-3/0 AWG str.	CD-2001-D3* (7)	CD-920-D3 (2)
HTAP500-4/0	500 kcmil str. - 4/0 AWG str.	4/0-1/0 AWG str.	—	CD-930-N CD-940-N** (3)
HTAP500-500	500 kcmil str. - 4/0 AWG str.	500 kcmil str. - 4/0-1/0 AWG str.	—	CD-930-N CD-940-N** (2)

*Built into the CT-2001 Crimp Tool.

**CD-940 dies to be used exclusively with CT-940CH or CT-2940 Crimp Tools.

***CD-920 and CD-930 dies can be used with CT-940CH or CT-2940 Crimp Tools with CD-940-DA die adapter.

System
Overview

Terminals

Disconnects

Splices

Ferrules

Compression
Connectors

Crimping
Tools

Mechanical
Connectors

Grounding
Connectors

Support
Products

Technical
Info

Index

System Overview

For use with Copper or Aluminum Conductors

Installation Tooling and Die Selections for: Type BPC

Terminals

PANDUIT® (See Crimping Tools Tab — Section G)

Disconnects

PANDUIT® Part Number	Standard Wire Size	Wire Strip Length (In.)	CT-720	CT-2001, CT-2002	CT-980, CT-980CH, CT-2980, CT-2981	CT-930, CT-930CH, CT-2930, CT-2931, CT-920, CT-920CH, CT-2940**, CT-2920, CT-940CH**
			Die Part Number / Color Code & Die Index Number / (Number Of Crimps)			
BPC6	6 AWG	1-1/16	CD-720-2 Tan P50 (2)	CD-2001-3/0 Tan P50 (2)	STD (1)	CD-920-3/0 Tan P50 (2)
BPC4	4 AWG	1-1/16	CD-720-2 Tan P50 (2)	CD-2001-3/0 Tan P50 (2)	STD (1)	CD-920-3/0 Tan P50 (2)
BPC2	2 AWG	1-1/16	CD-720-2 Tan P50 (2)	CD-2001-3/0 Tan P50 (2)	STD (1)	CD-920-3/0 Tan P50 (2)
BPC1	1 AWG	1-1/16	CD-720-2 Tan P50 (2)	CD-2001-3/0 Tan P50 (2)	STD (1)	CD-920-3/0 Tan P50 (2)
BPC1/0	1/0 AWG	1-5/16	CD-720-5 Red P71 (2)	CD-2001-350 Red P71 (3)	STD (2)	CD-920-350 Red P71 (2)
BPC2/0	2/0 AWG	1-5/16	CD-720-5 Red P71 (2)	CD-2001-350 Red P71 (3)	STD (2)	CD-920-350 Red P71 (2)
BPC3/0	3/0 AWG	1-5/16	CD-720-5 Red P71 (2)	CD-2001-350 Red P71 (3)	STD (2)	CD-920-350 Red P71 (2)
BPC4/0	4/0 AWG	1-5/16	CD-720-5 Red P71 (2)	CD-2001-350 Red P71 (3)	STD (2)	CD-920-350 Red P71 (2)
BPC250	250 kcmil	1-7/16	—	—	STD (2)	CD-920-800 Green P94 (2)
BPC300	300 kcmil	1-7/16	—	—	STD (2)	CD-920-800 Green P94 (2)
BPC350	350 kcmil	1-7/16	—	—	STD (2)	CD-920-800 Green P94 (2)
BPC400	400 kcmil	1-7/16	—	—	STD (2)	CD-920-750, CD-940-750‡ Black P106 (2)
BPC500	500 kcmil	1-7/16	—	—	STD (2)	CD-920-750, CD-940-750‡ Black P106 (2)
BPC600	600 kcmil	1-15/16	—	—	—	CD-940-750A‡ Red P125 (2)
BPC750	750 kcmil	1-15/16	—	—	—	CD-940-750A‡ Red P125 (2)

*Half width dies.

**CD-920 Dies can be used with CT940CH Tool with CD-940-DA Die Adapter. Maximum size splice is 250 kcmil with CT-920, CT-920CH and CT-2920 Tools.

‡CD-940 Dies to be used exclusively with CT-940CH Tool.

Index

For use with
Copper or
Aluminum
Conductors

Installation Tooling and Die Selections for: Type BPC (continued)

Thomas & Betts			Burndy		
13642M	TBM8	TBM15, TBM15I, TBM15BSCR	Y35, BAT35, Y750, Y750-HS, Y750BH, Y750-2, PAT750, Y750BH-2, BAT750	Y39, Y45, Y46, Y39BH	Y644M, Y644-HS, PAT644, BAT644, Y644MBH
Die Part Number / Color Code & Die Index Number / (Number Of Crimps)					
Orange 50 (2)	Tan 50 (2)	Orange 50 (2)	U25ART Tan 296 (2)	U25ART Tan 296 (2)	STD (1)
Orange 50 (2)	Tan 50 (2)	Orange 50 (2)	U25ART Tan 296 (2)	U25ART Tan 296 (2)	STD (1)
Orange 50 (2)	Tan 50 (2)	Orange 50 (2)	U25ART Tan 296 (2)	U25ART Tan 296 (2)	STD (1)
Orange 50 (2)	Tan 50 (2)	Orange 50 (2)	U25ART Tan 296 (2)	U25ART Tan 296 (2)	STD (1)
Blue 76H* (2)	Blue 76 (2)	Blue 76 (2)	U28ART White 298 (2)	U28ART White 298 (2)	STD (1)
Blue 76H* (2)	Blue 76 (2)	Blue 76 (2)	U28ART White 298 (2)	U28ART White 298 (2)	STD (1)
Blue 76H* (2)	Blue 76 (2)	Blue 76 (2)	U28ART White 298 (2)	U28ART White 298 (2)	STD (1)
Blue 76H* (2)	Blue 76 (2)	Blue 76 (2)	U28ART White 298 (2)	U28ART White 298 (2)	STD (1)
Pink 99H* (2)	Brown 87 (3)	Brown 87H* (2)	U31ART Brown 299 (2)	U31ART Brown 299 (2)	STD (1)
Pink 99H* (2)	Brown 87 (3)	Brown 87H* (2)	U31ART Brown 299 (2)	U31ART Brown 299 (2)	STD (1)
Pink 99H* (2)	Brown 87 (3)	Brown 87H* (2)	U31ART Brown 299 (2)	U31ART Brown 299 (2)	STD (1)
Black 106H* (3)	—	Black 106H* (3)	U34ART Pink 300 (3)	U34ART Pink 300 (3)	STD (1)
Black 106H* (3)	—	Black 106H* (3)	U34ART Pink 300 (3)	U34ART Pink 300 (3)	STD (1)
Yellow 115H* (3)	—	Yellow 115H* (3)	—	U39ART-2 Yellow 936 (3)	—
Yellow 115H* (3)	—	Yellow 115H* (3)	—	U39ART-2 Yellow 936 (3)	—

System
Overview

Terminals

Disconnects

Splices

Ferrules

Compression
Connectors

Crimping
Tools

Mechanical
Connectors

Grounding
Connectors

Support
Products

Technical
Info

Index

System Overview

For use with Copper or Aluminum Conductors

Installation Tooling and Die Selections for: Types LAA, LAB and SA

Terminals

Disconnects

Splices

Ferrules

Compression Connectors

Crimping Tools

Mechanical Connectors

Grounding Connectors

Support Products

Technical Info

Index

			PANDUIT® (See Crimping Tools Tab — Section G)		
PANDUIT® Part Number L=Lugs S=Splice	Std. Wire Size	Wire Strip Length (In.)	CT-1700***	CT-720	CT-930, CT-930CH, CT-920, CT-920CH, CT-2920, CT-2930, CT-2931, CT-2940**, CT940CH**
			Die Part Number / Color Code & Die Index Number / (Number Of Crimps)		
LAA6	6 AWG	1	Gray P29 (5)	CD-720-1 Gray P29 (2)	CD-920-4 Gray P29 (2)
SA6		3/4			
LAA4	4 AWG	1-1/16	Green P37 (5)	CD-720-2 Green P37 (2)	CD-920-1 Green P37 (2)
SA4		7/8			
LAA2	2 AWG	1	—	CD-720-2 Pink P42 (2)	CD-920-1/0 Pink P42 (2)
SA2		7/16			
LAA1	1 AWG	1	—	CD-720-2 Gold P45 (3)	CD-920-2/0 Gold P45 (2)
SA1		7/16			
LAA1/0 LAB1/0	1/0 AWG	1-9/16	—	CD-720-2 Tan P50 (3)	CD-920-3/0 Tan P50 (2)
SA1/0		1			
LAA2/0 LAB2/0	2/0 AWG	1-9/16	—	CD-720-3 Olive P54 (3)	CD-920-4/0 Olive P54 (2)
SA2/0		1-1/8			
LAA3/0 LAB3/0	3/0 AWG	1-9/16	—	CD-720-3 Ruby P60 (4)	CD-920-250 Ruby P60 (2)
SA3/0		1-1/4			
LAA4/0 LAB4/0	4/0 AWG	1-3/4	—	CD-720-4 White P66 (4)	CD-920-300 White P66 (2)
SA4/0		1-5/16			
LAA250 LAB250	250 kcmil	1-3/4	—	CD-720-5 Red P71 (4)	CD-920-350 Red P71 (2)
SA250		1-7/16			
LAA300 LAB300	300 kcmil	2-5/16	—	CD-720-6 Blue P76 (4)	CD-920-400 Blue P76 (2)
SA300		1-1/2			
LAA350 LAB350	350 kcmil	2-5/16	—	CD-720-7 Brown P87 (4)	CD-920-500 Brown P87 (2)
SA350		1-5/8			
LAA400 LAB400	400 kcmil	2-9/16	—	—	CD-920-800 Green P94 (4)
SA400		1-13/16			
LAA500 LAB500	500 kcmil	3-1/16	—	—	CD-920-500A Pink P99 (4)
SA500		1-7/8			
LAA600 LAB600	600 kcmil	3-1/16	—	—	CD-920-750, CD-940-750‡ Black P106 (4)
SA600		2			
LAA750 LAB750	750 kcmil	3-7/16	—	—	CD-940-750A‡ Red P125 (4)
SA750		2-1/4			
LAA800 LAB800	800 kcmil	3-7/16	—	—	CD-940-800A‡ Gray P140 (4)
SA800		2-5/16			
LAA1000 LAB1000	1000 kcmil	4-3/4	—	—	CD-940-1000A‡ Brown P161 (4)
SA1000		2-9/16			

*Half width dies.

**CD-920 Dies can be used with CT-940CH Tool with CD-940-DA Die Adapter. Maximum size splice is 250 kcmil with CT-920, CT-920CH and CT-2920 Tools.

***CT-1700 Crimp Pockets are integrated into the tool head.

‡CT-940 Dies to be used exclusively with CT-940CH Tool.

For use with
Copper or
Aluminum
Conductors

Installation Tooling and Die Selections for: Types LAA, LAB and SA (continued)

PANDUIT® Part Number L = Lugs S = Splice	Std. Wire Size	Wire Strip Length (In.)	Thomas & Betts			Burndy				Anderson
			TBM5	TBM8	TBM15, TBM15I, TBM15BSCR	MY29	Y35	Y39	Y45, Y46	VC8
			Die Part Number / Color Code & Die Index Number / (Number Of Crimps)							
LAA6	6 AWG	1	Gray 29 (2)	Gray 29 (2)	Gray 29 (2)	6AL (1)	U6CABT Gray 346 (1)	U6CABT Gray 346 (1)	U6CABT Gray 346 (1)	Std. (1)
SA6		3/4								
LAA4	4 AWG	1-1/16	Green 37 (2)	Green 37 (2)	Green 37 (2)	4AL (1)	U4CABT Green 375 (1)	U4CABT Green 375 (1)	U4CABT Green 375 (1)	Std. (1)
SA4		7/8								
LAA2	2 AWG	1	Pink 42 (3)	Pink 42 (3)	Pink 42 (2)	2AL (1)	U2CABT Pink 348 (2)	U2CABT Pink 348 (2)	U2CABT Pink 348 (2)	Std. (1)
SA2		7/16								
LAA1	1 AWG	1	Gold 45 (3)	Gold 45 (3)	Gold 45 (2)	1AL (1)	U1CART Gold 471 (2)	U1CART Gold 471 (2)	U1CART Gold 471 (2)	Std. (1)
SA1		7/16								
LAA1/0 LAB1/0 SA1/0	1/0 AWG	1-9/16	Tan 50 (3)	Tan 50 (3)	Tan 50 (2)	1/0AL (1)	U25ART Tan 298 (2)	U25ART Tan 298 (2)	U25ART Tan 298 (2)	Std. (2)
		1								
LAA2/0 LAB2/0 SA2/0	2/0 AWG	1-9/16	Olive 54 (3)	Olive 54 (3)	Olive 54 (3)	2/0AL (2)	U26ART Olive 297 (2)	U26ART Olive 297 (2)	U26ART Olive 297 (2)	Std. (2)
		1-1/8								
LAA3/0 LAB3/0 SA3/0	3/0 AWG	1-9/16	Ruby 60 (4)	Ruby 60 (4)	Ruby 60 (2)	3/0AL (2)	U27ART Ruby 467 (2)	U27ART Ruby 467 (2)	U27ART Ruby 467 (2)	Std. (2)
		1-1/4								
LAA4/0 LAB4/0 SA4/0	4/0 AWG	1-3/4	—	White 66 (4)	White 66 (2)	4/0AL (2)	U28ART White 298 (2)	U28ART White 298 (2)	U28ART White 298 (2)	Std. (2)
		1-5/16								
LAA250 LAB250 SA250	250 kcmil	1-3/4	—	Red 71 (4)	Red 71H* (4)	—	U29ART Red 324 (2)	U29ART Red 324 (2)	U29ART Red 324 (2)	Std. (2)
		1-7/16								
LAA300 LAB300 SA300	300 kcmil	2-5/16	—	Blue76 (4)	Blue 76 (2)	—	U30ART Blue 470 (2)	U30ART Blue 470 (2)	U30ART Blue 470 (2)	Std. (2)
		1-1/2								
LAA350 LAB350 SA350	350 kcmil	2-5/16	—	Brown 87 (4)	Brown 87H* (4)	—	U31ART Brown 299 (2)	U31ART Brown 299 (2)	U31ART Brown 299 (2)	Std. (2)
		1-5/8								
LAA400 LAB400 SA400	400 kcmil	2-9/16	—	—	Green 94H* (4)	—	U32ART Green 472 (4)	U32ART Green 472 (4)	U32ART Green 472 (4)	—
		1-13/16								
LAA500 LAB500 SA500	500 kcmil	3-1/16	—	—	Pink 99H* (4)	—	U34ART Pink 300 (4)	U34ART Pink 300 (4)	U34ART Pink 300 (4)	—
		1-7/8								
LAA600 LAB600 SA600	600 kcmil	3-1/16	—	—	Black 106 (3)	—	U36ART Black 473 (4)	U36ART Black 473 (4)	U36ART Black 473 (4)	—
		2								
LAA750 LAB750 SA750	750 kcmil	3-7/16	—	—	Yellow 115H* (4)	—	—	S39ART Red 301 (4)	S39ART Red 301 (4)	—
		2-1/4								
LAA800 LAB800 SA800	800 kcmil	3-7/16	—	—	125H* (4)	—	—	Gray 474 (4)	Gray 474 (4)	—
		2-5/16								
LAA1000 LAB1000 SA1000	1000 kcmil	4-3/4	—	—	161 (5)	—	—	S44ART Brown 302 (4)	S44ART Brown 302 (4)	—
		2-9/16								

System
Overview

Terminals

Disconnects

Splices

Ferrules

Compression
Connectors

Crimping
Tools

Mechanical
Connectors

Grounding
Connectors

Support
Products

Technical
Info

Index

RECOMMENDED TERMINATION HARDWARE

System Overview

Terminals

Disconnects

Splices

Ferrules

Compression Connectors

Crimping Tools

Mechanical Connectors

Grounding Connectors

Support Products

Technical Info

Index

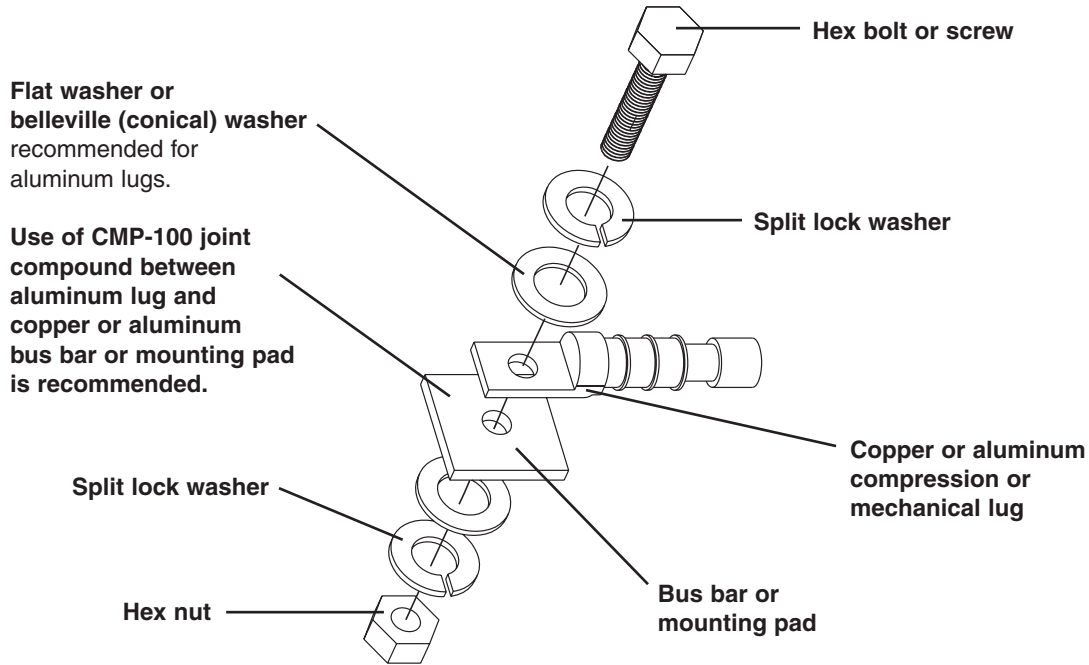
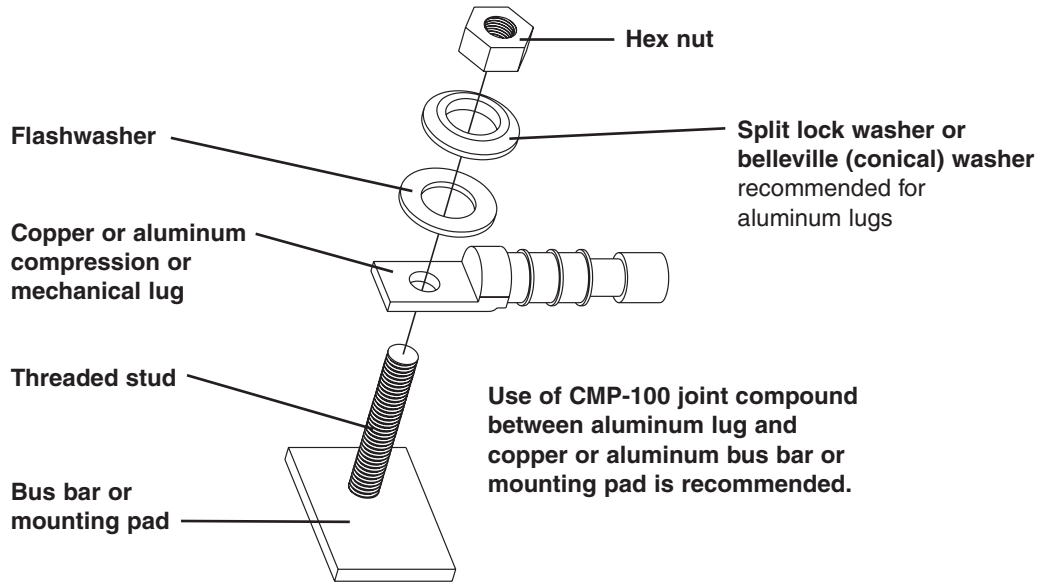

Recommended Hardware Material

Material Configuration of Lug/Mounting Surface

Copper to Copper	Aluminum to Copper	Aluminum to Aluminum	Copper to Steel	Aluminum to Steel
<ol style="list-style-type: none"> Silicon Bronze Stainless Steel 	<ol style="list-style-type: none"> Silicon Bronze Aluminum Stainless Steel 	<ol style="list-style-type: none"> Aluminum Stainless Steel Plated Silicon Bronze 	<ol style="list-style-type: none"> Silicon Bronze Stainless Steel 	<ol style="list-style-type: none"> Aluminum Stainless Steel

Conductor Sizes

Copper Concentric Stranded Conductor Sizes

Conductor Size AWG or kcmil	Number of Strands	Nominal Diameter (In.)	Class
#20	7	.036 /3	B
#18	7	.045 /6	B
#16	7	.057 /6	B
#14	7	.072 /6	B
#12	7	.091 /5	B
#10	7	.116	B
#9	7	.130	B
#8	7	.146	B
#7	7	.164	B
#6	7	.184	B
#5	7	.206	B
#4	3	.254	AA
#4	7	.232	B&A
#3	3	.285	AA
#3	7	.260	B&A
#2	3	.320	AA
#2	7	.292	B&A
#1	3	.360	AA
#1	7	.328	AA
#1	19	.332	B
1/0	7	.368	A&A
1/0	12	.390	—
1/0	19	.373	B
2/0	7	.414	A&A
2/0	12	.438	—
2/0	19	.419	B
3/0	7	.464	A&A
3/0	12	.492	—
3/0	19	.470	B
4/0	7	.522	A&A
4/0	12	.522	—
4/0	19	.528	B
250	12	.600	AA
250	19	.574	A
250	37	.575	B
300	12	.657	AA
300	19	.628	A
300	37	.630	B
350	12	.710	AA
350	19	.679	A
350	37	.681	B
400	19	.726	A&AA
400	37	.728	B
450	19	.770	AA
450	37	.772	B&A
500	19	.811	AA
500	37	.813	B&A
600	37	.891	A&AA
600	61	.893	B
700	37	.963	BB
700	61	.964	B&A
750	37	.977	AA
750	61	.998	B&A
800	37	1.029	AA
800	61	1.031	B&A
900	37	1.092	AA
900	61	1.094	B&A
1000	37	1.151	AA
1000	61	1.152	B&A
1000	61	1.152	B&A

Flexible Copper Conductor Sizes

Conductor Size AWG or kcmil	Number of Strands	Nominal Diameter (In.)	Class
#8	41/.0201	.156	I
#8	49/.0184	.166	G
#8	133/.0111	.167	H
#8	168/.010	.157	K
#8	37	.330	Locomotive (DLO)
#8	420/.0063	.162	M
#7	49/.0206	.185	G
#7	52/.0201	.185	I
#7	133/.0125	.188	H
#7	210/.010	.179	K
#7	—	—	Locomotive (DLO)
#7	532/.0063	.196	M
#6	49/.0231	.208	G
#6	63/.0201	.207	I
#6	133/.0140	.210	H
#6	266/.010	.210	K
#6	61	.410	Locomotive (DLO)
#6	665/.0063	.215	M
#5	49/.0260	.234	G
#5	84/.0201	.235	I
#5	133/.0158	.237	H
#5	336/.010	.235	K
#5	—	—	Locomotive (DLO)
#5	836/.0063	.240	M
#4	49/.0292	.263	G
#4	105/.0201	.263	I
#4	133/.0177	.266	H
#4	420/.010	.272	K
#4	105	.460	Locomotive (DLO)
#4	1064/.0063	.269	M
#3	49/.0328	.295	G
#3	133/.0199	.299	H
#3	133/.0201	.291	I
#3	532/.010	.304	K
#3	125	.480	Locomotive (DLO)
#3	1323/.0063	.305	M
#2	49/.0368	.331	G
#2	133/.0223	.335	H
#2	161/.0201	.319	I
#2	665/.010	.338	K
#2	150	.510	Locomotive (DLO)
#2	1666/.0063	.337	M
#1	133/.0251	.337	G
#1	210/.0201	.367	I
#1	259/.018	.378	H
#1	836/.010	.397	K
#1	225	.650	Locomotive (DLO)
#1	2107/.0063	.376	M
1/0	133/.0282	.423	G
1/0	259/.0202	.424	H
1/0	266/.0201	.441	I
1/0	1064/.010	.451	K
1/0	275	.680	Locomotive (DLO)
1/0	2646/.0063	.423	M
2/0	133/.0316	.474	G
2/0	259/.0227	.477	H
2/0	342/.0201	.500	I
2/0	1323/.010	.470	K
2/0	325	.720	Locomotive (DLO)
2/0	3325/.0063	.508	M

System
Overview

Terminals

Disconnects

Splices

Ferrules

Compression
Connectors

Crimping
Tools

Mechanical
Connectors

Grounding
Connectors

Support
Products

Technical
Info

Index

System Overview

Conductor Sizes (continued)

Flexible Copper Conductor Sizes

Conductor Size AWG or kcmil	No. of Strands/ Strand Dia.	Nominal Diameter (In.)	Class
3/0	133/.0355	.533	G
3/0	259/.0255	.536	H
3/0	418/.0201	.549	I
3/0	1666/.010	.533	K
3/0	450	.810	Locomotive (DLO)
3/0	4256/.0063	.576	M
4/0	133/.0399	.599	G
4/0	259/.0286	.601	H
4/0	532/.0201	.613	I
4/0	2107/.010	.627	K
4/0	550	.840	Locomotive (DLO)
4/0	5320/.0063	.645	M
250	259/.0311	.650	G
250	427/.0242	.653	H
250	637/.0201	.682	I
250	2499/.010	.682	K
262.6	650	.960	Locomotive (DLO)
250	6384/.0063	.713	M
300	259/.0340	.714	G
300	427/.0265	.716	H
300	735/.0201	.737	I
300	2989/.010	.768	K
313.1	775	1.040	Locomotive (DLO)
300	7581/.0063	.768	M
350	259/.0368	.773	G
350	427/.0268	.772	H
350	882/.0201	.800	I
350	3458/.010	.809	K
373.7	925	1.140	Locomotive (DLO)
350	8806/.0063	.825	M
400	259/.0393	.825	G
400	427/.0306	.826	H
400	980/.0201	.831	I
400	3990/.010	.878	K
400	—	—	Locomotive (DLO)
400	10101/.0063	.901	M
450	259/.0417	.876	G
450	427/.325	.878	H
450	1127/.0201	.894	I
450	4522/.010	.933	K
444.4	1100	1.230	Locomotive (DLO)
450	11396/.0063	.940	M
500	259/.0439	.922	G
500	427/.0342	.923	H
500	1125/.0201	.941	I
500	5054/.010	.988	K
535.3	1325	1.320	Locomotive (DLO)
500	12691/.0063	.997	M
600	427/.0375	1.013	G
600	703/.0292	1.022	H
600	1470/.0201	1.027	I
600	5985/.010	1.125	K
646.4	1600	1.450	Locomotive (DLO)
600	14945/.0063	1.084	M
700	427/.0405	1.094	G
700	703/.0316	1.106	H
700	1729/.0201	1.194	I
700	6916/.010	1.207	K
777.7	1925	1.540	Locomotive (DLO)
700	17507/.0063	1.183	M

Flexible Copper Conductor Sizes

Conductor Size AWG or kcmil	No. of Strands/Strand Dia.	Nominal Diameter (In.)	Class
800	427/.0433	1.169	G
800	703/.0337	1.180	H
800	1995/.0201	1.290	I
800	7980/.010	1.305	K
800	—	—	Locomotive (DLO)
800	20069/.0063	1.256	M
900	427/.0459	1.239	G
900	703/.0358	1.253	H
900	2261/.0201	1.372	I
900	9065/.010	1.323	K
900	—	—	Locomotive (DLO)
900	22631/.0063	1.331	M
1000	427/.0484	1.307	G
1000	703/.0377	1.320	H
1000	2527/.0201	1.427	I
1000	10101/.010	1.419	K
1000	—	—	Locomotive (DLO)
1000	25193/.0063	1.404	M

Copper Compact Stranded Conductor Sizes

Conductor Size AWG or kcmil	Number of Strands	Conductor Diameter (In.)	Class
#8	7	.134	Compact
#6	7	.169	Compact
#4	7	.213	Compact
#2	7	.268	Compact
#1	19	.299	Compact
1/0	19	.336	Compact
1/0	19	.376	Compact
3/0	19	.423	Compact
4/0	19	.475	Compact
250	37	.520	Compact
300	37	.570	Compact
350	37	.616	Compact
400	37	.659	Compact
450	37	.700	Compact
500	37	.736	Compact
550	61	.775	Compact
600	61	.813	Compact
650	61	.845	Compact
700	61	.877	Compact
750	61	.908	Compact
800	61	.938	Compact
900	61	.999	Compact
1000	61	1.060	Compact

Technical Info

Index

Conductor Sizes (continued)

Copper Solid Conductor Sizes

Solid Copper Conductor Size AWG or kcmil	Conductor Diameter (In.)
#18	.040
#17	.045
#16	.050
#15	.057
#14	.064
#13	.071
#12	.080
#11	.090
#10	.101
#9	.114
#8	.128
#7	.128
#6	.162
#5	.181
#4	.204
#3	.229
#2	.257
#1	.289
1/0	.324
2/0	.364
3/0	.409
4/0	.460

Aluminum Concentric Stranded Conductor Sizes

Class B Aluminum Concentric AWG or kcmil	Number of Strands	Diameter of each Strand (Mils)
#8	7	48.6
#7	7	54.5
#6	7	61.2
#5	7	68.8
#4	7	77.2
#3	7	86.7
#2	7	97.4
#1	19	66.4
1/0	19	74.5
2/0	19	83.7
3/0	19	94.0
4/0	19	105.5
250	37	82.2
300	37	90.0
350	37	97.3
400	37	104.0
450	37	110.3
500	37	116.2
550	61	95.0
600	61	99.2
650	61	103.2
700	61	107.1
750	61	110.9
800	61	114.5
900	61	121.5
1000	61	128.0

Aluminum Compact Stranded Conductor Sizes

Compact Aluminum AWG or kcmil	Class ASTM B400	Number of Strands	Conductor Diameter (In.)
#8	A, B	7	.134
#6	A, B	7	.169
#4	A, B	7	.213
#3	A, B	7	.238
#2	AA, A, B	7	.268
#1	AA, A	7	.299
#1	B	19	.299
1/0	AA, A	7	.336
1/0	B	19	.336
2/0	AA, A	7	.376
2/0	B	19	.376
3/0	AA, A	7	.423
3/0	B	19	.423
4/0	AA, A	7	.475
4/0	B	19	.475
250	AA	7	.520
250	A	19	.520
250	B	37	.520
266	AA	7	.337
266	A	19	.337
300	AA	7	.570
300	A	19	.570
300	B	37	.570
336	AA	7	.603
336	A	19	.603
350	A	19	.616
350	B	37	.616
397	AA, A	19	.659
400	B	37	.659
450	B	37	.700
477	AA	19	.722
500	AA	19	.736
500	B	37	.736
550	B	61	.775
556	AA	19	.780
600	B	61	.813
650	B	61	.845
700	B	61	.877
750	B	61	.908
800	B	61	.938
900	B	61	.999
1000	B	61	1.060

System Overview

Terminals

Disconnects

Splices

Ferrules

Compression Connectors

Crimping Tools

Mechanical Connectors

Grounding Connectors

Support Products

Technical Info

Index

System Overview

Common Conductor Sizes and Strandings Reference Chart

Terminals

Conductor	Individual Strands			Overall Conductor Size			Conductor	Individual Strands			Overall Conductor Size				
	Diameter			Diameter				Diameter			Area				
AWG	Metric mm ²	No.	mm	In.	mm	In.	Circ. MILS	AWG	Metric mm ²	No.	mm	In.	mm	In.	Circ. MILS
Disconnects	0.05	25	.05	.002	.25	.010	97	1.0	19	.25	.010	1.30	.051	1841	
		0.06	41	.05	.002	.36	.014			159	1	1.13	.044	1.13	.044
	26	10	.13	.005	.53	.021	250			32	.20	.008	1.30	.051	1984
		1	.41	.016	.41	.016	256			7	.43	.017	1.30	.051	2006
		7	.16	.006	.48	.019	278			19	.29	.011	1.47	.058	2426
		19	.10	.004	.51	.020	304			65	.16	.006	1.50	.059	2580
Splices	24	41	.08	.003	.58	.023	384	16	*26	.25	.010	1.50	.059	2600	
		10	.16	.006	.58	.023	397		1	1.30	.051	1.30	.051	2601	
		1	.51	.020	.51	.020	400		105	.13	.005	1.50	.059	2625	
		7	.20	.008	.61	.024	448		*7	.51	.020	1.52	.060	2828	
		19	.13	.005	.61	.024	475		30	.25	.010	1.70	.067	2906	
Ferrules	0.25	65	.07	.003	.65	.026	484	1.5	21	.30	.012	1.60	.063	2930	
		128	.05	.002	.65	.026	496		189	.10	.004	1.90	.075	2930	
		32	.10	.004	.65	.026	496		7	.52	.020	1.60	.063	2934	
		14	.16	.006	.65	.026	556		1	1.38	.054	1.38	.054	2952	
		1	.64	.025	.64	.025	625		45	.16	.006	1.85	.073	3786	
Compression Connectors	22	16	.16	.006	.76	.030	635	14	19	.36	.014	1.85	.073	3831	
		26	.13	.005	.76	.030	650		1	1.63	.064	1.63	.064	4096	
		7	.25	.010	.76	.030	700		*41	.25	.010	1.85	.073	4100	
		19	.16	.006	.79	.031	754		*7	.64	.025	1.85	.073	4481	
		48	.10	.004	.80	.031	744		50	.25	.010	2.20	.087	4844	
Crimping Tools	0.38	194	.05	.002	.80	.031	752	2.5	7	.67	.026	2.10	.083	4871	
		100	.07	.003	.80	.031	760		35	.30	.012	2.20	.087	4883	
		7	.27	.011	.80	.031	791		315	.10	.004	2.20	.087	4883	
		12	.21	.008	.80	.031	820		1	1.78	.070	1.78	.070	4911	
		21	.16	.006	.80	.031	833		19	.45	.018	2.36	.093	6088	
Mechanical Connectors	0.5	7	.30	.012	.90	.035	977	12	*65	.25	.010	2.41	.095	6500	
		16	.20	.008	.90	.035	992		165	.16	.006	2.41	.095	6549	
		1	.80	.031	.80	.031	992		1	2.06	.081	2.06	.081	6561	
		*10	.25	.010	.89	.035	1000		*7	.81	.032	2.44	.096	7168	
		1	.81	.032	.81	.032	1024		56	.30	.012	3.10	.122	7812	
Grounding Connectors	20	41	.13	.005	.91	.036	1025	4.0	1	2.26	.089	2.26	.089	7917	
		26	.16	.006	.91	.036	1032		511	.10	.004	3.00	.118	7921	
		*7	.32	.013	.97	.038	1111		19	.52	.020	2.70	.106	7963	
		19	.20	.008	.94	.037	1216		37	.40	.016	2.92	.115	9354	
		7	.37	.015	1.10	.043	1485		49	.36	.014	2.95	.116	9880	
Support Products	0.75	24	.20	.008	1.20	.047	1488	10	*7	.98	.039	2.95	.116	10376	
		1	1.00	.039	1.00	.039	1550		1	2.59	.102	2.59	.102	10404	
		*16	.25	.010	1.19	.047	1600		*105	.25	.010	2.95	.116	10500	
		1	1.02	.040	1.02	.040	1600		84	.30	.012	3.50	.138	11718	
		65	.13	.005	1.19	.047	1625		756	.10	.004	3.70	.146	11718	
Technical Info	18	41	.16	.006	1.19	.047	1627	6.0	1	2.76	.109	2.76	.109	11807	
		*7	.40	.016	1.22	.048	1770		7	1.05	.041	3.20	.126	11962	
		19	.25	.010	1.24	.049	1900		19	.64	.025	3.30	.130	12063	

*Strandings required for UL and CSA Certification testing.

This chart details the different conductors commonly used in the industry. For each size, either AWG or Metric, various stranding options are listed. Typically the higher stranding is used in applications requiring greater conductor flexibility.

AWG to Metric Wire Crosses	
AWG	Metric (mm ²)
26-22	0.1-0.5
22-18	0.5-1.0
16-14	1.5-2.5
12-10	4.0-6.0

Index

Common Conductor Sizes and Strandings Reference Chart (continued)

Conductor		Individual Strands			Overall Conductor Size			Conductor		Individual Strands			Overall Conductor Size		
		No.	Diameter		Diameter		Area			No.	Diameter		Diameter		Area
AWG	Metric mm ²		mm	In.	mm	In.	Circ. MILS	AWG	Metric mm ²		mm	In.	mm	In.	Circ. MILS
	6	7	.107	.042	3.21	.126	11840		95	19	2.57	.101	12.8	.505	187500
		1	2.77	.109	2.77	.109	11840			37	1.83	.072	12.5	.504	187500
9		7	1.1	.0432	3.3	.13	13000	4/0		19	2.89	.1055	13.4	.528	211600
		1	2.91	.1144	2.91	.114	13090			37	2.06	.081	14.4	.567	237.8 kcmil
8		1	3.26	.1285	3.25	.128	16510	250 kcmil		37	2.07	.0822	14.6	.575	250 kcmil
		7	1.23	.0486	3.7	.146	16510	300 kcmil		150	37	2.29	.09	16	.63
	10	7	1.37	.054	4.12	.162	19740	350 kcmil		37	2.47	.0973	17.3	.681	350 kcmil
		1	3.58	.141	3.58	.141	19740			185	37	2.54	.1	17.8	.7
7		7	1.38	.0545	4.15	.164	20520	400 kcmil		37	2.64	.104	18.5	.728	400 kcmil
		1	3.67	.1443	3.67	.144	20520			240	37	2.9	.114	20.3	.798
6		7	1.55	.0612	4.66	.184	26240			61	2.26	.089	20.3	.801	473.6 kcmil
		1	4.11	.162	4.11	.162	26240			500 kcmil	37	2.95	.1162	20.7	.813
	16	7	1.73	.008	5.13	.204	31580		61	2.3	.0905	20.7	.814	500 kcmil	
5		7	1.75	.0688	5.24	.206	33090		300	61	2.51	.099	22.6	.891	592.1 kcmil
4		7	1.96	.0772	5.88	.232	41740	600 kcmil		61	2.52	.0992	22.7	.893	600 kcmil
	25	7	2.16	.085	6.48	.255	49340	700 kcmil		61	2.72	.1071	24.5	.964	700 kcmil
		19	1.32	.052	6.6	.26	49340		750 kcmil	61	2.82	.1109	25.4	.998	750 kcmil
3		7	2.2	.0867	6.61	.26	52620		91	2.31	.0908	25.4	.998	750 kcmil	
2		7	2.47	.0974	7.42	.292	66300		400	61	2.9	.114	26.1	1.026	798.4 kcmil
	35	7	2.54	.1	7.62	.300	69070	800 kcmil		61	2.91	.1145	26.2	1.031	800 kcmil
		19	1.55	.001	7.75	.305	69070		91	2.38	.0938	26.2	1.032	800 kcmil	
1		19	1.5	.0064	8.43	.332	83690		500	61	3.25	.128	28.3	1.152	986.8 kcmil
	50	19	1.85	.073	9.27	.365	98680	1000 kcmil		91	2.66	.1048	29.3	1.153	1000 kcmil
1/0		19	1.59	.0745	9.46	.373	10500		625	91	2.97	.117	32.7	1.287	1233.7 kcmil
2/0	70	19	2.13	.0837	10.6	.419	133100								
		19	2.18	.086	10.9	.43	138100								
3/0		19	2.59	.094	11.9	.47	167800								
		36	1.71	.0673	12	.471	167800								



































This chart details the different conductors commonly used in the industry. For each size, either AWG or Metric, various stranding options are listed. Typically the higher stranding is used in applications requiring greater conductor flexibility.

AWG to Metric Wire Crosses	
AWG	Metric (mm ²)
26-22	0.1-0.5
22-18	0.5-1.0
16-14	1.5-2.5
12-10	4.0-6.0

System Overview

Equivalent Tables Decimal/Inches/Millimeters











Terminals

	1/64	.0156	0,396		17/64	.2656	6,746		33/64	.5156	13,100		49/64	.7656	19,446
	3/64	.0468	1,189		19/64	.2968	7,541		35/64	.5468	13,891		51/64	.7968	20,241
	5/64	.0781	1,984		21/64	.3281	8,337		37/64	.5781	14,684		53/64	.8281	21,034
	7/64	.1093	2,779		23/64	.3593	9,129		39/64	.6093	15,479		55/64	.8593	21,828
	9/64	.1406	3,571		25/64	.3906	9,921		41/64	.6406	16,271		57/64	.8906	22,620
	11/64	.1718	4,366		27/64	.4218	10,716		43/64	.6718	17,066		59/64	.9218	23,416
	13/64	.2031	5,159		29/64	.4531	11,509		45/64	.7031	17,859		61/64	.9531	24,208
	15/64	.2343	5,954		31/64	.4843	12,304		47/64	.7343	18,654		63/64	.9843	25,001
		.25	6,350		1/2	.5	12,700		3/4	.75	19,050		1	1.	25,400

Ferrules

Stud Size Chart (Inches)

Compression Connectors





										
Standard Stud Size	#2	#4	#5	#6	#8	#10	1/4"	5/16"	3/8"	7/16"
Stud Size Decimal Equivalent	.086"	.112"	.127"	.138"	.164"	.190"	.250"	.312"	.375"	.438"
Terminal Hole Diameter	.090"	.118"	.127"	.146"	.173"	.204"	.270"	.343"	.392** .406***	.456"
Stud Size Designation in PANDUIT® Part Number	2	4	5	6	8	10	14	56	38	76

Crimping Tools

Mechanical Connectors

Grounding Connectors

Support Products

					
Standard Stud Size	1/2"	5/8"	3/4"	7/8"	1"
Stud Size Decimal Equivalent	.500"	.625"	.750"	.875"	1.00"
Terminal Hole Diameter	.531"	.656"	.810"	.906"	1.031"
Stud Size Designation in PANDUIT® Part Number	12	58	34	78	1

*Terminal Stud.
**Power Connector Stud.

Technical Info

Index

PANDUIT® TERMINATION SOLUTIONS

• Type BPC Tool Chart Pages L38-L39

Part Number	Page Number	Part Number	Page Number	Part Number	Page Number
B		CB25-18-C	H21	CD-920-4/0	G25
B2M2S-D	K37	CB35-36-C	H21	CD-920-400	G25
B3M2S-TL	K37	CB70-14-C	H21	CD-920-500	G25
B4M2S-TL	K37	CB125-14-Q	H21	CD-920-500A	G25
BF1M-C	K37	CB175-38-Q	H21	CD-920-6	G25
BF2M-C	K37	CB225-56-Q	H21	CD-920-600	G25
BM1M-C	K37	CB300-38-Q	H21	CD-920-750	G25
BM2M-C	K37	CB400-38-3	H21	CD-920-8	G25
BM2S-C	K37	CB650-12-3	H21	CD-920-BG	G25
BM4S-C	K37	CBA70-14-C	H21	CD-920-C	G25
BPC1-X	F117	CBR1.5I-M	K38	CD-920-D3	G25
BPC1/0-X	F117	CBR1.5M-M	K38	CD-920-O	G25
BPC2-L	F117	CBR1M-M	K38	CD-920H-2	G25
BPC2/0-X	F117	CBR2HS-D	K38	CD-920H-6	G25
BPC250-X	F117	CBR2M-M	K38	CD-920H-8	G25
BPC3/0-X	F117	CBR2S-M	K38	CD-930-N	G25
BPC300-X	F117	CBR3I-M	K38	CD-930H-250	G25
BPC350-X	F117	CBR3S-M	K38	CD-940-1000	G26
BPC4-L	F117	CBR4I-M	K38	CD-940-1000A	G26
BPC4/0-X	F117	CBR4LH-TL	K38	CD-940-750	G26
BPC400-X	F117	CBR4S-M	K38	CD-940-750A	G26
BPC500-X	F117	CBR6LH-C	K38	CD-940-750X	G26
BPC6-L	F117	CC-720	G11	CD-940-800	G26
BPC600-6	F117	CD-2001-1	G16	CD-940-800A	G26
BPC750-6	F117	CD-2001-1/0	G16	CD-940-DA	G26
BS10-L	D5	CD-2001-2	G16	CD-940-N	G26
BS14-C	D5	CD-2001-2/0	G16	CD-940H-1000	G26
BS18-C	D5	CD-2001-250	G16	CD-940H-500	G26
BS22-C	D5	CD-2001-3/0	G16	CD-940H-750	G26
BSH10-E	D7	CD-2001-300	G16	CD125-14-Q	H20
BSH14-Q	D7	CD-2001-350	G16	CD225-56-Q	H20
BSH18-Q	D7	CD-2001-4	G16	CD300-38-3	H20
BSM1-C	D8	CD-2001-4/0	G16	CD35-36-Q	H20
BSM2-C	D8	CD-2001-400	G16	CD400-38-3	H20
BSM6-L	D8	CD-2001-500	G16	CD650-12-3	H20
BSMV1BX-C	D7	CD-2001-6	G16	CD70-14-Q	H20
BSMV2BX-C	D7	CD-2001-8	G16	CD9-10A	K24
BSMV6X-L	D7	CD-2001-BG	G16	CD9-10B	K24
BSN10-L	D5	CD-2001-C	G16	CD9-11A	K24
BSN14-C	D5	CD-2001-O	G16	CD9-11B	K24
BSN18-C	D5	CD-720-1	G12	CD9-12A	K24
BSN22-C	D5	CD-720-2	G12	CD9-13B	K24
BSN10-2K	K13	CD-720-3	G12	CD9-14A	K24
BSN14-3K	K13	CD-720-4	G12	CD9-15A	K24
BSN18-3K	K13	CD-720-5	G12	CD9-16A	K24
BSP14-3K	K13	CD-720-6	G12	CD9-17B	K24
BSP18-3K	K13	CD-720-7	G12	CD9-18B	K24
BSV10X-L	D5	CD-720PV8-2	G12	CD9-1A	K24
BSV14X-C	D5	CD-800-1	K23	CD9-1AD	K24
BSV18X-C	D5	CD-800-10	K23	CD9-1B	K24
BT1.5I-C	K37	CD-800-11	K23	CD9-2A	K24
BT1.5M-C	K37	CD-800-12	K23	CD9-2AD	K24
BT1M-C	K37	CD-800-13	K23	CD9-2B	K24
BT2I-C	K37	CD-800-14	K23	CD9-3B	K24
BT2LH-L	K37	CD-800-15	K23	CD9-4A	K24
BT2M-C	K37	CD-800-16	K23	CD9-4B	K24
BT2S-C	K37	CD-800-17	K23	CD9-5A	K24
BT3I-C	K37	CD-800-18	K23	CD9-5B	K24
BT3LH-L	K37	CD-800-2	K23	CD9-6B	K24
BT3S-C	K37	CD-800-3	K23	CD9-7A	K24
BT4I-C	K37	CD-800-4	K23	CD9-8B	K24
BT4LH-L	K37	CD-800-5	K23	CD9-9C	K24
BT4M-C	K37	CD-800-6	K23	CDM-2001-1	G16
BT4S-C	K37	CD-800-7	K23	CDM-2001-1/0	G16
BT6LH-L	K37	CD-800-8	K23	CDM-2001-2	G16
BT7LH-L	K37	CD-800-9	K23	CDM-2001-2/0	G16
BT8LH-L	K37	CD-920-1	G25	CDM-2001-3/0	G16
BT9LH-L	K37	CD-920-1/0	G25	CDM-920-1	G25
C		CD-920-2	G25	CDM-920-1/0	G25
C-2001	G32	CD-920-2/0	G25	CDM-920-2	G25
C-720	G11	CD-920-250	G25	CDM-920-2/0	G25
CA-800	K22	CD-920-3/0	G25	CDM-920-250	G25
CA-800EZ	K22	CD-920-300	G25	CDM-920-3/0	G25
CA9	K22	CD-920-350	G25	CDM-920-4/0	G25
		CD-920-4	G25	CG-920	G31

System Overview

Terminals

Disconnects

Splices

Ferrules

Compression Connectors

Crimping Tools

Mechanical Connectors

Grounding Connectors

Support Products

Technical Info

Index

PANDUIT[®] TERMINATION SOLUTIONS

- Type CTAP Tool Chart [Page L34](#)
- Type CTAPF Tool Chart Pages [L32-L33](#)

System
Overview

Part Number	Page Number
-------------	----------------

Part Number	Page Number
-------------	----------------

Part Number	Page Number
-------------	----------------

Terminals

CG-940	.G31
CG-980	.G31
CLRCVR1-1	.F109
CLRCVR2-1	.F109
CLRCVR3-1	.F109
CLRCVR5-1	.F109
CLRCVR6-1	.F109

CT-930	.G13
CT-930CH	.G20
CT-930LPC	.G23
CT-940CH	.G21
CT-980	.G27
CT-980CH	.G30
CT-980LPC	.G30

DM6-63M-L	.C16
DMNF1-285-C	.C15
DMNF1-285FIB-C	.C15
DMNF1-288-C	.C15
DMNF1-288FIB-C	.C15
DMNF1-488-C	.C15
DMNF1-488FIB-C	.C15

Disconnects

CMP-100-1	.H33, F118
CMP-200-1	.H33, F118
CO125-14-Q	.H22
CO225-56-Q	.H22
CO300-38-3	.H22
CO35-36-Q	.H22
CO400-38-3	.H22
CO650-12-3	.H22
CO70-14-Q	.H22

CT-ACADPT	.G17, G28
CT-BC25	.G32
CT-CHR25	.G32
CT-NLBC25	.G32
CTAP2-2-X	.F106
CTAP2-4-Q	.F106
CTAP2/0-2-X	.F106
CTAP2/0-2/0-X	.F106
CTAP4-4-L	.F106

DMNF1-63-C	.C15
DMNF1-63FIB-C	.C15
DMNF1-63FIM-C	.C16
DMNF1-63M-C	.C16
DMNF2-488-C	.C15
DMNF2-488FIB-C	.C15
DMNF2-63-C	.C15

Splices

CP-861	.K22
CP-862	.K22
CS125-14-Q	.H19
CS175-38-Q	.H19
CS225-56-Q	.H19
CS25-18-C	.H19
CS300-38-Q	.H19
CS35-36-C	.H19
CS400-38-3	.H19
CS650-12-3	.H19
CS70-14-C	.H19
CSA70-14-C	.H19

CTAP4-6-L	.F106
CTAP4-8-L	.F106
CTAP4/0-2-X	.F106
CTAP4/0-2/0-X	.F106
CTAP4/0-4/0-X	.F106
CTAPF1-12-C	.F105
CTAPF1/0-12-L	.F105
CTAPF10-16-C	.F105
CTAPF2-12-C	.F105
CTAPF2/0-12-Q	.F105
CTAPF3-12-C	.F105
CTAPF3/0-12-Q	.F105

DMNF2-63-FIB-C	.C15
DMNF2-63FIM-C	.C16
DMNF2-63M-C	.C16
DMNF6-63FI-L	.C15
DMNF6-63M-L	.C16
DMV1-63P-C	.C16
DMV2-63P-C	.C16
DMV6-63-L	.C15

Ferrules

CST101	.G32
CST114-157	.G32
CST115	.G32
CT-100	.G8
CT-1002	.G10
CT-1003	.G10
CT-1004	.G10
CT-1005	.G10
CT-1006	.G10
CT-1014	.G9
CT-1015	.G9
CT-1525	.G9
CT-1550	.G9
CT-1551	.G9
CT-1570	.G9

CTAPF4-12-C	.F105
CTAPF6-12-C	.F105
CTAPF8-12-C	.F105
CW-12-Q	.H33, F115
CW-14-L	.H33, F115
CW-38-L	.H33, F115
CW-56-L	.H33, F115
CW-58-Q	.H33, F115
CX125-14-Q	.H18
CX125-56T-Q	.H18
CX225-38T-Q	.H18
CX225-56-Q	.H18
CX35-36-C	.H18
CX35-36T-C	.H18
CX400-38-3	.H18
CX400-12T-3	.H18
CX70-14-C	.H18
CX70-14T-C	.H18

DNF10-250FI-L	.C6, C7
DNF10-250FIB-2K	.K17
DNF10-250FIB-L	.C6
DNF10-250FIMB-K	.K20
DNF10-250FIMB-L	.C6
DNF10-250M-2K	.K21
DNF10-250M-L	.C12
DNF10250FIBX-2K	.K17
DNF14-110-C	.C8
DNF14-111-C	.C8
DNF14-187-C	.C8

Compression
Connectors

CT-1003	.G10
CT-1004	.G10
CT-1005	.G10
CT-1006	.G10
CT-1014	.G9
CT-1015	.G9
CT-1525	.G9
CT-1550	.G9
CT-1551	.G9
CT-1570	.G9
CT-160	.G8
CT-1700	.G9
CT-1701	.G9
CT-200	.G8
CT-2001	.G14
CT-2002	.G15
CT-260	.G8

D-250A-C	.C11
D10-250-L	.C9
D10-250M-L	.C12
D14-145M-C	.C13
D14-187-C	.C9
D14-188-C	.C9
D14-188B-C	.C9
D14-250-C	.C9
D14-250B-C	.C9
D14-250MB-C	.C12
D18-145M-C	.C13
D18-187-C	.C9
D18-188-C	.C9
D18-188B-C	.C9
D18-250-C	.C9
D18-250B-C	.C9
D18-250MB-C	.C12
DC450-38-3	.H22
DC600-38-3	.H22
DC800-12-3	.H22
DM1-488-C	.C16
DM1-63-C	.C16
DM1-63M-C	.C16
DM2-488-C	.C16
DM2-63-C	.C16
DM2-63M-C	.C16
DM6-63-L	.C16

DNF14-187FIB-3K	.K17
DNF14-187FIB-C	.C6
DNF14-188-C	.C8
DNF14-188FIB-C	.C6
DNF14-188FIB-3K	.K17
DNF14-205FIB-3K	.K17
DNF14-205-C	.C8
DNF14-206FIB-3K	.K17
DNF14-205FIB-C	.C6
DNF14-206-C	.C8
DNF14-206FIB-C	.C6
DNF14-250-C	.C8
DNF14-250FI-C	.C7
DNF14-250FIB-3K	.K17
DNF14-250FIB-C	.C6

Crimping
Tools

CT-1570	.G9
CT-160	.G8
CT-1700	.G9
CT-1701	.G9
CT-200	.G8
CT-2001	.G14
CT-2002	.G15
CT-260	.G8
CT-2930	.G18
CT-2931	.G17
CT-2940	.G19
CT-2980	.G29
CT-2981	.G28
CT-300-1	.G9
CT-310	.G9
CT-400	.G10
CT-460	.G10
CT-500CH	.G11
CT-520CH	.G11
CT-550CH	.G11
CT-570CH	.G11
CT-600	.G11
CT-720	.G11
CT-720-3	.G12
CT-720-3CC	.G12
CT-720-7	.G12
CT-720-7CC	.G12
CT-8250HP	.G24
CT-900HPH	.G22
CT-900LPHPH	.G24
CT-901HP	.G22
CT-901RCH	.G22
CT-901RFS	.G22, G24

DM6-63-L	.C16
DMNF1-285-C	.C15
DMNF1-285FIB-C	.C15
DMNF1-288-C	.C15
DMNF1-288FIB-C	.C15
DMNF1-488-C	.C15
DMNF1-488FIB-C	.C15
DMNF1-63-C	.C15
DMNF1-63FIB-C	.C15
DMNF1-63FIM-C	.C16
DMNF1-63M-C	.C16
DMNF2-488-C	.C15
DMNF2-488FIB-C	.C15
DMNF2-63-C	.C15
DMNF2-63FIB-C	.C15
DMNF2-63FIM-C	.C16
DMNF2-63M-C	.C16
DMNF6-63FI-L	.C15
DMNF6-63M-L	.C16
DMV1-63P-C	.C16
DMV2-63P-C	.C16
DMV6-63-L	.C15
DNF10-250FI-L	.C6, C7
DNF10-250FIB-2K	.K17
DNF10-250FIB-L	.C6
DNF10-250FIMB-K	.K20
DNF10-250FIMB-L	.C6
DNF10-250M-2K	.K21
DNF10-250M-L	.C12
DNF10250FIBX-2K	.K17
DNF14-110-C	.C8
DNF14-111-C	.C8
DNF14-187-C	.C8
DNF14-187FIB-3K	.K17
DNF14-187FIB-C	.C6
DNF14-188-C	.C8
DNF14-188FIB-C	.C6
DNF14-188FIB-3K	.K17
DNF14-205FIB-3K	.K17
DNF14-205-C	.C8
DNF14-206FIB-3K	.K17
DNF14-205FIB-C	.C6
DNF14-206-C	.C8
DNF14-206FIB-C	.C6
DNF14-250-C	.C8
DNF14-250FI-C	.C7
DNF14-250FIB-3K	.K17
DNF14-250FIB-C	.C6
DNF14-250FIM-2K	.K20
DNF14-250FIM-C	.C6
DNF14-250FIMB-K	.K20
DNF14-250FIMB-L	.C6
DNF14-250M-3K	.K21
DNF14-250M-C	.C12
DNF14205FIBX-2K	.K17
DNF14206FIBX-2K	.K17
DNF14250FIBX-2K	.K17
DNF14250FIMX-2K	.K20
DNF18-110-C	.C8
DNF18-110FIB-3K	.K17
DNF18-110FIB-C	.C6
DNF18-111-C	.C8
DNF18-111FIB-C	.C6
DNF18-111FIB-3K	.K17
DNF18-112FIB-3K	.K17
DNF18-187-C	.C8
DNF18-187FIB-3K	.K17
DNF18-187FIB-C	.C6
DNF18-188-C	.C8
DNF18-188FIB-3K	.K17
DNF18-188FIB-C	.C6
DNF18-205-C	.C8
DNF18-205FIB-3K	.K17
DNF18-205FIB-C	.C6

Mechanical
Connectors

CT-2001	.G14
CT-2002	.G15
CT-260	.G8
CT-2930	.G18
CT-2931	.G17
CT-2940	.G19
CT-2980	.G29
CT-2981	.G28
CT-300-1	.G9
CT-310	.G9
CT-400	.G10
CT-460	.G10
CT-500CH	.G11
CT-520CH	.G11
CT-550CH	.G11
CT-570CH	.G11
CT-600	.G11
CT-720	.G11
CT-720-3	.G12
CT-720-3CC	.G12
CT-720-7	.G12
CT-720-7CC	.G12
CT-8250HP	.G24
CT-900HPH	.G22
CT-900LPHPH	.G24
CT-901HP	.G22
CT-901RCH	.G22
CT-901RFS	.G22, G24

D

DM6-63-L	.C16
DMNF1-285-C	.C15
DMNF1-285FIB-C	.C15
DMNF1-288-C	.C15
DMNF1-288FIB-C	.C15
DMNF1-488-C	.C15
DMNF1-488FIB-C	.C15
DMNF1-63-C	.C15
DMNF1-63FIB-C	.C15
DMNF1-63FIM-C	.C16
DMNF1-63M-C	.C16
DMNF2-488-C	.C15
DMNF2-488FIB-C	.C15
DMNF2-63-C	.C15
DMNF2-63FIB-C	.C15
DMNF2-63FIM-C	.C16
DMNF2-63M-C	.C16
DMNF6-63FI-L	.C15
DMNF6-63M-L	.C16
DMV1-63P-C	.C16
DMV2-63P-C	.C16
DMV6-63-L	.C15
DNF10-250FI-L	.C6, C7
DNF10-250FIB-2K	.K17
DNF10-250FIB-L	.C6
DNF10-250FIMB-K	.K20
DNF10-250FIMB-L	.C6
DNF10-250M-2K	.K21
DNF10-250M-L	.C12
DNF10250FIBX-2K	.K17
DNF14-110-C	.C8
DNF14-111-C	.C8
DNF14-187-C	.C8
DNF14-187FIB-3K	.K17
DNF14-187FIB-C	.C6
DNF14-188-C	.C8
DNF14-188FIB-C	.C6
DNF14-188FIB-3K	.K17
DNF14-205FIB-3K	.K17
DNF14-205-C	.C8
DNF14-206FIB-3K	.K17
DNF14-205FIB-C	.C6
DNF14-206-C	.C8
DNF14-206FIB-C	.C6
DNF14-250-C	.C8
DNF14-250FI-C	.C7
DNF14-250FIB-3K	.K17
DNF14-250FIB-C	.C6
DNF14-250FIM-2K	.K20
DNF14-250FIM-C	.C6
DNF14-250FIMB-K	.K20
DNF14-250FIMB-L	.C6
DNF14-250M-3K	.K21
DNF14-250M-C	.C12
DNF14205FIBX-2K	.K17
DNF14206FIBX-2K	.K17
DNF14250FIBX-2K	.K17
DNF14250FIMX-2K	.K20
DNF18-110-C	.C8
DNF18-110FIB-3K	.K17
DNF18-110FIB-C	.C6
DNF18-111-C	.C8
DNF18-111FIB-C	.C6
DNF18-111FIB-3K	.K17
DNF18-112FIB-3K	.K17
DNF18-187-C	.C8
DNF18-187FIB-3K	.K17
DNF18-187FIB-C	.C6
DNF18-188-C	.C8
DNF18-188FIB-3K	.K17
DNF18-188FIB-C	.C6
DNF18-205-C	.C8
DNF18-205FIB-3K	.K17
DNF18-205FIB-C	.C6

Grounding
Connectors

CT-2001	.G14
CT-2002	.G15
CT-260	.G8
CT-2930	.G18
CT-2931	.G17
CT-2940	.G19
CT-2980	.G29
CT-2981	.G28
CT-300-1	.G9
CT-310	.G9
CT-400	.G10
CT-460	.G10
CT-500CH	.G11
CT-520CH	.G11
CT-550CH	.G11
CT-570CH	.G11
CT-600	.G11
CT-720	.G11
CT-720-3	.G12
CT-720-3CC	.G12
CT-720-7	.G12
CT-720-7CC	.G12
CT-8250HP	.G24
CT-900HPH	.G22
CT-900LPHPH	.G24
CT-901HP	.G22
CT-901RCH	.G22
CT-901RFS	.G22, G24

Support
Products

CT-400	.G10
CT-460	.G10
CT-500CH	.G11
CT-520CH	.G11
CT-550CH	.G11
CT-570CH	.G11
CT-600	.G11
CT-720	.G11
CT-720-3	.G12
CT-720-3CC	.G12
CT-720-7	.G12
CT-720-7CC	.G12
CT-8250HP	.G24
CT-900HPH	.G22
CT-900LPHPH	.G24
CT-901HP	.G22
CT-901RCH	.G22

PANDUIT® TERMINATION SOLUTIONS

Part Number	Page Number
-------------	-------------

DNF18-206-C	.C8
DNF18-206FIB-3K	.K17
DNF18-206FIB-C	.C6
DNF18-250-C	.C8
DNF18-250FI-C	.C7
DNF18-250FIB-3K	.K17
DNF18-250FIB-C	.C6
DNF18-250FIM-2K	.K20
DNF18-250FIM-C	.C6
DNF18-250FIMB-K	.K20
DNF18-250FIMB-L	.C6
DNF18-250M-3K	.K21
DNF18-250M-C	.C12
DNF18205FIBX-2K	.K17
DNF18206FIBX-2K	.K17
DNF18250FIBX-2K	.K17
DNF18250FIMX-2K	.K20
DNFR14-205B-C	.C10
DNFR14-205FIB-C	.C10
DNFR14-206B-C	.C10
DNFR14-206FIB-C	.C10
DNFR14-250B-C	.C10
DNFR14-250FIB-C	.C10
DNFR14205FIB-KD	.K18
DNFR14206FIB-KD	.K18
DNFR14250FIB-KD	.K18
DNFR18-205B-C	.C10
DNFR18-205FIB-C	.C10
DNFR18-206B-C	.C10
DNFR18-206FIB-C	.C10
DNFR18-250B-C	.C10
DNFR18-250FIB-C	.C10
DNFR18205FIB-KD	.K18
DNFR18206FIB-KD	.K18
DNFR18250FIB-KD	.K18
DNG14-187FB-3K	.K16
DNG14-187FB-C	.C5
DNG14-188FB-3K	.K16
DNG14-188FB-C	.C5
DNG14-250FB-3K	.K16
DNG14-250FB-C	.C5
DNG14-250FL-3K	.K16
DNG14-250FL-C	.C5
DNG18-187FB-3K	.K16
DNG18-187FB-C	.C5
DNG18-188FB-3K	.K16
DNG18-188FB-C	.C5
DNG18-250FB-3K	.K16
DNG18-250FB-C	.C5
DNG18-250FL-3K	.K16
DNG18-250FI-C	.C5
DNH10-250FI-E	.C13
DNH14-250FI-Q	.C13
DNH14-250FIM-Q	.C13
DNH18-250FIB-Q	.C13
DNH18-250FIM-Q	.C13
DPF10-250FI-L	.C7
DPF10-250FIB-2K	.K19
DPF10-250FIB-L	.C7
DPF14-187FIB-3K	.K19
DPF14-205FIB-3K	.K19
DPF14-205FIB-C	.C7
DPF14-206FIB-3K	.K19
DPF14-206FIB-C	.C7
DPF14-250FIB-3K	.K19
DPF14-250FIM-C	.C7
DPF14-250FIM-2K	.K19
DPF11-250FIM-C	.C7
DPF14-250FIMB-K	.K19
DPF14-250FIMB-L	.C7
DPF18-110FIB-3K	.K19
DPF18-110FIB-C	.C7
DPF18-111FIB-3K	.K19
DPF18-111FIB-C	.C7
DPF18-187FIB-3K	.K19

Part Number	Page Number
-------------	-------------

DPF18-188FIB-3K	.K19
DPF18-205FIB-3K	.K19
DPF18-205FIB-C	.C7
DPF18-206FIB-3K	.K19
DPF18-206FIB-C	.C7
DPF18-250FIB-3K	.K19
DPF18-250FIB-C	.C7
DPF18-250FIM-2K	.K19
DPF18-250FIM-C	.C7
DPF18-250FIMB-K	.K19
DPF18-250FIMB-L	.C7
DR10-250-L	.C10
DR14-205-C	.C10
DR14-205B-C	.C11
DR14-206-C	.C10
DR14-206B-C	.C11
DR14-250-C	.C10
DR14-250B-C	.C11
DR18-205-C	.C10
DR18-205B-C	.C11
DR18-206-C	.C10
DR18-206B-C	.C11
DR18-250-C	.C10
DR18-250B-C	.C11
DSF-NP	.K22
DSF-RS	.K22
DT4EH-L0	.K38
DT8EH-Q0	.K38
DTHEH-Q0	.K38
DTKEH-0	.K38
DTREH-LR0	.K38
DV10-250-2K	.K18
DV10-250-L	.C8
DV10-250C-2K	.K18
DV10-250M-2K	.K21
DV10-250M-L	.C12
DV14-145MB-3K	.K13
DV14-145M-C	.C13
DV14-187B-3K	.K18
DV14-187B-C	.C8
DV14-188B-3K	.K18
DV14-188B-C	.C8
DV14-205B-3K	.K18
DV14-205B-C	.C8
DV14-206B-3K	.K18
DV14-206B-C	.C8
DV14-250B-C	.C8
DV14-250B-3K	.K18
DV14-250B-C	.C8
DV14-250MB-3K	.K21
DV14-250MB-C	.C12
DV14-250P-C	.C11
DV18-145M-C	.C13
DV18-145MB-3K	.K13
DV18-187B-3K	.K18
DV18-187B-C	.C8
DV18-188B-3K	.K18
DV18-188B-C	.C8
DV18-205B-3K	.K18
DV18-205B-C	.C8
DV18-206B-3K	.K18
DV18-206B-C	.C8
DV18-250B-C	.C8
DV18-250B-3K	.K18
DV18-250MB-3K	.K21
DV18-250MB-C	.C12
DV18-250P-C	.C11
DVF14-187-C	.C8
DVF14-188-C	.C8
DVF14-205-C	.C8
DVF14-206-C	.C8
DVF14-250-C	.C8
DVF18-187-C	.C8
DVF18-188-C	.C8
DVF18-205-C	.C8

Part Number	Page Number
-------------	-------------

DVF18-206-C	.C8
DVF18-250-C	.C8
F	
F73-5-M	.E6
F73-7-M	.E6
F74-5-M	.E6
F74-7-M	.E6
F75-10-M	.E6
F75-6-M	.E6
F75-8-M	.E6
F76-10-M	.E6
F76-12-M	.E6
F76-6-M	.E6
F76-8-M	.E6
F77-10-M	.E6
F77-12-M	.E6
F77-6-M	.E6
F77-7-M	.E6
F77-8-M	.E6
F78-10-M	.E7
F78-12-M	.E7
F78-15-M	.E7
F78-18-M	.E7
F78-20-M	.E7
F78-7-M	.E7
F78-8-M	.E7
F80-10-M	.E7
F80-12-M	.E7
F80-15-M	.E7
F80-18-M	.E7
F80-20-M	.E7
F80-7-M	.E7
F80-8-M	.E7
F81-10-M	.E7
F81-12-M	.E7
F81-15-M	.E7
F81-18-M	.E7
F81-20-M	.E7
F81-9-M	.E7
F82-10-M	.E7
F82-12-M	.E7
F82-15-M	.E7
F82-18-M	.E7
F82-20-M	.E7
F83-12-D	.E7
F83-15-D	.E7
F83-18-D	.E7
F83-20-D	.E7
F83-25-D	.E7
F84-12-TL	.E7
F84-15-TL	.E7
F84-18-TL	.E7
F84-20-TL	.E7
F84-25-TL	.E7
F84-32-TL	.E7
F85-12-C	.E7
F85-15-C	.E7
F85-18-C	.E7
F85-25-C	.E7
F85-32-C	.E7
F86-18-C	.E7
F86-20-C	.E7
F86-25-C	.E7
F86-32-C	.E7
F87-18-C	.E7
F87-22-C	.E7
F87-25-C	.E7
F87-32-C	.E7
FPC-600	.G11
FSD72-6-D	.E4
FSD72-8-D	.E4
FSD73-6-D	.E4
FSD73-8-D	.E4
FSD74-6-D	.E4
FSD74-8-D	.E4

System Overview

Terminals

Disconnects

Splices

Ferrules

Compression Connectors

Crimping Tools

Mechanical Connectors

Grounding Connectors

Support Products

Technical Info

Index

PANDUIT® TERMINATION SOLUTIONS

System Overview	Part Number	Page Number	Part Number	Page Number	Part Number	Page Number
Terminals	FSD75-10-D	.E4	FSF86-16-L	.E5	H100X034F1T	.K34
	FSD75-6-D	.E4	FSF86-18-L	.E5	H100X044F13	.K35
	FSD75-8-D	.E4	FSF86-25-L	.E5	H100X044F16	.K34
	FSD76-10-D	.E4	FSF87-20-L	.E5	H100X044F1T	.K34
	FSD76-12-D	.E4	FSF87-25-Q	.E5	H100X064F1T	.K34
	FSD76-6-D	.E4	FTD75-8-D	.E6	H100X084F13	.K35
	FSD76-8-D	.E4	FTD76-10-D	.E6	H100X084F16	.K34
	FSD77-10-D	.E4	FTD76-8-D	.E6	H100X084F1T	.K34
	FSD77-12-D	.E4	FTD77-10-D	.E6	H100X165F1T	.K34
	FSD77-6-D	.E4	FTD77-8-D	.E6	H150X025F1T	.K34
Disconnects	FSD77-8-D	.E4	FTD78-12-D	.E6	H150X034F1T	.K34
	FSD78-10-D	.E4	FTD78-8-D	.E6	H150X044F1T	.K34
	FSD78-12-D	.E4	FTD80-10-TL	.E6	H175X025F16	.K34
	FSD78-18-D	.E4	FTD80-13-TL	.E6	H175X034F16	.K34
	FSD78-6-D	.E4	FTD81-12-C	.E6	H175X044F16	.K34
	FSD78-8-D	.E4	FTD82-14-C	.E6	H175X084F16	.K34
	FSD79-8-D	.E4			H200X025F1T	.K34
	FSD80-12-D	.E4			H200X034F1T	.K34
	FSD80-18-D	.E4			H200X044F1T	.K34
	FSD80-8-D	.E4			H200X064F1T	.K34
Splices	FSD81-10-D	.E4			H200X084F1T	.K34
	FSD81-12-C	.E4			H200X165F1T	.K34
	FSD81-18-C	.E4			H2L13-2N-2	.H16
	FSD82-12-C	.E4			H2L21-2N-2	.H16
	FSD82-18-C	.E4			H2L30-2N-1	.H16
	FSD83-12-C	.E4			H2L4-2N-X	.H16
	FSD83-18-C	.E4			H2L8-2N-2	.H16
	FSD84-12-C	.E4			HC13-3	.H17
	FSD84-18-C	.E4			HC21-1	.H17
	FSD85-16-L	.E4			HC30-1	.H17
Ferrules	FSD85-18-L	.E4			HC4-3	.H17
	FSD85-22-L	.E4			HC50-1	.H17
	FSD86-16-L	.E4			HC8-3	.H17
	FSD86-18-L	.E4			HHL13-2N-5	.H15
	FSD86-25-L	.E4			HHL21-2N-5	.H15
	FSD87-20-L	.E4			HHL30-2N-1	.H15
	FSD87-25-Q	.E4			HHL8-2N-X	.H15
	FSF72-6-D	.E5			HL1-2-25-X	.H14
	FSF72-8-D	.E5			HL1-25-X	.H12
	FSF73-6-D	.E5			HL13-1-5	.H12
Compression Connectors	FSF73-8-D	.E5			HL13-2-5	.H14
	FSF74-6-D	.E5			HL13-2N-5	.H15
	FSF74-8-D	.E5			HL21-1-5	.H12
	FSF75-10-D	.E5			HL21-2-5	.H14
	FSF75-6-D	.E5			HL21-2N-5	.H15
	FSF75-8-D	.E5			HL30-1-2	.H12
	FSF76-10-D	.E5			HL30-2-2	.H14
	FSF76-12-D	.E5			HL30-2N-2	.H15
	FSF76-6-D	.E5			HL4-1-X	.H12
	FSF76-8-D	.E5			HL4-2-X	.H14
Crimping Tools	FSF77-10-D	.E5			HL50-1-2	.H12
	FSF77-12-D	.E5			HL50-2-2	.H14
	FSF77-6-D	.E5			HL8-1-X	.H12
	FSF77-8-D	.E5			HL8-2-X	.H14
	FSF78-10-D	.E5			HL8-2N-X	.H15
	FSF78-12-D	.E5			HLA13-1-90-5	.H13
	FSF78-18-D	.E5			HLA21-1-90-5	.H13
	FSF78-6-D	.E5			HLA4-1-90-X	.H13
	FSF78-8-D	.E5			HLA8-1-90-X	.H13
	FSF79-8-D	.E5			HLB4-1-X	.H13
Mechanical Connectors	FSF80-12-D	.E5			HLM-15R0	.K39
	FSF80-18-D	.E5			HLS-15R0	.K39
	FSF80-8-D	.E5			HLS-75R0	.K39
	FSF81-10-D	.E5			HLS1.5S-X0	.K39
	FSF81-12-C	.E5			HLS3S-X0	.K39
	FSF81-18-C	.E5			HLS5S-X0	.K39
	FSF82-12-C	.E5			HLSP1.5S-X12	.K39
	FSF82-18-C	.E5			HLSP3S-X12	.K39
	FSF83-12-C	.E5			HLSP5S-X12	.K39
	FSF83-18-C	.E5			HLT2I-X0	.K39
Grounding Connectors	FSF84-12-C	.E5			HLT3I-X0	.K39
	FSF84-18-C	.E5			HLTP2I-X12	.K39
	FSF85-16-L	.E5			HLTP3I-X12	.K39
	FSF85-18-L	.E5			HSEC0.5-X	.K28
	FSF85-22-L	.E5			HSEC0.8-X	.K28
Support Products						
Technical Info						
Index						

PANDUIT® TERMINATION SOLUTIONS

• Type HTAP Tool Chart [Page L37](#)
 • Type HTCT Tool Chart [Page L35](#)

• Type LAA Tool Chart [Pages L40-L41](#)
 • Type LAB Tool Chart [Pages L40-L41](#)

Part Number	Page Number
HSEC1.0-X	K28
HSEC1.5-5	K28
HSEC2.0-5	K28
HSEC4.0-2	K28
HSECFR0.5-X	K28
HSECFR0.8-X	K28
HSECFR1.0-X	K28
HSECFR1.5-5	K28
HSECFR2.0-5	K28
HST0.4-3-Q	K27
HST0.4-48-5	K27
HST0.4-6-3	K27
HST0.4-6-X	K27
HST0.8-12-5	K27
HST0.8-48-5	K27
HST0.8-6-3	K27
HST0.8-6-X	K27
HST0.8-9-X	K27
HST1.1-12-5	K27
HST1.1-48-5	K27
HST1.1-6-3	K27
HST1.1-6-X	K27
HST1.1-9-2	K27
HST1.1-9-X	K27
HST1.5-12-1	K27
HST1.5-12-5	K27
HST1.5-48-5	K27
HST1.5-9-X	K27
HST2.0-12-2	K27
HST2.0-48-2	K27
HST2.0-9-5	K27
HST3.0-12-2	K27
HST3.0-48-2	K27
HSTT-YK1	K26
HSTT-YK1-45	K26
HSTT-YK2	K26
HSTT-YK2-45	K26
HSTT05-48-Q	K25
HSTT06-48-Q	K25
HSTT06-YK1	K26
HSTT09-48-Q	K25
HSTT09-YK1	K26
HSTT100-48-5	K25
HSTT100-YK1	K26
HSTT12-48-Q	K25
HSTT12-YK1	K26
HSTT150-48-5	K25
HSTT19-48-Q	K25
HSTT200-48-5	K25
HSTT25-48-Q	K25
HSTT25-YK1	K26
HSTT300-48-2	K25
HSTT38-48-Q	K25
HSTT38-YK1	K26
HSTT400-48-2	K25
HSTT50-48-Q	K25
HSTT50-YK1	K26
HSTT75-48-5	K25
HSTT75-YK1	K26
HSTTPN100-775-Q	K27
HSTTPN100-CC	K27
HSTTPN150-925-X	K27
HSTTPN150-CC	K27
HSTTPN200-950-X	K27
HSTTPN200-CC	K27
HSTTPN50-438-L	K27
HSTTPN50-713-Q	K27
HSTTPN50-CC	K27
HSTTPN62-750-Q	K27
HSTTPN62-CC	K27
HSTTPN75-775-Q	K27
HSTTPN75-CC	K27
HSTTV05-48-Q	K25
HSTTV06-48-Q	K25
HSTTV06-Y	K26

Part Number	Page Number
HSTTV09-48-Q	K25
HSTTV09-Y	K26
HSTTV100-48-5	K25
HSTTV100-Y	K26
HSTTV12-48-Q	K25
HSTTV12-Y	K26
HSTTV150-48-5	K25
HSTTV19-48-Q	K25
HSTTV19-Y	K26
HSTTV25-48-Q	K25
HSTTV25-Y	K26
HSTTV38-48-Q	K25
HSTTV38-Y	K26
HSTTV50-48-Q	K25
HSTTV50-Y	K26
HSTTV75-48-5	K25
HSTTV75-Y	K26
HTAP1-1-Q	F118
HTAP1/0-1-Q	F118
HTAP2-8-L	F118
HTAP2/0-1-Q	F118
HTAP3/0-1-Q	F118
HTAP3/0-3/0-Q	F118
HTAP4/0-2-Q	F118
HTAP4/0-3/0-Q	F118
HTAP4/0-4/0-Q	F118
HTAP500-4/0-X	F118
HTAP500-500-X	F118
HTCT1000-1000-1	F108
HTCT1000-250-1	F108
HTCT2-2-1	F108
HTCT250-2-1	F108
HTCT250-250-1	F108
HTCT250-8-1	F108
HTCT500-250-1	F108
HTCT500-500-1	F108
HTCT6-6-1	F108
HTCT750-4/0-1	F108
HTCT750-750-1	F108
HTCT8-8-1	F108
HTWC1000-1000-1	F107
HTWC1000-250-1	F107
HTWC2-2-1	F107
HTWC250-2-1	F107
HTWC250-250-1	F107
HTWC250-8-1	F107
HTWC500-250-1	F107
HTWC500-500-1	F107
HTWC6-6-1	F107
HTWC750-4/0-1	F107
HTWC750-750-1	F107
HTWC8-8-1	F107
I	
ILT1.5I-M	K39
ILT1M-M	K39
ILT2S-M	K39
ILT3S-M	K39
ILT4LH-TL	K39
ILT4S-M	K39
ILT6LH-C	K39
IPC500-250-2	H30
J	
J214-312-T	.D7
J216-410-L	.D7
J318-412-T	.D7
JMN2-C	.D8
JMN6-C	.D8
JN218-216-C	.D6
JN224-318-C	.D6
JN314-412-C	.D6
JN418-212-C	.D6
K	
K-1000	B30
K-1001	B30

Part Number	Page Number
K-1100	B30
K-1102	B30
K-1103	B30
K-1104	B30
K-205	B31
K1-PNKIT	B31
K2-PVKIT	B31
KH-1-L	J11
KH-2-L	J11
KLM14-250	H29
KLM350-800	H29
KLM6-250	H29
KLM6-600	H29
KLM6-800	H29
KLS-0-Q	J10
KLS-1-Q	J10
KLS-1A-X	J10
KP-1000	B30
KP-1075	B30
KP-1165	B30
KP-1166	B30
KP-F1	E8
KP-F2	E8
KP-FSD1	E8
KP-FSD2	E8
KP-FSD3	E8
KP1-C	J10
KP2-L	J10
L	
LAA1-14-X	F113
LAA1-38-X	F113
LAA1-56-X	F113
LAA1/0-12-X	F113
LAA1/0-38-X	F113
LAA1/0-56-X	F113
LAA1000-58-1	F113
LAA2-14-X	F113
LAA2-38-X	F113
LAA2-56-X	F113
LAA2/0-12-5	F113
LAA2/0-38-5	F113
LAA250-12-5	F133
LAA250-38-5	F113
LAA3/0-12-5	F113
LAA3/0-38-5	F113
LAA300-12-2	F113
LAA300-38-2	F113
LAA350-12-2	F113
LAA4-14-X	F113
LAA4-38-X	F113
LAA4-56-X	F113
LAA4/0-12-5	F113
LAA4/0-38-5	F113
LAA400-58-2	F113
LAA500-12-2	F113
LAA500-58-2	F113
LAA6-14-X	F113
LAA6-56-X	F113
LAA750-58-1	F113
LAB1/0-38-X	F114
LAB1000-12-1	F114
LAB2/0-12-5	F114
LAB250-12-5	F114
LAB3/0-12-5	F114
LAB300-12-2	F114
LAB350-12-2	F114
LAB4/0-12-5	F114
LAB400-12-2	F114
LAB500-12-2	F114
LAB600-12-2	F114
LAB750-12-1	F114
LAB800-12-1	F114
LAM2A1/0-14-6	H24
LAM2A1000-58-6	H24

System Overview

Terminals

Disconnects

Splices

Ferrules

Compression Connectors

Crimping Tools

Mechanical Connectors

Grounding Connectors

Support Products

Technical Info

Index

PANDUIT® TERMINATION SOLUTIONS

• Type LCA Tool Chart [Pages L8-L11](#)

System Overview	Part Number	Page Number	Part Number	Page Number	Part Number	Page Number
Terminals	LAM2A2/0-14-6	H24	LCA10-10-L	F12	LCA350-12-X	F13
	LAM2A250-38-6	H24	LCA10-14-L	F12	LCA350-12F-X	F17
	LAM2A350-12-6	H24	LCA10-14F-L	F16	LCA350-12H-X	F15
Disconnects	LAM2A600-12-6	H24	LCA10-14H-L	F14	LCA350-38-X	F13
	LAM2A800-58-6	H24	LCA10-38-L	F12	LCA350-38F-X	F17
	LAM2B350-12-3	H25	LCA10-56-L	F12	LCA350-38H-X	F15
	LAM2B600-12-3	H25	LCA2-00-Q	F20	LCA350-58-X	F13
	LAM2LB800-12-3	H25	LCA2-12-Q	F12	LCA350-58F-X	F17
	LAM2SA300-56-3	H24	LCA2-12F-Q	F16	LCA350-58H-X	F15
	LAM2SB600-38-1	H25	LCA2-12H-Q	F14	LCA350-78-X	F13
	LAM2SB750-38-1	H25	LCA2-14-Q	F12	LCA350-78F-X	F17
	LAM2SSB500-14-1	H25	LCA2-14F-Q	F16	LCA350-78H-X	F15
	LAM3B1/0-38-6	H26	LCA2-14H-Q	F14	LCA4-00-L	F20
Splices	LAM3B2-14-6	H26	LCA2-38-Q	F12	LCA4-10-L	F12
	LAM3B250-12-1	H26	LCA2-38F-Q	F16	LCA4-10F-L	F16
	LAM3B3/0-12-3	H26	LCA2-38H-Q	F14	LCA4-10H-L	F14
	LAM3B350-12-1	H26	LCA2-56-Q	F12	LCA4-14-L	F12
	LAM3B600-12-1	H26	LCA2-56F-Q	F16	LCA4-14F-L	F16
	LAM3D250-12-1	H27	LCA2-56H-Q	F14	LCA4-14H-L	F14
	LAM3D3/0-12-3	H27	LCA2/0-00-X	F20	LCA4-38-L	F12
	LAM3D350-12-1	H27	LCA2/0-12-X	F13	LCA4-38F-L	F16
	LAM3D600-12-1	H27	LCA2/0-12F-X	F16	LCA4-38H-L	F14
	LAM3LB1000-12-1	H26	LCA2/0-12H-X	F15	LCA4-56-L	F12
Ferrules	LAM3LB800-12-1	H26	LCA2/0-14-X	F13	LCA4-56F-L	F16
	LAM3LD1000-12-1	H27	LCA2/0-14F-X	F16	LCA4-56H-L	F14
	LAM3LD800-12-1	H27	LCA2/0-14H-X	F15	LCA4/0-00-X	F20
	LAM3SB600-38-1	H26	LCA2/0-34H-X	F15	LCA4/0-12-X	F13
	LAM3SB750-38-1	H26	LCA2/0-38-X	F13	LCA4/0-12F-X	F17
	LAM4D250-12-1	H28	LCA2/0-38F-X	F16	LCA4/0-12H-X	F15
	LAM4D350-12-1	H28	LCA2/0-38H-X	F15	LCA4/0-14-X	F13
	LAM4D600-12-1	H28	LCA2/0-56-X	F13	LCA4/0-14F-X	F17
	LAM4LD800-12-1	H28	LCA2/0-56F-X	F16	LCA4/0-14H-X	F15
	LAM4SB600-38-1	H27	LCA2/0-56H-X	F15	LCA4/0-38-X	F13
Compression Connectors	LAM4SB750-38-1	H27	LCA250-12-X	F13	LCA4/0-38F-X	F17
	LAMA1/0-14-Q	H23	LCA250-12F-X	F17	LCA4/0-38H-X	F15
	LAMA1000-58-6	H23	LCA250-12H-X	F15	LCA4/0-56-X	F13
	LAMA2-14-Q	H23	LCA250-14-X	F13	LCA4/0-56F-X	F17
	LAMA2/0-14-Q	H23	LCA250-14F-X	F17	LCA4/0-56H-X	F15
	LAMA250-56-Q	H23	LCA250-14H-X	F15	LCA400-00-6	F20
	LAMA300-56-Q	H23	LCA250-38-X	F13	LCA400-12-6	F13
	LAMA350-38-Q	H23	LCA250-38F-X	F17	LCA400-12F-6	F17
	LAMA500-38-6	H23	LCA250-38H-X	F15	LCA400-12H-6	F15
	LAMA6-14-Q	H23	LCA250-56-X	F13	LCA400-38-6	F13
Mechanical Connectors	LAMA600-38-6	H23	LCA250-56F-X	F17	LCA400-38F-6	F17
	LAMA600S-38-6	H23	LCA250-56H-X	F15	LCA400-38H-6	F15
	LAMA800-58-6	H23	LCA3/0-00-X	F20	LCA400-58-6	F13
	LAMB350-12-6	H23	LCA3/0-12-X	F13	LCA400-58F-6	F17
	LAMB600-12-3	H23	LCA3/0-12F-X	F17	LCA400-58H-6	F15
	LAMLB800-12-3	H23	LCA3/0-12H-X	F15	LCA400-78-6	F13
	LCA1-00-E	F20	LCA3/0-14-X	F13	LCA400-78F-6	F17
	LCA1-12-E	F12	LCA3/0-14F-X	F17	LCA400-78H-6	F15
	LCA1-12F-E	F16	LCA3/0-14H-X	F15	LCA500-00-6	F20
	LCA1-12H-E	F14	LCA3/0-38-X	F13	LCA500-1-6	F13
Support Products	LCA1-14-E	F12	LCA3/0-38F-X	F17	LCA500-12-6	F13
	LCA1-14F-E	F16	LCA3/0-38H-X	F15	LCA500-12F-6	F17
	LCA1-14H-E	F14	LCA3/0-56-X	F13	LCA500-12H-6	F15
	LCA1-38-E	F12	LCA3/0-56F-X	F17	LCA500-1F-6	F17
	LCA1-38F-E	F16	LCA3/0-56H-X	F15	LCA500-1H-6	F15
	LCA1-38H-E	F14	LCA300-00-X	F20	LCA500-34-6	F13
	LCA1-56-E	F12	LCA300-12-X	F13	LCA500-34F-6	F17
	LCA1-56F-E	F16	LCA300-12F-X	F17	LCA500-34H-6	F15
	LCA1-56H-E	F14	LCA300-12H-X	F15	LCA500-38-6	F13
	LCA1/0-00-X	F20	LCA300-38-X	F13	LCA500-38F-6	F17
Technical Info	LCA1/0-12-X	F13	LCA300-38F-X	F17	LCA500-38H-6	F15
	LCA1/0-12F-X	F16	LCA300-38H-X	F15	LCA500-58-6	F13
	LCA1/0-12H-X	F15	LCA300-56-X	F13	LCA500-58F-6	F17
	LCA1/0-14-X	F13	LCA300-56F-X	F17	LCA500-58H-6	F15
	LCA1/0-14F-X	F16	LCA300-56H-X	F15	LCA500-78-6	F13
	LCA1/0-14H-X	F15	LCA300-58-X	F13	LCA500-78F-6	F17
	LCA1/0-38-X	F13	LCA300-58F-X	F17	LCA500-78H-6	F15
	LCA1/0-38F-X	F16	LCA300-58H-X	F15	LCA6-00-L	F20
	LCA1/0-38H-X	F15	LCA300-78-X	F13	LCA6-10-L	F12
	LCA1/0-56-X	F13	LCA300-78F-X	F17	LCA6-10F-L	F16
Index	LCA1/0-56F-X	F16	LCA300-78H-X	F15	LCA6-10H-L	F14
	LCA1/0-56H-X	F15	LCA350-00-X	F20	LCA6-14-L	F12

PANDUIT® TERMINATION SOLUTIONS

• Type LCA Tool Chart [Pages L8-L11](#)
 • Type LCAF Tool Chart [Pages L24-L25](#)

• Type LCAN Tool Chart [Pages L8-L11](#)

Part Number	Page Number
LCA6-14F-L	F16
LCA6-14H-L	F14
LCA6-38-L	F12
LCA6-38F-L	F16
LCA6-38H-L	F14
LCA6-56-L	F12
LCA6-56F-L	F16
LCA6-56H-L	F14
LCA600-00-6	F20
LCA600-12-6	F13
LCA600-12F-6	F17
LCA600-12H-6	F15
LCA600-58-6	F13
LCA600-58F-6	F17
LCA600-58H-6	F15
LCA600-78-6	F13
LCA600-78F-6	F17
LCA600-78H-6	F15
LCA750-58-6	F13
LCA8-00-L	F20
LCA8-10-L	F12
LCA8-10F-L	F16
LCA8-10H-L	F14
LCA8-14-L	F12
LCA8-14F-L	F16
LCA8-14H-L	F14
LCA8-38-L	F12
LCA8-38F-L	F16
LCA8-38H-L	F14
LCA8-56-L	F12
LCA8-56F-L	F16
LCA8-56H-L	F14
LCAF1-12-X	F73
LCAF1-12F-X	F77
LCAF1-12H-X	F75
LCAF1-14-X	F73
LCAF1-14F-X	F77
LCAF1-14H-X	F75
LCAF1-38-X	F73
LCAF1-38F-X	F77
LCAF1-38H-X	F75
LCAF1-56-X	F73
LCAF1-56F-X	F77
LCAF1-56H-X	F75
LCAF1/0-12-X	F73
LCAF1/0-12F-X	F77
LCAF1/0-12H-X	F75
LCAF1/0-14-X	F73
LCAF1/0-14F-X	F77
LCAF1/0-14H-X	F75
LCAF1/0-38-X	F73
LCAF1/0-38F-X	F77
LCAF1/0-38H-X	F75
LCAF1/0-56-X	F73
LCAF1/0-56F-X	F77
LCAF1/0-56H-X	F75
LCAF2-12-E	F73
LCAF2-12F-E	F77
LCAF2-12H-E	F75
LCAF2-14-E	F73
LCAF2-14F-E	F77
LCAF2-14H-E	F75
LCAF2-38-E	F73
LCAF2-38F-E	F77
LCAF2-38H-E	F75
LCAF2-56-E	F73
LCAF2-56F-E	F77
LCAF2-56H-E	F75
LCAF2/0-12-X	F73
LCAF2/0-12F-X	F77
LCAF2/0-12H-X	F75
LCAF2/0-14-X	F73
LCAF2/0-14F-X	F77
LCAF2/0-14H-X	F75
LCAF2/0-38-X	F73

Part Number	Page Number
LCAF2/0-38F-X	F77
LCAF2/0-38H-X	F75
LCAF2/0-56-X	F73
LCAF2/0-56F-X	F77
LCAF2/0-56H-X	F75
LCAF250-12-X	F74
LCAF250-12F-X	F78
LCAF250-12H-X	F76
LCAF250-38-X	F74
LCAF250-38F-X	F78
LCAF250-38H-X	F76
LCAF250-58-X	F74
LCAF250-58F-X	F78
LCAF250-58H-X	F76
LCAF250-78-X	F74
LCAF250-78F-X	F78
LCAF250-78H-X	F76
LCAF3/0-12-X	F73
LCAF3/0-12F-X	F77
LCAF3/0-12H-X	F76
LCAF3/0-14-X	F73
LCAF3/0-14F-X	F77
LCAF3/0-14H-X	F76
LCAF3/0-38-X	F73
LCAF3/0-38F-X	F77
LCAF3/0-38H-X	F76
LCAF3/0-56-X	F73
LCAF3/0-56F-X	F77
LCAF3/0-56H-X	F76
LCAF300-12-6	F74
LCAF300-12F-6	F78
LCAF300-12H-6	F76
LCAF300-38-6	F74
LCAF300-38F-6	F78
LCAF300-38H-6	F76
LCAF300-58-6	F74
LCAF300-58F-6	F78
LCAF300-58H-6	F76
LCAF300-78-6	F74
LCAF300-78F-6	F78
LCAF300-78H-6	F76
LCAF350-1-6	F74
LCAF350-12-6	F74
LCAF350-12F-6	F78
LCAF350-12H-6	F76
LCAF350-1F-6	F78
LCAF350-1H-6	F76
LCAF350-34-6	F74
LCAF350-34F-6	F78
LCAF350-34H-6	F76
LCAF350-38-6	F74
LCAF350-38F-6	F78
LCAF350-38H-6	F76
LCAF350-58-6	F74
LCAF350-58F-6	F78
LCAF350-58H-6	F76
LCAF350-78-6	F74
LCAF350-78F-6	F78
LCAF350-78H-6	F76
LCAF4-10-L	F73
LCAF4-10F-L	F77
LCAF4-10H-L	F75
LCAF4-14-L	F73
LCAF4-14F-L	F77
LCAF4-14H-L	F75
LCAF4-38-L	F73
LCAF4-38F-L	F77
LCAF4-38H-L	F75
LCAF4-56-L	F73
LCAF4-56F-L	F77
LCAF4-56H-L	F75
LCAF4/0-12-X	F74
LCAF4/0-12F-X	F78
LCAF4/0-12H-X	F76
LCAF4/0-14-X	F74

Part Number	Page Number
LCAF4/0-14F-X	F78
LCAF4/0-14H-X	F76
LCAF4/0-38-X	F74
LCAF4/0-38F-X	F78
LCAF4/0-38H-X	F76
LCAF4/0-56-X	F74
LCAF4/0-56F-X	F78
LCAF4/0-56H-X	F76
LCAF400-12-6	F74
LCAF400-12F-6	F78
LCAF400-12H-6	F76
LCAF400-58-6	F74
LCAF400-58F-6	F78
LCAF400-58H-6	F76
LCAF400-78-6	F74
LCAF400-78F-6	F78
LCAF400-78H-6	F76
LCAF500-12-6	F74
LCAF500-58-6	F74
LCAF6-10-L	F73
LCAF6-10F-L	F77
LCAF6-10H-L	F75
LCAF6-14-L	F73
LCAF6-14F-L	F77
LCAF6-14H-L	F75
LCAF6-38-L	F73
LCAF6-38F-L	F77
LCAF6-38H-L	F75
LCAF6-56-L	F73
LCAF6-56F-L	F77
LCAF6-56H-L	F75
LCAF600-12-6	F74
LCAF600-58-6	F74
LCAF750-12-3	F74
LCAF750-58-3	F74
LCAF8-10-L	F73
LCAF8-10F-L	F77
LCAF8-10H-L	F75
LCAF8-14-L	F73
LCAF8-14F-L	F77
LCAF8-14H-L	F75
LCAF8-38-L	F73
LCAF8-38F-L	F77
LCAF8-38H-L	F75
LCAF8-56-L	F73
LCAF8-56F-L	F77
LCAF8-56H-L	F75
LCAN1-10-E	F18
LCAN1-14-E	F18
LCAN1/0-10-X	F18
LCAN1/0-14-X	F18
LCAN1/0-56-X	F18
LCAN1/0-56H-X	F18
LCAN2-10-Q	F18
LCAN2-14-Q	F18
LCAN2-56-Q	F18
LCAN2/0-10-X	F18
LCAN2/0-14-X	F18
LCAN2/0-38-X	F18
LCAN2/0-56-X	F18
LCAN250-14-X	F19
LCAN250-38-X	F19
LCAN3/0-14-X	F18
LCAN3/0-38-X	F18
LCAN3/0-56-X	F18
LCAN300-14-X	F19
LCAN300-38-X	F19
LCAN350-12-X	F19
LCAN350-38-X	F19
LCAN4-10-L	F18
LCAN4-14-L	F18
LCAN4/0-14-X	F18
LCAN4/0-38-X	F18
LCAN4/0-56-X	F18
LCAN400-12-6	F19
LCAN400-38-6	F19

System Overview

Terminals

Disconnects

Splices

Ferrules

Compression Connectors

Crimping Tools

Mechanical Connectors

Grounding Connectors

Support Products

Technical Info

Index

PANDUIT® TERMINATION SOLUTIONS

• Type LCAN Tool Chart [Pages L8-L11](#)
• Type LCAS Tool Chart [Pages L6-L7](#)

• Type LCAX Tool Chart [Pages L22-L23](#)

System Overview	Part Number	Page Number	Part Number	Page Number	Part Number	Page Number	
Terminals	LCAN500-12-6	F19	LCAS3/0-38-X	F7	LCAX1/0-38-X	F64	
	LCAN500-38-6	F19	LCAS3/0-38F-X	F11	LCAX1/0-38F-X	F68	
	LCAN6-6-L	F18	LCAS3/0-38H-X	F9	LCAX1/0-38H-X	F66	
	LCAN600-12-6	F19	LCAS3/0-56-X	F7	LCAX1/0-56-X	F64	
	LCAN600-38-6	F19	LCAS3/0-56F-X	F11	LCAX1/0-56F-X	F68	
	LCAN750-12-6	F19	LCAS3/0-56H-X	F9	LCAX1/0-56H-X	F66	
	LCAN750-38-6	F19	LCAS4-10-L	F6	LCAX2-10-E	F64	
	LCAN750-58-6	F19	LCAS4-10F-L	F10	LCAX2-10F-E	F68	
	LCAN8-6-L	F18	LCAS4-10H-L	F8	LCAX2-10H-E	F66	
	LCAS1-12-E	F6	LCAS4-14-L	F6	LCAX2-12-E	F64	
Disconnects	LCAS1-12F-E	F10	LCAS4-14F-L	F10	LCAX2-12F-E	F68	
	LCAS1-12H-E	F8	LCAS4-14H-L	F8	LCAX2-12H-E	F66	
	LCAS1-14-E	F6	LCAS4-38-L	F6	LCAX2-14-E	F64	
	LCAS1-14F-E	F10	LCAS4-38F-L	F10	LCAX2-14F-E	F68	
	LCAS1-14H-E	F8	LCAS4-38H-L	F8	LCAX2-14H-E	F66	
	LCAS1-38-E	F6	LCAS4-56-L	F6	LCAX2-38-E	F64	
	LCAS1-38F-E	F10	LCAS4-56F-L	F10	LCAX2-38F-E	F68	
	LCAS1-38H-E	F8	LCAS4-56H-L	F8	LCAX2-38H-E	F66	
	LCAS1-56-E	F6	LCAS4/0-12-X	F7	LCAX2-56-E	F64	
	LCAS1-56F-E	F10	LCAS4/0-12F-X	F11	LCAX2-56F-E	F68	
Splices	LCAS1-56H-E	F8	LCAS4/0-12H-X	F9	LCAX2-56H-E	F66	
	LCAS1/0-12-X	F6	LCAS4/0-14-X	F7	LCAX2/0-10-X	F64	
	LCAS1/0-12F-X	F10	LCAS4/0-14F-X	F11	LCAX2/0-10F-X	F68	
	LCAS1/0-12H-X	F8	LCAS4/0-14H-X	F9	LCAX2/0-10H-X	F66	
	LCAS1/0-14-X	F6	LCAS4/0-38-X	F7	LCAX2/0-12-X	F64	
	LCAS1/0-14F-X	F10	LCAS4/0-38F-X	F11	LCAX2/0-12F-X	F68	
	LCAS1/0-14H-X	F8	LCAS4/0-38H-X	F9	LCAX2/0-12H-X	F66	
	LCAS1/0-38-X	F6	LCAS4/0-56-X	F7	LCAX2/0-14-X	F64	
	LCAS1/0-38F-X	F10	LCAS4/0-56F-X	F11	LCAX2/0-14F-X	F68	
	LCAS1/0-38H-X	F8	LCAS4/0-56H-X	F9	LCAX2/0-14H-X	F66	
Ferrules	LCAS1/0-56-X	F6	LCAS6-10-L	F6	LCAX2/0-34-X	F64	
	LCAS1/0-56F-X	F10	LCAS6-10F-L	F10	LCAX2/0-34F-X	F68	
	LCAS1/0-56H-X	F8	LCAS6-10H-L	F8	LCAX2/0-34H-X	F66	
	LCAS2-12-Q	F6	LCAS6-14-L	F6	LCAX2/0-38-X	F64	
	LCAS2-12F-Q	F10	LCAS6-14F-L	F10	LCAX2/0-38F-X	F68	
	LCAS2-12H-Q	F8	LCAS6-14H-L	F8	LCAX2/0-38H-X	F66	
	LCAS2-14-Q	F6	LCAS6-38-L	F6	LCAX2/0-56-X	F64	
	LCAS2-14F-Q	F10	LCAS6-38F-L	F10	LCAX2/0-56F-X	F68	
	LCAS2-14H-Q	F8	LCAS6-38H-L	F8	LCAX2/0-56H-X	F66	
	LCAS2-38-Q	F6	LCAS6-56-L	F6	LCAX2/0-58-X	F64	
Compression Connectors	LCAS2-38F-Q	F10	LCAS6-56F-L	F10	LCAX2/0-58F-X	F68	
	LCAS2-38H-Q	F8	LCAS6-56H-L	F8	LCAX2/0-58H-X	F66	
	LCAS2-56-Q	F6	LCAS8-10-L	F6	LCAX250-12-X	F65	
	LCAS2-56F-Q	F10	LCAS8-10F-L	F10	LCAX250-12F-X	F69	
	LCAS2-56H-Q	F8	LCAS8-10H-L	F8	LCAX250-12H-X	F67	
	LCAS2/0-12-X	F7	LCAS8-14-L	F6	LCAX250-14-X	F65	
	LCAS2/0-12F-X	F11	LCAS8-14F-L	F10	LCAX250-14F-X	F69	
	LCAS2/0-12H-X	F9	LCAS8-14H-L	F8	LCAX250-14H-X	F67	
	LCAS2/0-14-X	F7	LCAS8-38-L	F6	LCAX250-34-X	F65	
	LCAS2/0-14F-X	F11	LCAS8-38F-L	F10	LCAX250-34F-X	F69	
Crimping Tools	LCAS2/0-14H-X	F9	LCAS8-38H-L	F8	LCAX250-34H-X	F67	
	LCAS2/0-38-X	F7	LCAS8-56-L	F6	LCAX250-38-X	F65	
	LCAS2/0-38F-X	F11	LCAS8-56F-L	F10	LCAX250-38F-X	F69	
	LCAS2/0-38H-X	F9	LCAS8-56H-L	F8	LCAX250-38H-X	F67	
	LCAS2/0-56-X	F7	LCAX1-10-X	F64	LCAX250-56-X	F65	
	LCAS2/0-56F-X	F11	LCAX1-10F-X	F68	LCAX250-56F-X	F69	
	LCAS2/0-56H-X	F9	LCAX1-10H-X	F66	LCAX250-56H-X	F67	
	LCAS250-12-X	F7	LCAX1-12-X	F64	LCAX250-58-X	F65	
	LCAS250-12F-X	F11	LCAX1-12F-X	F68	LCAX250-58F-X	F69	
	LCAS250-12H-X	F9	LCAX1-12H-X	F66	LCAX250-58H-X	F67	
Mechanical Connectors	LCAS250-14-X	F7	LCAX1-14-X	F64	LCAX3/0-10-X	F65	
	LCAS250-14F-X	F11	LCAX1-14F-X	F68	LCAX3/0-10F-X	F69	
	LCAS250-14H-X	F9	LCAX1-14H-X	F66	LCAX3/0-10H-X	F67	
	LCAS250-38-X	F7	LCAX1-38-X	F64	LCAX3/0-12-X	F65	
	LCAS250-38F-X	F11	LCAX1-38F-X	F68	LCAX3/0-12F-X	F69	
	LCAS250-38H-X	F9	LCAX1-38H-X	F66	LCAX3/0-12H-X	F67	
	LCAS250-56-X	F7	LCAX1-56-X	F64	LCAX3/0-14-X	F65	
	LCAS250-56F-X	F11	LCAX1-56F-X	F68	LCAX3/0-14F-X	F69	
	LCAS250-56H-X	F9	LCAX1-56H-X	F66	LCAX3/0-14H-X	F67	
	LCAS3/0-12-X	F7	LCAX1/0-12-X	F64	LCAX3/0-38-X	F65	
Grounding Connectors	LCAS3/0-12F-X	F11	LCAX1/0-12F-X	F68	LCAX3/0-38F-X	F69	
	LCAS3/0-12H-X	F9	LCAX1/0-12H-X	F66	LCAX3/0-38H-X	F67	
	LCAS3/0-14-X	F7	LCAX1/0-14-X	F64	LCAX3/0-56-X	F65	
	LCAS3/0-14F-X	F11	LCAX1/0-14F-X	F68	LCAX3/0-56F-X	F69	
	LCAS3/0-14H-X	F9	LCAX1/0-14H-X	F66	LCAX3/0-56H-X	F67	
	Support Products	LCAS3/0-14F-X	F11	LCAS3/0-12-X	F7	LCAX3/0-10-X	F65
		LCAS3/0-14H-X	F9	LCAS3/0-12F-X	F11	LCAX3/0-10F-X	F69
		LCAS3/0-14F-X	F11	LCAS3/0-12H-X	F9	LCAX3/0-10H-X	F67
		LCAS3/0-14H-X	F9	LCAS3/0-14-X	F7	LCAX3/0-12-X	F65
		LCAS3/0-14F-X	F11	LCAS3/0-14F-X	F11	LCAX3/0-12F-X	F69
LCAS3/0-14H-X		F9	LCAS3/0-14H-X	F9	LCAX3/0-12H-X	F67	
LCAS3/0-14F-X		F11	LCAS3/0-14F-X	F11	LCAX3/0-14-X	F65	
LCAS3/0-14H-X		F9	LCAS3/0-14H-X	F9	LCAX3/0-14F-X	F69	
LCAS3/0-14F-X		F11	LCAS3/0-14F-X	F11	LCAX3/0-14H-X	F67	
LCAS3/0-14H-X		F9	LCAS3/0-14H-X	F9	LCAX3/0-38-X	F65	
Technical Info	LCAS3/0-14F-X	F11	LCAS3/0-12F-X	F11	LCAX3/0-38F-X	F69	
	LCAS3/0-14H-X	F9	LCAS3/0-12H-X	F9	LCAX3/0-38H-X	F67	
	LCAS3/0-14-X	F7	LCAS3/0-14-X	F7	LCAX3/0-56-X	F65	
	LCAS3/0-14F-X	F11	LCAS3/0-14F-X	F11	LCAX3/0-56F-X	F69	
	LCAS3/0-14H-X	F9	LCAS3/0-14H-X	F9	LCAX3/0-56H-X	F67	
	Index	LCAS3/0-14F-X	F11	LCAS3/0-14F-X	F11	LCAX3/0-56F-X	F69
		LCAS3/0-14H-X	F9	LCAS3/0-14H-X	F9	LCAX3/0-56H-X	F67

PANDUIT® TERMINATION SOLUTIONS

• Type LCAX Tool Chart [Pages L22-L23](#)
 • Type LCAXN Tool Chart [Pages L22-L23](#)

• Type LCB Tool Chart [Pages L12-L15](#)

Part Number	Page Number
LCAX300-12-6	F65
LCAX300-12F-6	F69
LCAX300-12H-6	F67
LCAX300-38-6	F65
LCAX300-38F-6	F69
LCAX300-38H-6	F67
LCAX300-58-6	F65
LCAX300-58F-6	F69
LCAX300-58H-6	F67
LCAX350-12-6	F65
LCAX350-12F-6	F69
LCAX350-12H-6	F67
LCAX350-38-6	F65
LCAX350-38F-6	F69
LCAX350-38H-6	F67
LCAX350-56-6	F65
LCAX350-56F-6	F69
LCAX350-56H-6	F67
LCAX350-58-6	F65
LCAX350-58F-6	F69
LCAX350-58H-6	F67
LCAX4-10-L	F64
LCAX4-10F-L	F68
LCAX4-10H-L	F66
LCAX4-14-L	F64
LCAX4-14F-L	F68
LCAX4-14H-L	F66
LCAX4-38-L	F64
LCAX4-38F-L	F68
LCAX4-38H-L	F66
LCAX4-56-L	F64
LCAX4-56F-L	F68
LCAX4-56H-L	F66
LCAX4/0-12-X	F65
LCAX4/0-12F-X	F69
LCAX4/0-12H-X	F67
LCAX4/0-14-X	F65
LCAX4/0-14F-X	F69
LCAX4/0-14H-X	F67
LCAX4/0-34-X	F65
LCAX4/0-34F-X	F69
LCAX4/0-34H-X	F67
LCAX4/0-38-X	F65
LCAX4/0-38F-X	F69
LCAX4/0-38H-X	F67
LCAX4/0-56-X	F65
LCAX4/0-56F-X	F69
LCAX4/0-56H-X	F67
LCAX4/0-58-X	F65
LCAX4/0-58F-X	F69
LCAX4/0-58H-X	F67
LCAX450-12-6	F65
LCAX450-12F-6	F69
LCAX450-12H-6	F67
LCAX450-58-6	F65
LCAX450-58F-6	F69
LCAX450-58H-6	F67
LCAX500-12-6	F65
LCAX500-12F-6	F69
LCAX500-12H-6	F67
LCAX500-38-6	F65
LCAX500-38F-6	F69
LCAX500-38H-6	F67
LCAX500-56-6	F65
LCAX500-56F-6	F69
LCAX500-56H-6	F67
LCAX500-58-6	F65
LCAX500-58F-6	F69
LCAX500-58H-6	F67
LCAX6-10-L	F64
LCAX6-10F-L	F68
LCAX6-10H-L	F66
LCAX6-14-L	F64
LCAX6-14F-L	F68
LCAX6-14H-L	F66

Part Number	Page Number
LCAX6-38-L	F64
LCAX6-38F-L	F68
LCAX6-38H-L	F66
LCAX6-56-L	F64
LCAX6-56F-L	F68
LCAX6-56H-L	F66
LCAX650-12-6	F65
LCAX650-12F-6	F69
LCAX650-12H-6	F67
LCAX650-38-6	F65
LCAX650-38F-6	F69
LCAX650-38H-6	F67
LCAX650-56-6	F65
LCAX650-56F-6	F69
LCAX650-56H-6	F67
LCAX650-58-6	F65
LCAX650-58F-6	F69
LCAX650-58H-6	F67
LCAX750-12-3	F65
LCAX750-12F-3	F69
LCAX750-12H-3	F67
LCAX750-58-3	F65
LCAX750-58F-3	F69
LCAX750-58H-3	F67
LCAX8-10-L	F64
LCAX8-10F-L	F68
LCAX8-10H-L	F66
LCAX8-14-L	F64
LCAX8-14F-L	F68
LCAX8-14H-L	F66
LCAX8-38-L	F64
LCAX8-38F-L	F68
LCAX8-38H-L	F66
LCAX8-56-L	F64
LCAX8-56F-L	F68
LCAX8-56H-L	F66
LCAXN250-12-X	F70
LCAXN250-12F-X	F72
LCAXN250-12H-X	F71
LCB1-10-E	F21
LCB1-10F-E	F25
LCB1-10H-E	F23
LCB1-38-E	F21
LCB1-56-E	F21
LCB1-56F-E	F25
LCB1-56H-E	F23
LCB1/0-10-X	F21
LCB1/0-10F-X	F25
LCB1/0-10H-X	F23
LCB1/0-12-X	F21
LCB1/0-12F-X	F25
LCB1/0-12H-X	F23
LCB1/0-38-X	F21
LCB1/0-38F-X	F25
LCB1/0-38H-X	F23
LCB1/0-56-X	F21
LCB1/0-56F-X	F25
LCB1/0-56H-X	F23
LCB10-14W-L	F27
LCB10-14WF-L	F29
LCB10-14WH-L	F28
LCB1000-12W-3	F27
LCB1000-38W-3	F27
LCB1000-58-3	F22
LCB1000-58W-3	F27
LCB2-10-Q	F21
LCB2-10F-Q	F25
LCB2-10H-Q	F23
LCB2-38-Q	F21
LCB2-56-Q	F21
LCB2-56F-Q	F25
LCB2-56H-Q	F23
LCB2/0-12-X	F22
LCB2/0-12F-X	F25
LCB2/0-12H-X	F23

Part Number	Page Number
LCB2/0-38-X	F22
LCB2/0-38F-X	F25
LCB2/0-38H-X	F23
LCB250-12-X	F22
LCB250-12F-X	F26
LCB250-12H-X	F23
LCB250-78-X	F22
LCB250-78F-X	F26
LCB250-78H-X	F23
LCB3/0-12-X	F22
LCB3/0-12F-X	F25
LCB3/0-12H-X	F23
LCB3/0-38-X	F22
LCB3/0-38F-X	F25
LCB3/0-38H-X	F23
LCB300-12-X	F22
LCB300-12F-X	F26
LCB300-12H-X	F23
LCB300-38-X	F22
LCB300-38F-X	F26
LCB300-38H-X	F23
LCB300-56-X	F22
LCB300-56F-X	F26
LCB300-56H-X	F23
LCB350-12-X	F22
LCB350-12F-X	F26
LCB350-12H-X	F23
LCB350-78-X	F22
LCB350-78F-X	F26
LCB350-78H-X	F23
LCB4-10-L	F21
LCB4-10F-L	F25
LCB4-10H-L	F23
LCB4-14-L	F21
LCB4-14F-L	F25
LCB4-14H-L	F23
LCB4-38-L	F21
LCB4/0-12-X	F22
LCB4/0-12F-X	F25
LCB4/0-12H-X	F23
LCB4/0-38-X	F22
LCB4/0-38F-X	F25
LCB4/0-38H-X	F23
LCB400-12-6	F22
LCB400-12F-6	F26
LCB400-12H-6	F24
LCB400-38-6	F22
LCB400-58-6	F22
LCB400-58F-6	F26
LCB400-58H-6	F24
LCB400-78-6	F22
LCB400-78F-6	F26
LCB400-78H-6	F24
LCB500-12-6	F22
LCB500-12F-6	F26
LCB500-12H-6	F24
LCB500-58-6	F22
LCB500-58F-6	F26
LCB500-58H-6	F24
LCB500-78-6	F22
LCB500-78F-6	F26
LCB500-78H-6	F24
LCB6-10-L	F21
LCB6-10F-L	F25
LCB6-10H-L	F23
LCB6-14-L	F21
LCB6-14F-L	F25
LCB6-14H-L	F23
LCB6-38-L	F21
LCB6-38F-L	F25
LCB6-38H-L	F23
LCB600-12-6	F22
LCB600-12F-6	F26
LCB600-12H-6	F24
LCB600-58-6	F22

System Overview

Terminals

Disconnects

Splices

Ferrules

Compression Connectors

Crimping Tools

Mechanical Connectors

Grounding Connectors

Support Products

Technical Info

Index

PANDUIT® TERMINATION SOLUTIONS

• Type LCB Tool Chart [Pages L12-L15](#)
 • Type LCBH Tool Chart [Pages L16-L17](#)

• Type LCBX Tool Chart [Pages L22-L23](#)
 • Type LCC Tool Chart [Pages L12-L15](#)

System Overview	Part Number	Page Number	Part Number	Page Number	Part Number	Page Number
Terminals	LCB600-58F-6	F26	LCBX350-12H-6	F80	LCC1-56CW-E	F47
	LCB600-58H-6	F24	LCBX350-38-6	F79	LCC1-56CWF-E	F53
	LCB750-12W-6	F27	LCBX350-38F-6	F81	LCC1-56CWH-E	F50
	LCB750-38W-6	F27	LCBX350-38H-6	F80	LCC1/0-00-X	F56
	LCB750-58-6	F22	LCBX4-14-L	F79	LCC1/0-00W-X	F57
	LCB750-58W-6	F27	LCBX4-14F-L	F81	LCC1/0-12DF-X	F45
Disconnects	LCB750-78-6	F22	LCBX4-14H-L	F80	LCC1/0-12DH-X	F43
	LCB750-78W-6	F27	LCBX4-38-L	F79	LCC1/0-12DW-X	F47
	LCB8-10-L	F21	LCBX4-38F-L	F81	LCC1/0-12DWF-X	F53
	LCB8-10F-L	F25	LCBX4-38H-L	F80	LCC1/0-12DWH-X	F50
	LCB8-10H-L	F23	LCBX4/0-12-X	F79	LCC1/0-12F-X	F45
	LCB8-14-L	F21	LCBX4/0-12F-X	F81	LCC1/0-12H-X	F43
	LCB8-14F-L	F25	LCBX4/0-12H-X	F80	LCC1/0-12W-X	F47
	LCB8-14H-L	F23	LCBX4/0-38-X	F79	LCC1/0-12WF-X	F53
	LCB8-38-L	F21	LCBX4/0-38F-X	F81	LCC1/0-12WH-X	F50
	LCB800-12W-6	F27	LCBX4/0-38H-X	F80	LCC1/0-14A-X	F41
Splices	LCB800-58-6	F22	LCBX450-38-6	F79	LCC1/0-14AF-X	F45
	LCB800-58W-6	F27	LCBX450-38F-6	F81	LCC1/0-14AH-X	F43
	LCBH1-38-E	F30	LCBX450-38H-6	F80	LCC1/0-14AW-X	F47
	LCBH1/0-38-X	F30	LCBX500-12-6	F79	LCC1/0-14AWF-X	F53
	LCBH2-38-Q	F30	LCBX500-12F-6	F81	LCC1/0-14AWHF-X	F50
	LCBH2/0-12-X	F30	LCBX500-12H-6	F80	LCC1/0-14B-X	F41
	LCBH250-12-X	F30	LCBX500-38-6	F79	LCC1/0-14BF-X	F45
	LCBH3/0-12-X	F30	LCBX500-38F-6	F81	LCC1/0-14BH-X	F43
	LCBH4-38-L	F30	LCBX500-38H-6	F80	LCC1/0-14BW-X	F47
	LCBH4/0-12-X	F30	LCBX6-14-L	F79	LCC1/0-14BWF-X	F53
Ferrules	LCBX1-14-X	F79	LCBX6-14F-L	F81	LCC1/0-14BWH-X	F50
	LCBX1-14F-X	F81	LCBX6-14H-L	F80	LCC1/0-14DW-X	F47
	LCBX1-14H-X	F80	LCBX6-38-L	F79	LCC1/0-14DWF-X	F53
	LCBX1-38-X	F79	LCBX6-38F-L	F81	LCC1/0-14DWH-X	F50
	LCBX1-38F-X	F81	LCBX6-38H-L	F80	LCC1/0-38D-X	F41
	LCBX1-38H-X	F80	LCBX8-10-L	F79	LCC1/0-38DF-X	F45
	LCBX1-56-X	F79	LCBX8-10F-L	F81	LCC1/0-38DH-X	F43
	LCBX1-56F-X	F81	LCBX8-10H-L	F80	LCC1/0-38DW-X	F47
	LCBX1-56H-X	F80	LCBX8-14-L	F79	LCC1/0-38DWF-X	F53
	LCBX1/0-12-X	F79	LCBX8-14F-L	F81	LCC1/0-38DWH-X	F50
Crimping Tools	LCBX1/0-12F-X	F81	LCBX8-14H-L	F80	LCC1/0-38W-X	F47
	LCBX1/0-12H-X	F80	LCBX8-38-L	F79	LCC1/0-38WF-X	F53
	LCBX1/0-14-X	F79	LCBX8-38F-L	F81	LCC1/0-38WH-X	F50
	LCBX1/0-14F-X	F81	LCBX8-38H-L	F80	LCC1/0-56C-X	F41
	LCBX1/0-14H-X	F80	LCC1-00-E	F56	LCC1/0-56CF-X	F45
	LCBX1/0-38-X	F79	LCC1-00W-E	F57	LCC1/0-56CH-X	F43
	LCBX1/0-38F-X	F81	LCC1-12-E	F40	LCC1/0-56D-X	F41
	LCBX1/0-38H-X	F80	LCC1-12F-E	F45	LCC1/0-56DF-X	F45
	LCBX2-12-E	F79	LCC1-12H-E	F43	LCC1/0-56DH-X	F43
	LCBX2-12F-E	F81	LCC1-12W-E	F47	LCC10-14AW-L	F46
Mechanical Connectors	LCBX2-12H-E	F80	LCC1-12WF-E	F53	LCC10-14AWF-L	F52
	LCBX2-14-E	F79	LCC1-12WH-E	F50	LCC10-14AWH-L	F49
	LCBX2-14F-E	F81	LCC1-14A-E	F40	LCC10-14BW-L	F46
	LCBX2-14H-E	F80	LCC1-14AF-E	F45	LCC10-14BWF-L	F52
	LCBX2-38-E	F79	LCC1-14AH-E	F43	LCC10-14BWH-L	F49
	LCBX2-38F-E	F81	LCC1-14AW-E	F47	LCC1000-00-3	F56
	LCBX2-38H-E	F80	LCC1-14AWF-E	F53	LCC1000-12-3	F41
	LCBX2/0-12-X	F79	LCC1-14AWH-E	F50	LCC1000-12W-3	F48
	LCBX2/0-12F-X	F81	LCC1-14B-E	F40	LCC1000-38D-3	F41
	LCBX2/0-12H-X	F80	LCC1-14BF-E	F45	LCC1000-38DW-3	F48
Grounding Connectors	LCBX2/0-14-X	F79	LCC1-14BH-E	F43	LCC2-00-Q	F56
	LCBX2/0-14F-X	F81	LCC1-14BW-E	F47	LCC2-00W-Q	F57
	LCBX2/0-14H-X	F80	LCC1-14BWF-E	F53	LCC2-10AW-Q	F47
	LCBX2/0-38-X	F79	LCC1-14BWH-E	F50	LCC2-10AWF-Q	F53
	LCBX2/0-38F-X	F81	LCC1-38D-E	F40	LCC2-10AWH-Q	F50
	LCBX2/0-38H-X	F80	LCC1-38DF-E	F45	LCC2-10BW-Q	F47
	LCBX250-38-X	F79	LCC1-38DH-E	F43	LCC2-10BWF-Q	F53
	LCBX250-38F-X	F81	LCC1-38DWE	F47	LCC2-10BWH-Q	F50
	LCBX250-38H-X	F80	LCC1-38DWF-E	F53	LCC2-12-Q	F40
	LCBX3/0-38-X	F79	LCC1-38DWH-E	F50	LCC2-12F-Q	F44
Support Products	LCBX3/0-38F-X	F81	LCC1-56B-E	F40	LCC2-12H-Q	F42
	LCBX3/0-38H-X	F80	LCC1-56BF-E	F45	LCC2-12W-Q	F47
	LCBX300-12F-6	F81	LCC1-56BH-E	F43	LCC2-12WF-Q	F53
	LCBX300-12H-6	F80	LCC1-56BW-E	F47	LCC2-12WH-Q	F50
	LCBX300-38-6	F79	LCC1-56BWF-E	F53	LCC2-14A-Q	F40
	LCBX300-38F-6	F81	LCC1-56BWH-E	F50	LCC2-14AF-Q	F44
	LCBX300-38H-6	F80	LCC1-56C-E	F40	LCC2-14AH-Q	F42
	LCBX350-12-6	F79	LCC1-56CF-E	F45	LCC2-14AW-Q	F47
	LCBX350-12F-6	F81	LCC1-56CH-E	F43	LCC2-14AWF-Q	F53
	Technical Info	LCBX350-12H-6	F80			
LCBX350-38-6		F79				
LCBX350-38F-6		F81				
LCBX350-38H-6		F80				
LCBX350-12-6		F79				
LCBX350-12F-6		F81				
LCBX350-12H-6		F80				
LCBX350-38-6		F79				
LCBX350-38F-6		F81				
LCBX350-38H-6		F80				
Index	LCBX350-12-6	F79				
	LCBX350-12F-6	F81				
	LCBX350-12H-6	F80				
	LCBX350-38-6	F79				
	LCBX350-38F-6	F81				
	LCBX350-38H-6	F80				
	LCBX350-12-6	F79				
	LCBX350-12F-6	F81				
	LCBX350-12H-6	F80				
	LCBX350-38-6	F79				

PANDUIT® TERMINATION SOLUTIONS

• Type LCC Tool Chart Pages L12-L15

Part Number	Page Number
LCC2-14AWH-Q	F50
LCC2-14B-Q	F40
LCC2-14BF-Q	F44
LCC2-14BH-Q	F42
LCC2-14BW-Q	F47
LCC2-14BWF-Q	F53
LCC2-14BWH-Q	F50
LCC2-14DW-Q	F47
LCC2-14DWF-Q	F53
LCC2-14DWH-Q	F50
LCC2-38-Q	F40
LCC2-38BW-Q	F47
LCC2-38BWF-Q	F53
LCC2-38BWH-Q	F50
LCC2-38CW-Q	F47
LCC2-38CWF-Q	F53
LCC2-38CWH-Q	F50
LCC2-38D-Q	F40
LCC2-38DF-Q	F44
LCC2-38DH-Q	F42
LCC2-38DW-Q	F47
LCC2-38DWF-Q	F53
LCC2-38DWH-Q	F50
LCC2-38F-Q	F44
LCC2-38H-Q	F42
LCC2-38W-Q	F47
LCC2-38WF-Q	F53
LCC2-38WH-Q	F50
LCC2-56B-Q	F40
LCC2-56BF-Q	F44
LCC2-56BH-Q	F42
LCC2-56BW-Q	F47
LCC2-56BWF-Q	F53
LCC2-56BWH-Q	F50
LCC2-56C-Q	F40
LCC2-56CF-Q	F44
LCC2-56CH-Q	F42
LCC2-56CW-Q	F47
LCC2-56CWF-Q	F53
LCC2-56CWH-Q	F50
LCC2/0-00-X	F56
LCC2/0-00W-X	F57
LCC2/0-12-X	F41
LCC2/0-12D-X	F41
LCC2/0-12DF-X	F45
LCC2/0-12DH-X	F43
LCC2/0-12DW-X	F47
LCC2/0-12DWF-X	F53
LCC2/0-12DWH-X	F50
LCC2/0-12F-X	F45
LCC2/0-12H-X	F43
LCC2/0-12W-X	F47
LCC2/0-12WF-X	F53
LCC2/0-12WH-X	F50
LCC2/0-14A-X	F41
LCC2/0-14AF-X	F45
LCC2/0-14AH-X	F43
LCC2/0-14AW-X	F47
LCC2/0-14AWF-X	F53
LCC2/0-14AWH-X	F50
LCC2/0-14B-X	F41
LCC2/0-14BF-X	F45
LCC2/0-14BH-X	F43
LCC2/0-14BW-X	F47
LCC2/0-14BWF-X	F53
LCC2/0-14BWH-X	F50
LCC2/0-38D-X	F41
LCC2/0-38DF-X	F45
LCC2/0-38DH-X	F43
LCC2/0-38DW-X	F47
LCC2/0-38DWF-X	F53
LCC2/0-38DWH-X	F50
LCC2/0-56D-X	F41
LCC2/0-56DF-X	F45
LCC2/0-56DH-X	F43

Part Number	Page Number
LCC2/0-56DW-X	F47
LCC2/0-56DWF-X	F53
LCC2/0-56DWH-X	F50
LCC250-00-X	F56
LCC250-00W-X	F57
LCC250-12-X	F41
LCC250-12D-X	F41
LCC250-12DF-X	F45
LCC250-12DH-X	F43
LCC250-12DW-X	F47
LCC250-12DWF-X	F54
LCC250-12DWH-X	F51
LCC250-12F-X	F45
LCC250-12H-X	F43
LCC250-12W-X	F47
LCC250-12WF-X	F54
LCC250-12WH-X	F51
LCC250-38D-X	F41
LCC250-38DF-X	F45
LCC250-38DH-X	F43
LCC250-38DW-X	F47
LCC250-38DWF-X	F54
LCC250-38DWH-X	F51
LCC250-56DW-X	F47
LCC250-56DWF-X	F54
LCC250-56DWH-X	F51
LCC3/0-00-X	F56
LCC3/0-00W-X	F57
LCC3/0-12-X	F41
LCC3/0-12D-X	F41
LCC3/0-12DF-X	F45
LCC3/0-12DH-X	F43
LCC3/0-12DW-X	F47
LCC3/0-12DWF-X	F53
LCC3/0-12DWH-X	F50
LCC3/0-12F-X	F45
LCC3/0-12H-X	F43
LCC3/0-12W-X	F47
LCC3/0-12WF-X	F53
LCC3/0-12WH-X	F50
LCC3/0-14B-X	F41
LCC3/0-14BF-X	F45
LCC3/0-14BH-X	F43
LCC3/0-14BW-X	F47
LCC3/0-14BWF-X	F53
LCC3/0-14BWH-X	F50
LCC3/0-38D-X	F41
LCC3/0-38DF-X	F45
LCC3/0-38DH-X	F43
LCC3/0-38DW-X	F47
LCC3/0-38DWF-X	F53
LCC3/0-38DWH-X	F50
LCC3/0-56DW-X	F47
LCC3/0-56DWF-X	F53
LCC3/0-56DWH-X	F50
LCC300-00-X	F56
LCC300-00W-X	F57
LCC300-12-X	F41
LCC300-12F-X	F45
LCC300-12H-X	F43
LCC300-12W-X	F47
LCC300-12WF-X	F54
LCC300-12WH-X	F51
LCC300-38D-X	F41
LCC300-38DF-X	F45
LCC300-38DH-X	F43
LCC300-38DW-X	F47
LCC300-38DWF-X	F54
LCC300-38DWH-X	F51
LCC350-00-X	F56
LCC350-00W-X	F57
LCC350-12-X	F41
LCC350-12F-X	F45
LCC350-12H-X	F43
LCC350-12W-X	F47

Part Number	Page Number
LCC350-12WF-X	F54
LCC350-12WH-X	F51
LCC350-14B-X	F41
LCC350-14BF-X	F45
LCC350-14BH-X	F43
LCC350-14BW-X	F48
LCC350-14BWF-X	F54
LCC350-14BWH-X	F51
LCC350-38D-X	F41
LCC350-38DF-X	F45
LCC350-38DH-X	F43
LCC350-38DW-X	F48
LCC350-38DWF-X	F54
LCC350-38DWH-X	F51
LCC4-00-L	F56
LCC4-00W-L	F57
LCC4-10AW-L	F46
LCC4-10AWF-L	F53
LCC4-10AWH-L	F50
LCC4-10BW-L	F46
LCC4-10BWF-L	F53
LCC4-10BWH-L	F50
LCC4-12-L	F40
LCC4-12W-L	F46
LCC4-14A-L	F40
LCC4-14AF-L	F44
LCC4-14AH-L	F42
LCC4-14AW-L	F46
LCC4-14AWF-L	F53
LCC4-14AWH-L	F50
LCC4-14B-L	F40
LCC4-14BF-L	F44
LCC4-14BH-L	F42
LCC4-14BW-L	F46
LCC4-14BWF-L	F53
LCC4-14BWH-L	F50
LCC4-14DW-L	F46
LCC4-38D-L	F40
LCC4-38DF-L	F44
LCC4-38DH-L	F42
LCC4-38DW-L	F46
LCC4-38DWF-L	F53
LCC4-38DWH-L	F50
LCC4/0-00-X	F56
LCC4/0-00W-X	F57
LCC4/0-12-X	F41
LCC4/0-12D-X	F41
LCC4/0-12DF-X	F45
LCC4/0-12DH-X	F43
LCC4/0-12DW-X	F47
LCC4/0-12DWF-X	F53
LCC4/0-12DWH-X	F50
LCC4/0-12F-X	F45
LCC4/0-12H-X	F43
LCC4/0-12W-X	F47
LCC4/0-12WF-X	F53
LCC4/0-12WH-X	F50
LCC4/0-14AW-X	F47
LCC4/0-14AWF-X	F53
LCC4/0-14AWH-X	F50
LCC4/0-14B-X	F41
LCC4/0-14BF-X	F45
LCC4/0-14BH-X	F43
LCC4/0-14BW-X	F47
LCC4/0-14BWF-X	F53
LCC4/0-14BWH-X	F50
LCC4/0-38-X	F41
LCC4/0-38D-X	F41
LCC4/0-38DF-X	F45
LCC4/0-38DH-X	F43
LCC4/0-38DW-X	F47
LCC4/0-38DWF-X	F53
LCC4/0-38DWH-X	F50
LCC4/0-38F-X	F45
LCC4/0-38H-X	F43

System Overview

Terminals

Disconnects

Splices

Ferrules

Compression Connectors

Crimping Tools

Mechanical Connectors

Grounding Connectors

Support Products

Technical Info

Index

PANDUIT® TERMINATION SOLUTIONS

• Type LCC Tool Chart [Pages L12-L15](#)
 • Type LCCF Tool Chart [Pages L24-L25](#)

System Overview

Part Number	Page Number	Part Number	Page Number	Part Number	Page Number
LCC4/0-38W-X	F47	LCC6-14DF-L	F44	LCC8-38D-L	F40
LCC4/0-38WF-X	F53	LCC6-14DH-L	F42	LCC8-38DF-L	F44
LCC4/0-38WH-X	F50	LCC6-14DW-L	F46	LCC8-38DH-L	F42
LCC4/0-56D-X	F41	LCC6-14DWF-L	F52	LCC8-38DW-L	F46
LCC4/0-56DF-X	F45	LCC6-14DWH-L	F49	LCC8-38DWF-L	F52
LCC4/0-56DH-X	F43	LCC6-14EW-L	F46	LCC8-38DWH-L	F49
LCC4/0-56DW-X	F47	LCC6-14EWF-L	F52	LCC800-12-6	F41
LCC4/0-56DWF-X	F53	LCC6-14EWH-L	F49	LCC800-12W-6	F48
LCC4/0-56DWH-X	F50	LCC6-14JW-L	F46	LCCF1-12-X	F96
LCC400-00-6	F56	LCC6-14JWF-L	F52	LCCF1-12F-X	F99
LCC400-00W-6	F57	LCC6-14JWH-L	F49	LCCF1-12H-X	F97
LCC400-12-6	F41	LCC6-14W-L	F46	LCCF1-14A-X	F96
LCC400-12F-6	F45	LCC6-38BW-L	F46	LCCF1-14AF-X	F99
LCC400-12H-6	F43	LCC6-38BWF-L	F52	LCCF1-14AH-X	F97
LCC400-12W-6	F48	LCC6-38BWH-L	F49	LCCF1-14B-X	F96
LCC400-12WF-6	F54	LCC6-38CWF-L	F46	LCCF1-14BF-X	F99
LCC400-12WH-6	F51	LCC6-38CWF-L	F52	LCCF1-14BH-X	F97
LCC400-14B-6	F41	LCC6-38CWH-L	F49	LCCF1-38D-X	F96
LCC400-14BF-6	F45	LCC6-38D-L	F40	LCCF1-38DF-X	F99
LCC400-14BH-6	F43	LCC6-38DF-L	F44	LCCF1-38DH-X	F97
LCC400-14BW-6	F48	LCC6-38DH-L	F42	LCCF1-56C-X	F96
LCC400-14BWF-6	F54	LCC6-38DW-L	F46	LCCF1-56CF-X	F99
LCC400-14BWH-6	F51	LCC6-38DWF-L	F52	LCCF1-56CH-X	F97
LCC400-38D-6	F41	LCC6-38DWH-L	F49	LCCF1/0-12-X	F96
LCC400-38DF-6	F45	LCC6-56BW-L	F46	LCCF1/0-12F-X	F99
LCC400-38DH-6	F43	LCC6-56BWF-L	F52	LCCF1/0-12H-X	F97
LCC400-38DW-6	F48	LCC6-56BWH-L	F49	LCCF1/0-14A-X	F96
LCC400-38DWF-6	F54	LCC600-00-6	F56	LCCF1/0-14AF-X	F99
LCC400-38DWH-6	F51	LCC600-00W-6	F57	LCCF1/0-14AH-X	F97
LCC500-00-6	F56	LCC600-12-6	F41	LCCF1/0-14B-X	F96
LCC500-00W-6	F57	LCC600-12F-6	F45	LCCF1/0-14BF-X	F99
LCC500-12-6	F41	LCC600-12H-6	F43	LCCF1/0-14BH-X	F97
LCC500-12F-6	F45	LCC600-12W-6	F48	LCCF1/0-38D-X	F96
LCC500-12H-6	F43	LCC600-12WF-6	F54	LCCF1/0-38DF-X	F99
LCC500-12W-6	F48	LCC600-12WH-6	F51	LCCF1/0-38DH-X	F97
LCC500-12WF-6	F54	LCC600-38D-6	F41	LCCF1/0-56C-X	F96
LCC500-12WH-6	F51	LCC600-38DF-6	F45	LCCF1/0-56CF-X	F99
LCC500-14B-6	F41	LCC600-38DH-6	F43	LCCF1/0-56CH-X	F97
LCC500-14BF-6	F45	LCC600-38DW-6	F48	LCCF2-12-E	F96
LCC500-14BH-6	F43	LCC600-38DWF-6	F54	LCCF2-12F-E	F99
LCC500-14BW-6	F48	LCC600-38DWH-6	F51	LCCF2-12H-E	F97
LCC500-14BWF-6	F54	LCC750-00-6	F56	LCCF2-14A-E	F96
LCC500-14BWH-6	F51	LCC750-12-6	F41	LCCF2-14AH-E	F97
LCC500-38D-6	F41	LCC750-12W-6	F48	LCCF2-14B-E	F96
LCC500-38DF-6	F45	LCC750-38D-6	F41	LCCF2-14BF-E	F99
LCC500-38DH-6	F43	LCC750-38DW-6	F48	LCCF2-14BH-E	F97
LCC500-38DW-6	F48	LCC8-00-L	F56	LCCF2-38D-E	F96
LCC500-38DWF-6	F54	LCC8-00W-L	F57	LCCF2-38DF-E	F99
LCC500-38DWH-6	F51	LCC8-10A-L	F40	LCCF2-38DH-E	F97
LCC6-00-L	F56	LCC8-10AF-L	F44	LCCF2-56B-E	F96
LCC6-00W-L	F57	2LCC8-10AH-L	F42	LCCF2-56BF-E	F99
LCC6-10A-L	F40	LCC8-10AW-L	F46	LCCF2-56BH-E	F97
LCC6-10AF-L	F44	LCC8-10AWF-L	F52	LCCF2/0-12-X	F96
LCC6-10AH-L	F42	LCC8-10AWH-L	F49	LCCF2/0-12F-X	F99
LCC6-10AW-L	F46	LCC8-10BW-L	F46	LCCF2/0-12H-X	F97
LCC6-10AWF-L	F52	LCC8-10BWF-L	F52	LCCF2/0-14A-X	F96
LCC6-10AWH-L	F49	LCC8-10BWH-L	F49	LCCF2/0-14AF-X	F99
LCC6-10BW-L	F46	LCC8-14A-L	F40	LCCF2/0-14AH-X	F97
LCC6-10BWF-L	F52	LCC8-14AF-L	F44	LCCF2/0-14B-X	F96
LCC6-10BWH-L	F49	LCC8-14AH-L	F42	LCCF2/0-14BF-X	F99
LCC6-12-L	F40	LCC8-14AW-L	F46	LCCF2/0-14BH-X	F97
LCC6-12W-L	F46	LCC8-14AWF-L	F52	LCCF2/0-38D-X	F96
LCC6-14A-L	F40	LCC8-14AWH-L	F49	LCCF2/0-38DF-X	F99
LCC6-14AF-L	F44	LCC8-14B-L	F40	LCCF2/0-38DH-X	F97
LCC6-14AH-L	F42	LCC8-14BF-L	F44	LCCF250-12-X	F96
LCC6-14AW-L	F46	LCC8-14BH-L	F42	LCCF250-12E-X	F96
LCC6-14AWF-L	F52	LCC8-14BW-L	F46	LCCF250-12EF-X	F100
LCC6-14AWH-L	F49	LCC8-14BWF-L	F52	LCCF250-12EH-X	F98
LCC6-14B-L	F40	LCC8-14BWH-L	F49	LCCF250-12F-X	F100
LCC6-14BF-L	F44	LCC8-14D-L	F40	LCCF250-12H-X	F98
LCC6-14BH-L	F42	LCC8-14DF-L	F44	LCCF250-14B-X	F96
LCC6-14BW-L	F46	LCC8-14DH-L	F42	LCCF250-14BF-X	F100
LCC6-14BWF-L	F52	LCC8-14DW-L	F46	LCCF250-14BH-X	F98
LCC6-14BWH-L	F49	LCC8-14DWF-L	F52	LCCF250-38D-X	F96
LCC6-14D-L	F40	LCC8-14DWH-L	F49	LCCF250-38DF-X	F100

PANDUIT® TERMINATION SOLUTIONS

• Type LCCF Tool Chart [Pages L24-L25](#)
 • Type LCCH Tool Chart [Pages L16-L17](#)

• Type LCCN Tool Chart [Pages L12-L15](#)
 • Type LCCX Tool Chart [Pages L22-L23](#)

Part Number	Page Number
LCCF250-38DH-X	F98
LCCF3/0-12-X	F96
LCCF3/0-12F-X	F99
LCCF3/0-12H-X	F97
LCCF3/0-14B-X	F96
LCCF3/0-14BF-X	F99
LCCF3/0-14BH-X	F97
LCCF3/0-38D-X	F96
LCCF3/0-38DF-X	F99
LCCF3/0-38DH-X	F97
LCCF300-12-6	F96
LCCF300-12F-6	F100
LCCF300-12H-6	F98
LCCF300-14B-6	F96
LCCF300-14BF-6	F100
LCCF300-14BH-6	F98
LCCF300-38D-6	F96
LCCF300-38DF-6	F100
LCCF300-38DH-6	F98
LCCF350-12-6	F96
LCCF350-12E-6	F96
LCCF350-12EF-6	F100
LCCF350-12EH-6	F98
LCCF350-12F-6	F100
LCCF350-12H-6	F98
LCCF350-14B-6	F96
LCCF350-14BF-6	F100
LCCF350-14BH-6	F98
LCCF350-38D-6	F96
LCCF350-38DF-6	F100
LCCF350-38DH-6	F98
LCCF4-14A-L	F95
LCCF4-14AF-L	F99
LCCF4-14AH-L	F97
LCCF4-14B-L	F95
LCCF4-14BF-L	F99
LCCF4-14BH-L	F97
LCCF4-38D-L	F95
LCCF4-38DH-L	F97
LCCF4/0-12-X	F96
LCCF4/0-12F-X	F100
LCCF4/0-12H-X	F98
LCCF4/0-14B-X	F96
LCCF4/0-14BF-X	F100
LCCF4/0-14BH-X	F98
LCCF4/0-38-X	F96
LCCF4/0-38D-X	F96
LCCF4/0-38DF-X	F100
LCCF4/0-38DH-X	F98
LCCF4/0-38F-X	F100
LCCF4/0-38H-X	F98
LCCF400-12-6	F96
LCCF400-12F-6	F100
LCCF400-12H-6	F98
LCCF400-38D-6	F96
LCCF400-38DF-6	F100
LCCF400-38DH-6	F98
LCCF500-12-6	F96
LCCF500-12F-6	F100
LCCF500-12H-6	F98
LCCF6-14A-L	F95
LCCF6-14AF-L	F99
LCCF6-14AH-L	F97
LCCF6-14B-L	F95
LCCF6-14BF-L	F99
LCCF6-14BH-L	F97
LCCF6-38D-L	F95
LCCF6-38DF-L	F99
LCCF6-38DH-L	F97
LCCF600-12-6	F96
LCCF600-12F-6	F100
LCCF600-12H-6	F98
LCCF750-12-3	F96
LCCF750-12F-3	F100
LCCF750-12H-3	F98

Part Number	Page Number
LCCF750-38D-3	F96
LCCF750-38DF-3	F100
LCCF750-38DH-3	F98
LCCF8-14A-L	F95
LCCF8-14AF-L	F99
LCCF8-14AH-L	F97
LCCF8-14B-L	F95
LCCF8-14BF-L	F99
LCCF8-14BH-L	F97
LCCF8-38D-L	F95
LCCF8-38DF-L	F99
LCCF8-38DH-L	F97
LCCH1/0-12-X	F55
LCCH1000-12-3	F55
LCCH2/0-12-X	F55
LCCH250-12-X	F55
LCCH3/0-12-X	F55
LCCH300-12-X	F55
LCCH350-12-X	F55
LCCH4/0-12-X	F55
LCCH400-12-6	F55
LCCH500-12-6	F55
LCCH600-12-6	F55
LCCH750-12-6	F55
LCCN750-12W-6	F54
LCCN750-38DW-6	F54
LCCX1-14A-X	F91
LCCX1-14AF-X	F94
LCCX1-14AH-X	F93
LCCX1-14B-X	F91
LCCX1-14BF-X	F94
LCCX1-14BH-X	F93
LCCX1-14D-X	F91
LCCX1-14DF-X	F94
LCCX1-14DH-X	F93
LCCX1-38D-X	F91
LCCX1-38DF-X	F94
LCCX1-38DH-X	F93
LCCX1-56C-X	F91
LCCX1-56CF-X	F94
LCCX1-56CH-X	F93
LCCX1-56D-X	F91
LCCX1-56DF-X	F94
LCCX1-56DH-X	F93
LCCX1/0-12-X	F91
LCCX1/0-12F-X	F94
LCCX1/0-12H-X	F93
LCCX1/0-14A-X	F91
LCCX1/0-14AF-X	F94
LCCX1/0-14AH-X	F93
LCCX1/0-14B-X	F91
LCCX1/0-14BF-X	F94
LCCX1/0-14BH-X	F93
LCCX1/0-38D-X	F91
LCCX1/0-38DF-X	F94
LCCX1/0-38DH-X	F93
LCCX2-12-E	F91
LCCX2-12F-E	F94
LCCX2-12H-E	F93
LCCX2-14A-E	F91
LCCX2-14AF-E	F94
LCCX2-14AH-E	F93
LCCX2-14B-E	F91
LCCX2-14BF-E	F94
LCCX2-14BH-E	F93
LCCX2-38D-E	F91
LCCX2-38DF-E	F94
LCCX2-38DH-E	F93
LCCX2/0-12-X	F92
LCCX2/0-12F-X	F95
LCCX2/0-12H-X	F93
LCCX2/0-14A-X	F92
LCCX2/0-14AF-X	F95
LCCX2/0-14AH-X	F93
LCCX2/0-14B-X	F92

Part Number	Page Number
LCCX2/0-14BF-X	F95
LCCX2/0-14BH-X	F93
LCCX2/0-38D-X	F92
LCCX2/0-38DF-X	F95
LCCX2/0-38DH-X	F93
LCCX250-14B-X	F92
LCCX250-14BF-X	F95
LCCX250-14BH-X	F93
LCCX250-38D-X	F92
LCCX250-38DF-X	F95
LCCX250-38DH-X	F93
LCCX3/0-14B-X	F92
LCCX3/0-14BF-X	F95
LCCX3/0-14BH-X	F93
LCCX3/0-38D-X	F92
LCCX3/0-38DF-X	F95
LCCX3/0-38DH-X	F93
LCCX300-38D-6	F92
LCCX300-38DF-6	F95
LCCX300-38DH-6	F93
LCCX350-12-6	F92
LCCX350-12F-6	F95
LCCX350-12H-6	F93
LCCX350-14B-6	F92
LCCX350-14BF-6	F95
LCCX350-14BH-6	F93
LCCX350-38D-6	F92
LCCX350-38DF-6	F95
LCCX350-38DH-6	F93
LCCX4-14A-L	F91
LCCX4-14AF-L	F94
LCCX4-14AH-L	F93
LCCX4-14B-L	F91
LCCX4-14BF-L	F94
LCCX4-14BH-L	F93
LCCX4-38B-L	F91
LCCX4-38BF-L	F94
LCCX4-38BH-L	F93
LCCX4-38D-L	F91
LCCX4-38DF-L	F94
LCCX4-38DH-L	F93
LCCX4/0-12-X	F92
LCCX4/0-12F-X	F95
LCCX4/0-12H-X	F93
LCCX4/0-14B-X	F92
LCCX4/0-14BF-X	F95
LCCX4/0-14BH-X	F93
LCCX4/0-38D-X	F92
LCCX4/0-38DF-X	F95
LCCX4/0-38DH-X	F93
LCCX500-12-6	F92
LCCX6-10B-L	F91
LCCX6-10BF-L	F94
LCCX6-10BH-L	F93
LCCX6-14A-L	F91
LCCX6-14AF-L	F94
LCCX6-14AH-L	F93
LCCX6-14B-L	F91
LCCX6-14BF-L	F94
LCCX6-14BH-L	F93
LCCX6-14D-L	F91
LCCX6-14DF-L	F94
LCCX6-14DH-L	F93
LCCX6-38A-L	F91
LCCX6-38AF-L	F94
LCCX6-38AH-L	F93
LCCX6-38C-L	F91
LCCX6-38CF-L	F94
LCCX6-38CH-L	F93
LCCX6-38D-L	F91
LCCX6-38DF-L	F94
LCCX6-38DH-L	F93
LCCX8-10A-L	F91
LCCX8-10AF-L	F94
LCCX8-10AH-L	F92

System Overview

Terminals

Disconnects

Splices

Ferrules

Compression Connectors

Crimping Tools

Mechanical Connectors

Grounding Connectors

Support Products

Technical Info

Index

PANDUIT® TERMINATION SOLUTIONS

• Type LCCX Tool Chart [Pages L22-L23](#)
 • Type LCD Tool Chart [Pages L8-L11](#)

System Overview	Part Number	Page Number	Part Number	Page Number	Part Number	Page Number
Terminals	LCCX8-10B-L	F91	LCD2-56B-Q	F31	LCD4-38DF-L	F35
	LCCX8-10BF-L	F94	LCD2-56BF-Q	F36	LCD4-38DH-L	F33
	LCCX8-10BH-L	F92	LCD2-56BH-Q	F34	LCD4/0-00-X	F39
	LCCX8-14A-L	F91	LCD2/0-00-X	F39	LCD4/0-12-X	F32
	LCCX8-14AF-L	F94	LCD2/0-12-X	F32	LCD4/0-12F-X	F36
	LCCX8-14AH-L	F92	LCD2/0-12F-X	F36	LCD4/0-12H-X	F34
	LCCX8-14B-L	F91	LCD2/0-12H-X	F34	LCD4/0-14B-X	F32
	LCCX8-14BF-L	F94	LCD2/0-14A-X	F32	LCD4/0-14BF-X	F36
	LCCX8-14BH-L	F92	LCD2/0-14AF-X	F36	LCD4/0-14BH-X	F34
	LCCX8-14D-L	F91	LCD2/0-14AH-X	F34	LCD4/0-38D-X	F32
Disconnects	LCCX8-14DF-L	F94	LCD2/0-14B-X	F32	LCD4/0-38DF-X	F36
	LCCX8-14DH-L	F92	LCD2/0-14BF-X	F36	LCD4/0-38DH-X	F34
	LCCX8-38D-L	F91	LCD2/0-14BH-X	F34	LCD400-00-6	F39
	LCCX8-38DF-L	F94	LCD2/0-38D-X	F32	LCD400-12-6	F32
	LCCX8-38DH-L	F92	LCD2/0-38DF-X	F36	LCD400-12F-6	F36
	LCD1-12-E	F32	LCD2/0-38DH-X	F34	LCD400-12H-6	F34
	LCD1-12F-E	F36	LCD2/0-56C-X	F32	LCD400-38D-6	F32
	LCD1-12H-E	F34	LCD2/0-56CF-X	F36	LCD400-38DF-6	F36
	LCD1-14A-E	F32	LCD2/0-56CH-X	F34	LCD400-38DH-6	F34
	LCD1-14AF-E	F36	LCD250-00-X	F39	LCD500-00-6	F39
Splices	LCD1-14AH-E	F34	LCD250-12-X	F32	LCD500-12-6	F32
	LCD1-14B-E	F32	LCD250-12F-X	F36	LCD500-12E-6	F32
	LCD1-14BF-E	F36	LCD250-12H-X	F34	LCD500-12EF-6	F36
	LCD1-14BH-E	F34	LCD250-38D-X	F32	LCD500-12EH-6	F34
	LCD1-38D-E	F32	LCD250-38DF-X	F36	LCD500-12F-6	F36
	LCD1-38DF-E	F36	LCD250-38DH-X	F34	LCD500-12H-6	F34
	LCD1-38DH-E	F34	LCD3/0-00-X	F39	LCD500-14B-6	F32
	LCD1-56C-E	F32	LCD3/0-12-X	F32	LCD500-14BF-6	F36
	LCD1-56CF-E	F36	LCD3/0-12F-X	F36	LCD500-14BH-6	F34
	LCD1-56CH-E	F34	LCD3/0-12H-X	F34	LCD500-38D-6	F32
Ferrules	LCD1/0-00-X	F39	LCD3/0-14B-X	F32	LCD500-38DF-6	F36
	LCD1/0-12-X	F32	LCD3/0-14BF-X	F36	LCD500-38DH-6	F34
	LCD1/0-12F-X	F36	LCD3/0-14BH-X	F34	LCD6-10A-L	F31
	LCD1/0-12H-X	F34	LCD3/0-38D-X	F32	LCD6-10AF-L	F35
	LCD1/0-14A-X	F32	LCD3/0-38DF-X	F36	LCD6-10AH-L	F33
	LCD1/0-14AF-X	F36	LCD3/0-38DH-X	F34	LCD6-10B-L	F31
	LCD1/0-14AH-X	F34	LCD3/0-56D-X	F32	LCD6-10BF-L	F35
	LCD1/0-14B-X	F32	LCD3/0-56DF-X	F36	LCD6-10BH-L	F33
	LCD1/0-14BF-X	F36	LCD3/0-56DH-X	F34	LCD6-10D-L	F31
	LCD1/0-14BH-X	F34	LCD300-00-X	F39	LCD6-10DF-L	F35
Crimping Tools	LCD1/0-38D-X	F32	LCD300-12-X	F32	LCD6-10DH-L	F33
	LCD1/0-38DF-X	F36	LCD300-12F-X	F36	LCD6-14A-L	F31
	LCD1/0-38DH-X	F34	LCD300-12H-X	F34	LCD6-14AF-L	F35
	LCD1/0-56C-X	F32	LCD300-38D-X	F32	LCD6-14AH-L	F33
	LCD1/0-56CF-X	F36	LCD300-38DF-X	F36	LCD6-14B-L	F31
	LCD1/0-56CH-X	F34	LCD300-38DH-X	F34	LCD6-14BF-L	F35
	LCD10-10A-L	F31	LCD350-00-X	F39	LCD6-14BH-L	F33
	LCD10-10AF-L	F35	LCD350-12-X	F32	LCD6-14D-L	F31
	LCD10-10AH-L	F33	LCD350-12E-X	F32	LCD6-14DF-L	F35
	LCD10-14A-L	F31	LCD350-12EF-X	F36	LCD6-14DH-L	F33
Mechanical Connectors	LCD10-14AF-L	F35	LCD350-12EH-X	F34	LCD6-38D-L	F31
	LCD10-14AH-L	F33	LCD350-12F-X	F36	LCD6-38DF-L	F35
	LCD10-14A-L	F31	LCD350-12H-X	F34	LCD6-38DH-L	F33
	LCD10-14AF-L	F35	LCD350-14B-X	F32	LCD6-56D-L	F31
	LCD10-14AH-L	F33	LCD350-14BF-X	F36	LCD6-56DF-L	F35
	LCD10-14B-L	F31	LCD350-14BH-X	F34	LCD6-56DH-L	F33
	LCD10-14D-L	F31	LCD350-38D-X	F32	LCD600-00-6	F39
	LCD10-38D-L	F31	LCD350-38DF-X	F36	LCD600-12-6	F32
	LCD10-38DF-L	F35	LCD350-38DH-X	F34	LCD600-12F-6	F36
	LCD10-38DH-L	F33	LCD4-10A-L	F31	LCD600-12H-6	F34
Support Products	LCD1000-00-3	F39	LCD4-10AF-L	F35	LCD600-38D-6	F32
	LCD1000-12-3	F32	LCD4-10AH-L	F33	LCD600-38DF-6	F36
	LCD1000-12E-3	F32	LCD4-10B-L	F31	LCD600-38DH-6	F34
	LCD2-12-Q	F31	LCD4-10BF-L	F35	LCD750-00-6	F39
	LCD2-12F-Q	F36	LCD4-10BH-L	F33	LCD750-12-6	F32
	LCD2-12H-Q	F34	LCD4-14A-L	F31	LCD750-38D-6	F32
	LCD2-14A-Q	F31	LCD4-14AF-L	F35	LCD8-10A-L	F31
	LCD2-14AF-Q	F36	LCD4-14AH-L	F33	LCD8-10AF-L	F35
	LCD2-14AH-Q	F34	LCD4-14B-L	F31	LCD8-10AH-L	F33
	LCD2-14B-Q	F31	LCD4-14BF-L	F35	LCD8-14A-L	F31
Technical Info	LCD2-14BF-Q	F36	LCD4-14BH-L	F33	LCD8-14AF-L	F35
	LCD2-14BH-Q	F34	LCD4-14D-L	F31	LCD8-14AH-L	F33
	LCD2-14D-Q	F31	LCD4-14DF-L	F35	LCD8-14B-L	F31
	LCD2-14DF-Q	F36	LCD4-14DH-L	F33	LCD8-14BF-L	F35
	LCD2-14DH-Q	F34	LCD4-38D-L	F31	LCD8-14BH-L	F33
	LCD2-38D-Q	F31				
	LCD2-38DF-Q	F36				
	LCD2-38DH-Q	F34				
Index						

PANDUIT® TERMINATION SOLUTIONS

• Type LCD Tool Chart [Pages L8-L11](#)
 • Type LCDN Tool Chart [Pages L8-L11](#)

• Type LCDX Tool Chart [Pages L22-L23](#)

Part Number	Page Number
LCD8-14D-L	F31
LCD8-14DF-L	F35
LCD8-14DH-L	F33
LCD8-38D-L	F31
LCD8-38DF-L	F35
LCD8-38DH-L	F33
LCDN1-14B-E	F37
LCDN1/0-14D-X	F37
LCDN1/0-14DF-X	F38
LCDN1/0-14DH-X	F38
LCDN1/0-56D-X	F37
LCDN1/0-56DF-X	F38
LCDN1/0-56DH-X	F38
LCDN2-14A-Q	F37
LCDN2-14AF-Q	F38
LCDN2-14AH-Q	F38
LCDN2-14B-Q	F37
LCDN2-14D-Q	F37
LCDN2-14DF-Q	F38
LCDN2-14DH-Q	F38
LCDN2/0-14A-X	F37
LCDN2/0-14D-X	F37
LCDN2/0-56A-X	F37
LCDN2/0-56D-X	F37
LCDN350-38D-X	F37
LCDN500-12D-6	F37
LCDN500-38D-6	F37
LCDN750-12D-6	F37
LCDN750-12DF-6	F38
LCDN750-12DH-6	F38
LCDN750-38D-6	F37
LCDN750-38DF-6	F38
LCDN750-38DH-6	F38
LCDX1-12-X	F82
LCDX1-12F-X	F86
LCDX1-12H-X	F84
LCDX1-14A-X	F82
LCDX1-14AF-X	F86
LCDX1-14AH-X	F84
LCDX1-14B-X	F82
LCDX1-14BF-X	F86
LCDX1-14BH-X	F84
LCDX1-14D-X	F82
LCDX1-14DF-X	F86
LCDX1-14DH-X	F84
LCDX1-38D-X	F86
LCDX1-38DF-X	F86
LCDX1-38DH-X	F84
LCDX1-56D-X	F82
LCDX1-56DF-X	F86
LCDX1-56DH-X	F84
LCDX1/0-12-X	F83
LCDX1/0-12D-X	F83
LCDX1/0-12DF-X	F87
LCDX1/0-12DH-X	F85
LCDX1/0-12F-X	F87
LCDX1/0-12H-X	F85
LCDX1/0-14A-X	F83
LCDX1/0-14AF-X	F87
LCDX1/0-14AH-X	F85
LCDX1/0-14B-X	F83
LCDX1/0-14BF-X	F87
LCDX1/0-14BH-X	F85
LCDX1/0-38D-X	F83
LCDX1/0-38DF-X	F87
LCDX1/0-38DH-X	F85
LCDX1/0-56B-X	F83
LCDX1/0-56BF-X	F87
LCDX1/0-56BH-X	F85
LCDX1/0-56D-X	F83
LCDX1/0-56DF-X	F87
LCDX1/0-56DH-X	F85
LCDX2-12-E	F82
LCDX2-12F-E	F86
LCDX2-12H-E	F84

Part Number	Page Number
LCDX2-14A-E	F82
LCDX2-14AF-E	F86
LCDX2-14AH-E	F84
LCDX2-14B-E	F82
LCDX2-14BF-E	F86
LCDX2-14BH-E	F84
LCDX2-14D-E	F82
LCDX2-14DF-E	F86
LCDX2-14DH-E	F84
LCDX2-38D-E	F82
LCDX2-38DF-E	F86
LCDX2-38DH-E	F84
LCDX2-56D-E	F82
LCDX2-56DF-E	F86
LCDX2-56DH-E	F84
LCDX2/0-12-X	F83
LCDX2/0-12D-X	F83
LCDX2/0-12DF-X	F87
LCDX2/0-12DH-X	F85
LCDX2/0-12F-X	F87
LCDX2/0-12H-X	F85
LCDX2/0-14A-X	F83
LCDX2/0-14AF-X	F87
LCDX2/0-14AH-X	F85
LCDX2/0-14B-X	F83
LCDX2/0-14BF-X	F87
LCDX2/0-14BH-X	F85
LCDX2/0-38D-X	F83
LCDX2/0-38DF-X	F87
LCDX2/0-38DH-X	F85
LCDX2/0-56D-X	F83
LCDX2/0-56DF-X	F87
LCDX2/0-56DH-X	F85
LCDX250-12-X	F83
LCDX250-12E-X	F83
LCDX250-12EF-X	F87
LCDX250-12EH-X	F85
LCDX250-12F-X	F87
LCDX250-12H-X	F85
LCDX250-38-X	F83
LCDX250-38D-X	F83
LCDX250-38DF-X	F87
LCDX250-38DH-X	F85
LCDX250-38F-X	F87
LCDX250-38H-X	F85
LCDX3/0-12-X	F83
LCDX3/0-12F-X	F87
LCDX3/0-12H-X	F85
LCDX3/0-14A-X	F83
LCDX3/0-14AF-X	F87
LCDX3/0-14AH-X	F85
LCDX3/0-38D-X	F83
LCDX3/0-38DF-X	F87
LCDX3/0-38DH-X	F85
LCDX3/0-56D-X	F83
LCDX3/0-56DF-X	F87
LCDX3/0-56DH-X	F85
LCDX300-12-6	F83
LCDX300-12F-6	F87
LCDX300-12H-6	F85
LCDX300-38D-6	F83
LCDX300-38DF-6	F87
LCDX300-38DH-6	F85
LCDX350-12-6	F83
LCDX350-12E-6	F87
LCDX350-12EF-6	F87
LCDX350-12F-6	F87
LCDX350-12H-6	F85
LCDX350-38-6	F83
LCDX350-38D-6	F83
LCDX350-38DF-6	F87
LCDX350-38DH-6	F85
LCDX350-38F-6	F87
LCDX350-38H-6	F85

Part Number	Page Number
LCDX350-56D-6	F83
LCDX350-56DF-6	F87
LCDX350-56DH-6	F85
LCDX4-14A-L	F82
LCDX4-14AF-L	F86
LCDX4-14AH-L	F84
LCDX4-14B-L	F82
LCDX4-14BF-L	F86
LCDX4-14BH-L	F84
LCDX4-14D-L	F82
LCDX4-14DF-L	F86
LCDX4-14DH-L	F84
LCDX4-38D-L	F82
LCDX4-38DF-L	F86
LCDX4-38DH-L	F84
LCDX4-56D-L	F82
LCDX4-56DF-L	F86
LCDX4-56DH-L	F84
LCDX4/0-12-X	F83
LCDX4/0-12D-X	F83
LCDX4/0-12DF-X	F87
LCDX4/0-12DH-X	F85
LCDX4/0-12E-X	F83
LCDX4/0-12EF-X	F87
LCDX4/0-12EH-X	F85
LCDX4/0-12F-X	F87
LCDX4/0-12H-X	F85
LCDX4/0-14A-X	F83
LCDX4/0-14AF-X	F87
LCDX4/0-14AH-X	F85
LCDX4/0-14B-X	F83
LCDX4/0-14BF-X	F87
LCDX4/0-14BH-X	F85
LCDX4/0-38D-X	F83
LCDX4/0-38DF-X	F87
LCDX4/0-38DH-X	F85
LCDX4/0-56D-X	F83
LCDX4/0-56DF-X	F87
LCDX4/0-56DH-X	F85
LCDX450-12-6	F83
LCDX450-12F-6	F87
LCDX450-12H-6	F85
LCDX450-38D-6	F83
LCDX450-38DF-6	F87
LCDX450-38DH-6	F85
LCDX500-12-6	F83
LCDX500-12E-6	F87
LCDX500-12EF-6	F87
LCDX500-12EH-6	F85
LCDX500-12F-6	F87
LCDX500-12H-6	F85
LCDX500-38D-6	F83
LCDX500-38DF-6	F87
LCDX500-38DH-6	F85
LCDX500-56D-6	F83
LCDX500-56DF-6	F87
LCDX500-56DH-6	F85
LCDX6-10A-L	F82
LCDX6-10AF-L	F86
LCDX6-10AH-L	F84
LCDX6-10B-L	F82
LCDX6-10BF-L	F86
LCDX6-10BH-L	F84
LCDX6-10G-L	F82
LCDX6-10GF-L	F86
LCDX6-10GH-L	F84
LCDX6-10P-L	F82
LCDX6-10PF-L	F86
LCDX6-10PH-L	F84
LCDX6-14A-L	F82
LCDX6-14AF-L	F86
LCDX6-14AH-L	F84
LCDX6-14B-L	F82
LCDX6-14BF-L	F86
LCDX6-14BH-L	F84

System Overview

Terminals

Disconnects

Splices

Ferrules

Compression Connectors

Crimping Tools

Mechanical Connectors

Grounding Connectors

Support Products

Technical Info

Index

PANDUIT® TERMINATION SOLUTIONS

• Type LCDX Tool Chart [Pages L22-L23](#)
 • Type LCDXN Tool Chart [Pages L22-L23](#)

System Overview

	Part Number	Page Number	Part Number	Page Number	Part Number	Page Number
Terminals	LCDX6-14D-L	F82	ML250-Q	H11	P18-10RHT6-C	B14
	LCDX6-14DF-L	F86	ML250T-Q	H11	P18-10SLF-C	B24
	LCDX6-14DH-L	F84	ML4-C	H11	P18-12R-C	B13
	LCDX6-38D-L	F82	ML4T-C	H11	P18-14F-C	B23
	LCDX6-38DF-L	F86	ML500-3	H11	P18-14R-C	B13
	LCDX6-38DH-L	F84	ML8-C	H11	P18-38R-C	B13
Disconnects	LCDX6-56D-L	F82	ML8T-C	H11	P18-4R-C	B13
	LCDX6-56DF-L	F86			P18-56R-C	B13
	LCDX6-56DH-L	F84			P18-610R-C	B14
	LCDX600-12-6	F83			P18-6F-C	B23
	LCDX600-12F-6	F87			P18-6FN-C	B23
	LCDX600-12H-6	F85			P18-6LF-C	B24
	LCDX650-12-6	F83			P18-6LFW-C	B24
	LCDX650-12F-6	F87			P18-6R-C	B13
	LCDX650-12H-6	F85			P18-6RHT6-C	B14
	LCDX650-38D-6	F83			P18-6RN-C	B13
	LCDX650-38DF-6	F87			P18-6SLF-C	B24
Splices	LCDX650-38DH-6	F85			P18-8F-C	B23
	LCDX750-12-3	F83			P18-8FF-C	B23
	LCDX750-12E-3	F83			P18-8LF-C	B24
	LCDX750-12EF-3	F87			P18-8R-C	B13
	LCDX750-12EH-3	F85			P18-8RHT6-C	B14
	LCDX750-12F-3	F87			P18-8SLF-C	B24
	LCDX750-12G-3	F83			P18-P47-C	C9
	LCDX750-12GF-3	F87			P2-10R-X	B15
	LCDX750-12GH-3	F85			P2-12R-X	B15
	LCDX750-12H-3	F85			P2-14R-X	B15
	LCDX750-38D-3	F83			P2-38R-X	B15
Compression Connectors	LCDX750-38DF-3	F87			P2-56R-X	B15
	LCDX750-38DH-3	F85			P22-10R-C	B13
	LCDX750-58G-3	F83			P22-2F-C	B23
	LCDX750-58GF-3	F87			P22-2R-C	B13
	LCDX750-58GH-3	F85			P22-4F-C	B23
	LCDX8-10A-L	F82			P22-4R-C	B13
	LCDX8-10AF-L	F86			P22-6F-C	B23
	LCDX8-10AH-L	F84			P22-6R-C	B13
	LCDX8-14A-L	F82			P22-8R-C	B13
	LCDX8-14AF-L	F86			P2NLT-500-3	H16
	LCDX8-14AH-L	F84			P4-10R-E	B15
Crimping Tools	LCDX8-14B-L	F82			P4-12R-E	B15
	LCDX8-14BF-L	F86			P4-14R-E	B15
	LCDX8-14BH-L	F84			P4-38R-E	B15
	LCDX8-14D-L	F82			P4-56R-E	B15
	LCDX8-14DF-L	F86			P6-10R-E	B15
	LCDX8-14DH-L	F84			P6-12R-E	B15
	LCDX8-38D-L	F82			P6-14R-E	B15
	LCDX8-38DF-L	F86			P6-38R-E	B15
	LCDX8-38DH-L	F84			P6-56R-E	B15
	LCDXN2-14A-E	F88			P6-8R-E	B15
	LCDXN350-38D-6	F88			P8-10R-Q	B15
Grounding Connectors	LCDXN4/0-38D-X	F88			P8-12R-Q	B15
	LCDXN500-38D-6	F88			P8-14R-Q	B15
	LCDXN750-12-3	F88			P8-38R-Q	B15
	LCDXN750-38D-3	F88			P8-56R-Q	B15
	LCDXN750-38DF-3	F90			P8-8R-Q	B15
	LCDXN750-38DH-3	F89			PCSB2/0-2-12	H31
	LS3-RIB	K30			PCSB2/0-2S-6	H30
	LS3E-KIT	K30			PCSB2/0-3-6	H31
	LS6-ACS	K29			PCSB2/0-4-6	H31
	LS6-BP	K29			PCSB2/0-5-6	H31
	LS6-CLN	K29			PCSB2/0-6-6	H31
Support Products	LS6-KIT	K29			PCSB2/0-7-4	H31
	LS6-PCKIT	K29			PCSB2/0-8-4	H31
	LS6-RHBLK	K29			PCSB250-2-6	H31
	LS6-RRBLK	K29			PCSB250-3-6	H31
	LS6-RRWHT	K29			PCSB250-4-6	H31
	LS6-RWBLK	K29			PCSB250-5-4	H31
	LS7	K29			PCSB250-6-4	H31
	LS7-75NL-1	K33			PCSB250-7-3	H31
	LS7-75NL-2	K33			PCSB250-8-3	H31
	LS7-ACS	K29			PCSB350-2-4	H31
	LS7-CLN	K29			PCSB350-3-4	H31
Index					PCSB350-4-3	H31
					PCSB350-5-3	H31
					PCSB350-6-2	H31

PANDUIT® TERMINATION SOLUTIONS

Part Number	Page Number
-------------	-------------

PCSB350-7-2	.H31
PCSB350-8-2	.H31
PCSB4-2-12	.H31
PCSB4-3-12	.H31
PCSB4-4-6	.H31
PCSB4-5-6	.H31
PCSB4-6-6	.H31
PCSB4-7-4	.H31
PCSB4-8-4	.H31
PCSB500-2-4	.H31
PCSB500-3-3	.H31
PCSB500-4-2	.H31
PCSB500-5-2	.H31
PCSB500-6-2	.H31
PCSB500-7-2	.H31
PCSB500-8-2	.H31
PCSB600-5-2	.H31
PD-600	.G11
PG-1	.G31
PH10-10F-E	.B25
PH10-10R-E	.B10
PH10-12R-E	.B10
PH10-14R-E	.B10
PH10-38R-E	.B10
PH10-8F-E	.B25
PH10-8R-E	.B10
PH14-10F-Q	.B25
PH14-10R-Q	.B10
PH14-14R-Q	.B10
PH14-38R-Q	.B10
PH14-56R-Q	.B10
PH14-6F-Q	.B25
PH14-6R-Q	.B10
PH14-8F-Q	.B25
PH14-8R-Q	.B10
PH18-10F-Q	.B25
PH18-10R-Q	.B10
PH18-14R-Q	.B10
PH18-6F-Q	.B25
PH18-6R-Q	.B10
PH18-8F-Q	.B25
PH18-8R-Q	.B10
PISR1/0-1	.H32
PISR2-1	.H32
PLT1.5I-C	.K36
PLT1.5M-C	.K36
PLT1.5S-C	.K36
PLT10EH-C	.K36
PLT10LH-L	.K36
PLT13H-Q	.K36
PLT1M-C	.K36
PLT1S-C	.K36
PLT2.5H-L	.K36
PLT2.5I-C	.K36
PLT2.5S-C	.K36
PLT2H-L	.K36
PLT2I-C	.K36
PLT2M-C	.K36
PLT2S-C	.K36
PLT3H-L	.K36
PLT3I-C	.K36
PLT3S-C	.K36
PLT4.5S-C	.K36
PLT4H-L	.K36
PLT4I-C	.K36
PLT4S-C	.K36
PLT5EH-Q	.K36
PLT5H-L	.K36
PLT5S-C	.K36
PLT6EH-Q	.K36
PLT6H-L	.K36
PLT6LH-L	.K36
PLT7LH-L	.K36
PLT8H-L	.K36
PLT8LH-L	.K36
PLT9LH-L	.K36

Part Number	Page Number
-------------	-------------

PM1-3F-C	.B29
PM1-3R-C	.B28
PM1-4F-C	.B29
PM1-4R-C	.B28
PM1-5F-C	.B29
PM1-5R-C	.B28
PM1-P10-C	.B29
PM2-3F-C	.B29
PM2-3R-C	.B28
PM2-4F-C	.B29
PM2-4R-C	.B28
PM2-5F-C	.B29
PM2-5R-C	.B28
PM2-P10-C	.B29
PM6-3R-L	.B28
PM6-4R-L	.B28
PM6-5F-L	.B29
PM6-5R-L	.B28
PM6-6F-L	.B29
PM6-6R-L	.B28
PM6-8R-L	.B28
PM6-P10-L	.B29
PMNF1-3F-C	.B28
PMNF1-3R-C	.B27
PMNF1-4F-C	.B28
PMNF1-4R-C	.B27
PMNF1-5F-C	.B28
PMNF1-5R-C	.B27
PMNF1-6F-C	.B28
PMNF1-6R-C	.B27
PMNF2-3F-C	.B28
PMNF2-3R-C	.B27
PMNF2-4F-C	.B28
PMNF2-4R-C	.B27
PMNF2-5F-C	.B28
PMNF2-5R-C	.B27
PMNF2-6F-C	.B28
PMNF2-6R-C	.B27
PMNF6-3R-L	.B27
PMNF6-4F-L	.B28
PMNF6-4R-L	.B27
PMNF6-5F-L	.B28
PMNF6-5R-L	.B27
PMNF6-6F-L	.B28
PMNF6-6R-L	.B27
PMNF6-8R-L	.B27
PMV1-3FB-C	.B28
PMV1-3RB-C	.B27
PMV1-4FB-C	.B28
PMV1-4RB-C	.B27
PMV1-5FB-C	.B28
PMV1-5RB-C	.B27
PMV1-6FB-C	.B28
PMV1-6RB-C	.B27
PMV1-P10-C	.B29
PMV2-3FB-C	.B28
PMV2-3RB-C	.B27
PMV2-4FB-C	.B28
PMV2-4RB-C	.B27
PMV2-5FB-C	.B28
PMV2-5RB-C	.B27
PMV2-6FB-C	.B28
PMV2-6RB-C	.B27
PMV2-P10-C	.B29
PMV6-3R-L	.B27
PMV6-4F-L	.B28
PMV6-4R-L	.B27
PMV6-5F-L	.B28
PMV6-5R-L	.B27
PMV6-6F-L	.B28
PMV6-6R-L	.B27
PMV6-8R-L	.B27
PMV6-P10-L	.B29
PN10-10F-2K	.K7
PN10-10F-L	.B17
PN10-10FF-2K	.K11

Part Number	Page Number
-------------	-------------

PN10-10FF-L	.B22
PN10-10LF-2K	.K8
PN10-10R-2K	.K4
PN10-10R-L	.B6
PN10-10RX-L	.B6
PN10-10SLF-2K	.K10
PN10-10SLF-L	.B21
PN10-12R-L	.B6
PN10-14F-2K	.K7
PN10-14F-L	.B17
PN10-14R-2K	.K4
PN10-14R-L	.B6
PN10-14RX-L	.B6
PN10-14SLF-L	.B21
PN10-38R-2K	.K4
PN10-38R-L	.B6
PN10-38RX-L	.B6
PN10-56R-2K	.K4
PN10-56R-L	.B6
PN10-56RX-L	.B6
PN10-5SLF-L	.B21
PN10-610R-L	.B7
PN10-6F-2K	.K7
PN10-6F-L	.B17
PN10-6LF-2K	.K8
PN10-6R-2K	.K4
PN10-6R-L	.B6
PN10-6RX-L	.B6
PN10-6SLF-L	.B21
PN10-8F-2K	.K7
PN10-8F-L	.B17
PN10-8FF-2K	.K11
PN10-8FF-L	.B22
PN10-8LF-2K	.K8
PN10-8R-2K	.K4
PN10-8R-L	.B6
PN10-8RX-L	.B6
PN10-8SLF-2K	.K10
PN10-8SLF-L	.B21
PN12-10HDR-2K	.K6
PN12-10HDR-L	.B11
PN12-14HDR-2K	.K6
PN12-14HDR-L	.B11
PN12-38HDR-2K	.K6
PN12-38HDR-L	.B11
PN12-56HDR-2K	.K6
PN12-56HDR-L	.B11
PN12-6HDR-2K	.K6
PN12-8HDR-2K	.K6
PN12-8HDR-L	.B11
PN14-10F-3K	.K7
PN14-10F-C	.B17
PN14-10FF-3K	.K11
PN14-10FF-C	.B22
PN14-10FN-3K	.K7
PN14-10FN-C	.B17
PN14-10LF-3K	.K8
PN14-10LF-C	.B19
PN14-10LFN-C	.B19
PN14-10R-3K	.K4
PN14-10R-C	.B6
PN14-10RX-C	.B6
PN14-10SLF-3K	.K10
PN14-10SLF-C	.B21
PN14-12R-L	.B6
PN14-14F-3K	.K7
PN14-14F-C	.B17
PN14-14R-3K	.K4
PN14-14R-C	.B6
PN14-14RX-C	.B6
PN14-14SLF-C	.B21
PN14-38R-L	.B6
PN14-4R-3K	.K4
PN14-4R-C	.B6
PN14-56R-C	.B6
PN14-5SLF-3K	.K10

System Overview

Terminals

Disconnects

Splices

Ferrules

Compression Connectors

Crimping Tools

Mechanical Connectors

Grounding Connectors

Support Products

Technical Info

Index

PANDUIT® TERMINATION SOLUTIONS

• Type PS Tool Chart [Pages L20-L21](#)

System Overview

Part Number	Page Number	Part Number	Page Number	Part Number	Page Number
PN14-5SLF-C	.B21	PN18-8R-3K	.K4	PNF14-6SLF-3K	.K10
PN14-610R-C	.B7	PN18-8R-C	.B6	PNF14-6SLF-C	.B21
PN14-6F-3K	.K7	PN18-8SLF-3K	.K10	PNF14-8F-3K	.K7
PN14-6F-C	.B17	PN18-8SLF-C	.B21	PNF14-8F-C	.B17
PN14-6FF-3K	.K11	PN22-10R-C	.B6	PNF14-8FF-3K	.K12
PN14-6FF-C	.B22	PN22-2F-C	.B17	PNF14-8LF-3K	.K9
PN14-6FN-3K	.K7	PN22-2R-C	.B6	PNF14-8LF-C	.B19
PN14-6FN-C	.B17	PN22-4F-C	.B17	PNF14-8R-3K	.K4
PN14-6LF-3K	.K8	PN22-4R-C	.B6	PNF14-8R-C	.B7
PN14-6LF-C	.B19	PN22-6F-C	.B17	PNF14-8SLF-C	.B21
PN14-6LFW-C	.B19	PN22-6R-C	.B6	PNF18-10F-3K	.K7
PN14-6R-3K	.K4	PN22-8R-C	.B6	PNF18-10F-C	.B17
PN14-6R-C	.B6	PNF10-10F-L	.B17	PNF18-10FF-3K	.K12
PN14-6RN-3K	.K4	PNF10-10FF-2K	.K12	PNF18-10LF-3K	.K9
PN14-6RN-C	.B6	PNF10-10LF-2K	.K9	PNF18-10LF-C	.B19
PN14-6RX-C	.B6	PNF10-10LF-L	.B19	PNF18-10R-3K	.K4
PN14-6SLF-3K	.K10	PNF10-10R-2K	.K4	PNF18-10R-C	.B7
PN14-6SLF-C	.B21	PNF10-10R-L	.B7	PNF18-10SLF-3K	.K10
PN14-8F-3K	.K7	PNF10-10SLF-2K	.K10	PNF18-10SLF-C	.B21
PN14-8F-C	.B17	PNF10-10SLF-L	.B21	PNF18-14F-3K	.K7
PN14-8FF-3K	.K11	PNF10-14F-L	.B17	PNF18-14F-C	.B17
PN14-8FF-C	.B22	PNF10-14LF-2K	.K9	PNF18-14R-3K	.K4
PN14-8LF-3K	.K8	PNF10-14LF-L	.B19	PNF18-14R-C	.B7
PN14-8LF-C	.B19	PNF10-14R-2K	.K4	PNF18-38R-C	.B7
PN14-8R-3K	.K4	PNF10-14R-L	.B7	PNF18-4R-3K	.K4
PN14-8R-C	.B6	PNF10-14SLF-L	.B21	PNF18-4R-C	.B7
PN14-8RX-C	.B6	PNF10-38R-2K	.K4	PNF18-4RN-3K	.K4
PN14-8SLF-3K	.K10	PNF10-38R-L	.B7	PNF18-56R-C	.B7
PN14-8SLF-C	.B21	PNF10-56R-2K	.K4	PNF18-5SLF-3K	.K10
PN18-10F-3K	.K7	PNF10-56R-L	.B7	PNF18-5SLF-C	.B21
PN18-10F-C	.B17	PNF10-6F-2K	.K7	PNF18-6F-3K	.K7
PN18-10FF-3K	.K11	PNF10-6F-L	.B17	PNF18-6F-C	.B17
PN18-10FF-C	.B22	PNF10-6LF-2K	.K9	PNF18-6FF-3K	.K12
PN18-10FN-3K	.K7	PNF10-6LF-L	.B19	PNF18-6FN-3K	.K7
PN18-10FN-C	.B17	PNF10-6R-2K	.K4	PNF18-6LF-3K	.K9
PN18-10LF-3K	.K8	PNF10-6R-L	.B7	PNF18-6LF-C	.B19
PN18-10LF-C	.B19	PNF10-6SLF-L	.B21	PNF18-6LFW-3K	.K9
PN18-10LFN-C	.B19	PNF10-8F-2K	.K7	PNF18-6LFW-C	.B19
PN18-10R-3K	.K4	PNF10-8F-L	.B17	PNF18-6R-3K	.K4
PN18-10R-C	.B6	PNF10-8FF-2K	.K12	PNF18-6R-C	.B7
PN18-10SLF-3K	.K10	PNF10-8LF-2K	.K9	PNF18-6RN-3K	.K4
PN18-10SLF-C	.B21	PNF10-8LF-L	.B19	PNF18-6RN-C	.B7
PN18-12R-C	.B6	PNF10-8R-2K	.K4	PNF18-6SLF-3K	.K10
PN18-14F-3K	.K7	PNF10-8R-L	.B7	PNF18-6SLF-C	.B21
PN18-14F-C	.B17	PNF10-8SLF-2K	.K10	PNF18-8F-3K	.K7
PN18-14R-3K	.K4	PNF10-8SLF-L	.B21	PNF18-8F-C	.B17
PN18-14R-C	.B6	PNF14-10F-3K	.K7	PNF18-8FF-3K	.K12
PN18-38R-C	.B6	PNF14-10F-C	.B17	PNF18-8LF-3K	.K9
PN18-4R-3K	.K4	PNF14-10FF-3K	.K12	PNF18-8LF-C	.B19
PN18-4R-C	.B6	PNF14-10LF-3K	.K9	PNF18-8R-3K	.K4
PN18-4RN-C	.B6	PNF14-10LF-C	.B19	PNF18-8R-C	.B7
PN18-56R-C	.B6	PNF14-10LFN-3K	.K9	PNF18-8SLF-3K	.K10
PN18-5SLF-3K	.K10	PNF14-10R-3K	.K4	PNF18-8SLF-C	.B21
PN18-5SLF-C	.B21	PNF14-10R-C	.B7	PNL-1/0-2-L	.H14
PN18-610R-C	.B7	PNF14-10SLF-3K	.K10	PNL-1/0-L	.H12
PN18-6F-3K	.K7	PNF14-10SLF-C	.B21	PNL-1000-2-3	.H14
PN18-6F-C	.B17	PNF14-14F-C	.B17	PNL-1000-3	.H12
PN18-6FF-3K	.K11	PNF14-14R-3K	.K4	PNL-250-2-Q	.H14
PN18-6FF-C	.B22	PNF14-14R-C	.B7	PNL-250-Q	.H12
PN18-6FN-3K	.K7	PNF14-14SLF-C	.B21	PNL-4-C	.H12
PN18-6FN-C	.B17	PNF14-38R-L	.B7	PNL-500-2-3	.H14
PN18-6LF-3K	.K8	PNF14-4R-3K	.K4	PNL-500-3	.H12
PN18-6LF-C	.B19	PNF14-4R-C	.B7	PNL-8-C	.H12
PN18-6LFW-C	.B19	PNF14-56R-C	.B7	PNLC-1/0-3	.H17
PN18-6R-3K	.K4	PNF14-5SLF-C	.B21	PNLC-250-1	.H17
PN18-6R-C	.B6	PNF14-6F-3K	.K7	PNLC-500-1	.H17
PN18-6RN-3K	.K4	PNF14-6F-C	.B17	PROG-EMCD	.K31
PN18-6RN-C	.B6	PNF14-6FF-3K	.K12	PROG-WIN2CD	.K31
PN18-6SLF-3K	.K10	PNF14-6FN-3K	.K7	PS1-E	.F63
PN18-6SLF-C	.B21	PNF14-6LF-3K	.K9	PS1/0-X	.F63
PN18-8F-3K	.K7	PNF14-6LF-C	.B19	PS12-L	.D6
PN18-8F-C	.B17	PNF14-6LFW-C	.B19	PS16-C	.D6
PN18-8FF-3K	.K11	PNF14-6R-3K	.K4	PS18-C	.D6
PN18-8FF-C	.B22	PNF14-6R-C	.B7	PS2-Q	.F63
PN18-8LF-3K	.K8	PNF14-6RN-3K	.K4	PS2/0-X	.F63
PN18-8LF-C	.B19	PNF14-6RN-C	.B7	PS3/0-X	.F63

PANDUIT® TERMINATION SOLUTIONS

• Type PS Tool Chart Pages L20-L21

Part Number	Page Number
PS4-L	F63
PS4/0-X	F63
PS6-L	F63
PS8-L	F63
PSN12-L	D6
PSN16-C	D6
PSN18-C	D6
PT10-10R-L	B10
PT10-14R-L	B10
PT10-6R-L	B10
PT10-8R-L	B10
PT14-10R-C	B10
PT14-14R-C	B10
PT14-4R-C	B10
PT14-6R-C	B10
PT14-8R-C	B10
PT18-10R-C	B10
PT18-14R-C	B10
PT18-4R-C	B10
PT18-6R-C	B10
PT18-8R-C	B10
PV10-10F-L	B18
PV10-10FB-2K	K8
PV10-10FF-L	B22
PV10-10FFB-2K	K12
PV10-10FX-L	B18
PV10-10LF-L	B20
PV10-10LFB-2K	K9
PV10-10LFX-L	B20
PV10-10R-L	B8
PV10-10RB-2K	K5
PV10-10RX-L	B9
PV10-10SLF-L	B22
PV10-10SLFB-2K	K11
PV10-12R-L	B8
PV10-14F-L	B18
PV10-14FB-2K	K8
PV10-14FX-L	B18
PV10-14LF-L	B20
PV10-14LFB-2K	K9
PV10-14LFX-L	B20
PV10-14R-L	B8
PV10-14RB-2K	K5
PV10-14RX-L	B9
PV10-14SLF-L	B22
PV10-38R-L	B8
PV10-38RB-2K	K5
PV10-38RX-L	B9
PV10-56R-L	B8
PV10-56RB-2K	K5
PV10-56RX-L	B9
PV10-5SLF-L	B22
PV10-610R-L	B9
PV10-610RB-2K	K5
PV10-6F-L	B18
PV10-6FB-2K	K8
PV10-6LF-L	B20
PV10-6LFB-2K	K9
PV10-6LFX-L	B20
PV10-6R-L	B8
PV10-6RB-2K	K5
PV10-6RX-L	B9
PV10-6SLF-L	B22
PV10-6SLFB-2K	K11
PV10-8F-L	B18
PV10-8FB-2K	K8
PV10-8FF-L	B22
PV10-8FFB-2K	K12
PV10-8FX-L	B18
PV10-8LF-L	B20
PV10-8LFB-2K	K9
PV10-8LFX-L	B20
PV10-8R-L	B8
PV10-8RB-2K	K5
PV10-8RX-L	B9
PV10-8SLF-L	B22

Part Number	Page Number
PV10-8SLFB-2K	K11
PV10-P55-L	C9
PV12-10HDR-L	B11
PV12-10HDRB-2K	K6
PV12-10HDRX-L	B11
PV12-14HDR-L	B11
PV12-14HDRB-2K	K6
PV12-14HDRX-L	B11
PV12-38HDR-L	B11
PV12-38HDRB-2K	K6
PV12-38HDRX-L	B11
PV12-56HDR-L	B11
PV12-56HDRB-2K	K6
PV12-56HDRX-L	B11
PV12-6HDR-L	B11
PV12-6HDRX-L	B11
PV12-6HDRB-2K	K6
PV12-8HDR-L	B11
PV12-8HDRX-L	B11
PV12-8HDRB-2K	K6
PV14-10F-C	B18
PV14-10FB-3K	K8
PV14-10FF-C	B22
PV14-10FFB-3K	K12
PV14-10FN-C	B18
PV14-10FNB-3K	K8
PV14-10FX-C	B18
PV14-10LF-C	B20
PV14-10LFB-3K	K9
PV14-10LFN-C	B20
PV14-10LFX-C	B20
PV14-10R-C	B8
PV14-10RB-3K	K5
PV14-10RX-C	B9
PV14-10SLF-C	B22
PV14-10SLFB-3K	K11
PV14-12R-L	B8
PV14-14F-C	B18
PV14-14FB-3K	K8
PV14-14R-C	B8
PV14-14RB-3K	K5
PV14-14RX-C	B9
PV14-14SLF-C	B22
PV14-14SLFB-3K	K11
PV14-38R-L	B8
PV14-38RB-2K	K5
PV14-38RX-L	B9
PV14-4R-C	B8
PV14-4RB-3K	K5
PV14-4RX-C	B9
PV14-56R-C	B8
PV14-56RB-2K	K5
PV14-56RX-C	B9
PV14-5SLF-C	B22
PV14-610R-C	B9
PV14-610RB-3K	K5
PV14-6F-C	B18
PV14-6FB-3K	K8
PV14-6FF-C	B22
PV14-6FFB-3K	K12
PV14-6FN-C	B18
PV14-6FNB-3K	K8
PV14-6FX-C	B18
PV14-6LF-C	B20
PV14-6LFB-3K	K9
PV14-6LFW-C	B20
PV14-6LFWB-3K	K9
PV14-6LFX-C	B20
PV14-6R-C	B8
PV14-6RB-3K	K5
PV14-6RN-C	B8
PV14-6RNB-3K	K5
PV14-6RX-C	B9
PV14-6SLF-C	B22
PV14-6SLFB-3K	K11
PV14-8F-C	B18

Part Number	Page Number
PV14-8FB-3K	K8
PV14-8FF-C	B22
PV14-8FFB-3K	K12
PV14-8FX-C	B18
PV14-8LF-C	B20
PV14-8LFB-3K	K9
PV14-8LFX-C	B20
PV14-8R-C	B8
PV14-8RB-3K	K5
PV14-8RX-C	B9
PV14-8SLF-C	B22
PV14-8SLFB-3K	K11
PV14-P47-C	C9
PV14-P47B-3K	K13
PV18-10F-C	B18
PV18-10FB-3K	K8
PV18-10FF-C	B22
PV18-10FFB-3K	K12
PV18-10FN-C	B18
PV18-10FX-C	B18
PV18-10LF-C	B20
PV18-10LFB-3K	K9
PV18-10LFN-C	B20
PV18-10LFNB-3K	K9
PV18-10LFX-C	B20
PV18-10R-C	B8
PV18-10RB-3K	K5
PV18-10RX-C	B9
PV18-10SLF-C	B22
PV18-10SLFB-3K	K11
PV18-12R-C	B8
PV18-14FB-3K	K8
PV18-14R-C	B8
PV18-14RB-3K	K5
PV18-14RX-C	B9
PV18-38R-C	B8
PV18-38RB-2K	K5
PV18-38RX-C	B9
PV18-4R-C	B8
PV18-4RB-3K	K5
PV18-4RX-C	B9
PV18-56R-C	B8
PV18-56RB-2K	K5
PV18-56RX-C	B9
PV18-5SLF-C	B22
PV18-5SLFB-3K	K11
PV18-610R-C	B9
PV18-610RB-3K	K5
PV18-6F-C	B18
PV18-6FB-3K	K8
PV18-6FF-C	B22
PV18-6FFB-3K	K12
PV18-6FN-C	B18
PV18-6FNB-3K	K8
PV18-6FX-C	B18
PV18-6LF-C	B20
PV18-6LFB-3K	K9
PV18-6LFW-C	B20
PV18-6LFWB-3K	K9
PV18-6LFX-C	B20
PV18-6R-C	B8
PV18-6RB-3K	K5
PV18-6RNB-3K	K5
PV18-6RX-C	B9
PV18-6SLF-C	B22
PV18-6SLFB-3K	K11
PV18-8F-C	B18
PV18-8FB-3K	K8
PV18-8FFB-3K	K12
PV18-8FF-C	B22
PV18-8LFB-3K	K9
PV18-8LFX-C	B20
PV18-8R-C	B8

System Overview

Terminals

Disconnects

Splices

Ferrules

Compression Connectors

Crimping Tools

Mechanical Connectors

Grounding Connectors

Support Products

Technical Info

Index

PANDUIT® TERMINATION SOLUTIONS

• Type RSC Tool Chart [Pages L26-L31](#)
 • Type SA Tool Chart [Pages L40-L41](#)

• Type SAR Tool Chart [Page L36](#)

System Overview	Part Number	Page Number	Part Number	Page Number	Part Number	Page Number	
Terminals	PV18-8RB-3K	.K5	RSC4/0-1/0-X	.F104	S2-12R-X	.B16	
	PV18-8RX-C	.B9	RSC4/0-2/0-X	.F104	S2-14R-X	.B16	
	PV18-8SLF-C	.B22	RSC4/0-4-X	.F104	S2-38R-X	.B16	
	PV18-8SLFB-3K	.K11	RSC4/0-6-X	.F104	S2-56R-X	.B16	
	PV18-P47-C	.C9	RSC500-X350-6	.F104	S2/0-12R-X	.B16	
	PV18-P47B-3K	.K13	RSC500-X4/0-6	.F104	S2/0-14R-X	.B16	
	PV2-10R-X	.B12	RSC750-4/0-6	.F104	S2/0-38R-X	.B16	
	PV2-10RX-X	.B12	RSC750-500-6	.F104	S2/0-56R-X	.B16	
	PV2-12R-X	.B12	RSC750-750-6	.F104	S2/0-76R-X	.B16	
	PV2-12RX-X	.B12	RSC750-X350-6	.F104	S200X225VA6	.K33	
Disconnects	PV2-14R-X	.B12	RSC750-X4/0-6	.F104	S200X225YAJ	.K32	
	PV2-14RX-X	.B12	RSC750-X500-6	.F104	S200X400VA1	.K32	
	PV2-38R-X	.B12	RSCK1/0-4-1	.F102	S200X400VA6	.K33	
	PV2-38RX-X	.B12	RSCK1/0-6-1	.F102	S200X400YAJ	.K32	
	PV2-56R-X	.B12	RSCK2-4-1	.F102	S200X650VA1	.K32	
	PV2-56RX-X	.B12	RSCK2-6-1	.F102	S200X650VA6	.K33	
	PV22-10R-C	.B8	RSCK2/0-4-1	.F102	S200X650YAJ	.K32	
	PV22-2F-C	.B18	RSCK2/0-6-1	.F102	S250-12R-5	.B16	
	PV22-2R-C	.B8	RSCK4-6-1	.F102	S250-38R-5	.B16	
	PV22-4F-C	.B18	RSCK4/0-1/0-1	.F103	S250-56R-5	.B16	
Splices	PV22-4R-C	.B8	RSCK4/0-2/0-1	.F103	S250-76R-5	.B16	
	PV22-6F-C	.B18	RSCK4/0-4-1	.F102	S3/0-12R-5	.B16	
	PV22-6R-C	.B8	RSCK4/0-6-1	.F102	S3/0-14R-5	.B16	
	PV22-8R-C	.B8	RSCK500-X350-1	.F103	S3/0-38R-5	.B16	
	PV4-10R-E	.B12	RSCK500-X4/0-1	.F103	S3/0-56R-5	.B16	
	PV4-10RX-E	.B12	RSCK750-4/0-1	.F103	S3/0-76R-5	.B16	
	PV4-12R-E	.B12	RSCK750-500-1	.F103	S4-10R-E	.B16	
	PV4-12RX-E	.B12	RSCK750-750-1	.F103	S4-14R-E	.B16	
	PV4-14R-E	.B12	RSCK750-X350-1	.F103	S4-38R-E	.B16	
	PV4-14RX-E	.B12	RSCK750-X4/0-1	.F103	S4-56R-E	.B16	
Ferrules	PV4-38R-E	.B12	RSCK750-X500-1	.F103	S4/0-12R-5	.B16	
	PV4-38RX-E	.B12	RSCKX750-4/0-1	.F103	S4/0-38R-5	.B16	
	PV4-56R-E	.B12	RSCKX750-750-1	.F103	S4/0-56R-5	.B16	
	PV4-56RX-E	.B12	RSCX750-4/0-3	.F104	S4/0-76R-5	.B16	
	PV6-10R-E	.B12	RSCX750-750-3	.F104	S6-10R-E	.B16	
	PV6-10RX-E	.B12			S6-14R-E	.B16	
	PV6-12R-E	.B12	S		S6-38R-E	.B16	
	PV6-12RX-E	.B12	S050X075VA1	.K32	S6-56R-E	.B16	
	PV6-14R-E	.B12	S050x075VA3	.K33	S8-10R-Q	.B16	
	PV6-14RX-E	.B12	S050X075VA6	.K33	S8-14R-Q	.B16	
Compression Connectors	PV6-38R-E	.B12	S050X075YAJ	.K32	S8-38R-Q	.B16	
	PV6-38RX-E	.B12	S050X125VA1	.K32	S8-56R-Q	.B16	
	PV6-56R-E	.B12	S050X125VA3	.K33	SA1-X	.F115	
	PV6-56RX-E	.B12	S050X125VA6	.K33	SA1/0-X	.F115	
	PV6-8R-E	.B12	S050X125YAJ	.K32	SA1000-1	.F115	
	PV6-8RX-E	.B12	S050X150VA1	.K32	SA2-X	.F115	
	PV8-10R-Q	.B12	S050X150VA3	.K33	SA2/0-5	.F115	
	PV8-10RX-Q	.B12	S050X150VA6	.K33	SA250-5	.F115	
	PV8-12R-Q	.B12	S050X150YAJ	.K32	SA3/0-5	.F115	
	PV8-12RX-Q	.B12	S1/0-12R-X	.B16	SA300-2	.F115	
Crimping Tools	PV8-14R-Q	.B12	S1/0-14R-X	.B16	SA350-2	.F115	
	PV8-14RX-Q	.B12	S1/0-38R-X	.B16	SA4-X	.F115	
	PV8-18R-Q	.B12	S1/0-56R-X	.B16	SA4/0-5	.F115	
	PV8-18RX-Q	.B12	S100X075VA1	.K32	SA400-2	.F115	
	PV8-38R-Q	.B12	S100X075VA3	.K33	SA500-2	.F115	
	PV8-38RX-Q	.B12	S100X075VA6	.K33	SA6-X	.F115	
	PV8-56R-Q	.B12	S100X075YAJ	.K32	SA600-2	.F115	
	PV8-56RX-Q	.B12	S100X125VA1	.K32	SA750-1	.F115	
	PV8-8R-Q	.B12	S100X125VA3	.K33	SA800-1	.F115	
	PV8-8RX-Q	.B12	S100X125VA6	.K33	SAR1/0-2-X	.F116	
Mechanical Connectors	RMH2BL	.K30	S100X125YAJ	.K32	SAR2-4-X	.F116	
	RMH4BL	.K30	S100X150VA1	.K32	SAR3/0-1/0-5	.F116	
	RMR2BL	.K30	S100X150VA3	.K33	SAR350-4/0-2	.F116	
	RMR2WH	.K30	S100X150VA6	.K33	SAR4/0-2/0-5	.F116	
	RMR4BL	.K30	S100X150YAJ	.K32	SAR500-350-2	.F116	
	RMR4BU	.K30	S100X225VA1	.K32	SAR600-500-2	.F116	
	RMR4GR	.K30	S100X225VA3	.K33	SAR750-600-2	.F116	
	RMR4RD	.K30	S100X225VA6	.K33	SBA1/0-Q	.H9	
	RMR4VWH	.K30	S100X225YAJ	.K32	SBA2-C	.H9	
	RMW2BL	.K30	S100X400VA1	.K32	SBA2/0-Q	.H9	
Grounding Connectors	RMW4BL	.K30	S100X400VA6	.K33	SBA350-1	.H9	
	RSC1/0-4-X	.F104	S100X400YAJ	.K32	SBA4-C	.H9	
	RSC2-4-Q	.F104	S100X650VA1	.K32	SBA4/0-Q	.H9	
	RSC2-6-Q	.F104	S100X650VA6	.K33	SBA500-1	.H9	
	RSC2/0-4-X	.F104	S100X650YAJ	.K32	SBA6-C	.H9	
	RSC2/0-6-X	.F104	S200X225VA1	.K32	SBC1/0-L	.H7	
	RSC4-6-L	.F104	S2-10R-X	.B16			
	Support Products						
Technical Info							
Index							

PANDUIT® TERMINATION SOLUTIONS

- Type SCH Tool Chart [Pages L16-L17](#)
- Type SCL Tool Chart [Pages L12-L15](#)
- Type SCS Tool Chart [Pages L8-L11](#)

- Type SCSF Tool Chart [Pages L24-L25](#)
- Type SCSS Tool Chart [Pages L6-L7](#)
- Type SCT Tool Chart [Pages L18-L19](#)

Part Number	Page Number
-------------	-------------

SBC1000-1	.H7
SBC2-C	.H7
SBC2/0-Q	.H7
SBC250-Q	.H7
SBC2L-C	.H7
SBC3-C	.H7
SBC3/0-Q	.H7
SBC350-1	.H7
SBC4S-C	.H7
SBC4SL-C	.H7
SBC500-1	.H7
SBC6S-C	.H7
SBC6SL-C	.H7
SBC750-1	.H7
SBC8-C	.H7
SBC8L-C	.H7
SBCT1/0-L	.H8
SBCT10-C	.H8
SBCT1000-1	.H8
SBCT2-C	.H8
SBCT2/0-Q	.H8
SBCT250-Q	.H8
SBCT3-C	.H8
SBCT3/0-Q	.H8
SBCT350-1	.H8
SBCT500-1	.H8
SBCT6-C	.H8
SBCT750-1	.H8
SBCT8-C	.H8
SCH1-E	.F61
SCH1/0-X	.F61
SCH1000-3	.F61
SCH2-Q	.F61
SCH2/0-X	.F61
SCH250-X	.F61
SCH3/0-X	.F61
SCH300-X	.F61
SCH350-X	.F61
SCH4-L	.F61
SCH4/0-X	.F61
SCH500-6	.F61
SCH6-L	.F61
SCH750-6	.F61
SCL1-E	.F60
SCL1/0-X	.F60
SCL1000-3	.F60
SCL2-Q	.F60
SCL2/0-X	.F60
SCL250-X	.F60
SCL3/0-X	.F60
SCL300-X	.F60
SCL350-X	.F60
SCL4-L	.F60
SCL4/0-X	.F60
SCL400-6	.F60
SCL500-6	.F60
SCL6-L	.F60
SCL600-6	.F60
SCL750-6	.F60
SCL8-L	.F60
SCS1-E	.F59
SCS1/0-X	.F59
SCS1000-3	.F59
SCS2-Q	.F59
SCS2/0-X	.F59
SCS250-X	.F59
SCS3/0-X	.F59
SCS300-X	.F59
SCS350-X	.F59
SCS4-L	.F59
SCS4/0-X	.F59
SCS400-6	.F59
SCS500-6	.F59
SCS6-L	.F59
SCS600-6	.F59
SCS750-6	.F59

Part Number	Page Number
-------------	-------------

SCS8-L	.F59
SCSF1-X	.F101
SCSF1/0-X	.F101
SCSF2-E	.F101
SCSF2/0-X	.F101
SCSF250-X	.F101
SCSF3/0-X	.F101
SCSF300-6	.F101
SCSF350-6	.F101
SCSF4-L	.F101
SCSF4/0-X	.F101
SCSF6-L	.F101
SCSF8-L	.F101
SCSS1-Q	.F58
SCSS1/0-X	.F58
SCSS2-Q	.F58
SCSS2/0-X	.F58
SCSS250-X	.F58
SCSS3/0-X	.F58
SCSS4-L	.F58
SCSS4/0-X	.F58
SCSS6-L	.F58
SCSS8-L	.F58
SCT1/0-1/0	.F62
SCT2-2	.F62
SCT2/0-2/0	.F62
SCT250-250	.F62
SCT300-300	.F62
SCT350-350	.F62
SCT4/0-1/0	.F62
SCT4/0-4/0	.F62
SCT500-4/0	.F62
SCT500-500	.F62
SP1-1/0-L	.J5
SP1-1/0L-L	.J5
SP1-2-C	.J5
SP1-2/0-Q	.J5
SP1-2/0L-Q	.J5
SP1-2L-C	.J5
SP1-3-C	.J5
SP1-350-12	.J5
SP1-350L-12	.J5
SP1-3L-C	.J5
SP1-4-C	.J5
SP1-4/0-Q	.J5
SP1-4/0L-Q	.J5
SP1-4L-C	.J5
SP1-500-12	.J5
SP1-500L-12	.J5
SP1-7-C	.J5
SP1-7L-C	.J5
SP1-8-C	.J5
SP1-8L-C	.J5
SP2-1/0-L	.J6
SP2-1/0L-L	.J6
SP2-2-C	.J6
SP2-2/0-Q	.J6
SP2-2/0L-Q	.J6
SP2-2L-C	.J6
SP2-3-C	.J6
SP2-350-12	.J6
SP2-350L-12	.J6
SP2-3L-C	.J6
SP2-4-C	.J6
SP2-4/0-Q	.J6
SP2-4/0L-Q	.J6
SP2-4L-C	.J6
SP2-500-12	.J6
SP2-500L-12	.J6
SP2-7-C	.J6
SP2-7L-C	.J6
SP2-8-C	.J6
SP2-8L-C	.J6
SPF1-1/0-L	.J7
SPF1-2-C	.J7
SPF1-2/0-Q	.J7

Part Number	Page Number
-------------	-------------

SPF1-3-C	.J7
SPF1-350-12	.J7
SPF1-4-C	.J7
SPF1-4/0-Q	.J7
SPF1-500-12	.J7
SPF1-7-C	.J7
SPF1-8-C	.J7
SPF2-1/0-L	.J8
SPF2-2-C	.J8
SPF2-2/0-Q	.J8
SPF2-3-C	.J8
SPF2-350-12	.J8
SPF2-4-C	.J8
SPF2-4/0-Q	.J8
SPF2-500-12	.J8
SPF2-7-C	.J8
SPF2-8-C	.J8
SR-0-X	.H29
SR-1000-1	.H29
SR-2-X	.H29
SR-250-X	.H29
SR-350-X	.H29
SR-4/0-X	.H29
SR-500-3	.H29
SR-750-1	.H29
SR2	.B31
SR4	.B31
SR6	.B31
SS-1	.G28
SS-1GAGE	.G28
ST2EH	.K41
STH2	.K41
STS2	.K41
T	
TAPC2-2/0-X	.F106
TAPC3/0-4/0-5	.F106
TAPC500-2	.F106
TDP43M	.K30
TDP43M-RS	.K30
TTS-20R0	.K40
TTS-35RX0	.K40
U	
UCT3S-X0	.K40
UCT5S-X0	.K40
UCTGS1224-X	.K40
UCTGSM5-X	.K40
UCTGSM6-X	.K40
UGCTC3S-X0	.K40
UGCTC5S-X0	.K40
UGCTE3S-X0	.K40
UGCTE5S-X0	.K40
V	
VT-0-Q	.H9
VT-1-Q	.H9
VT-2-Q	.H9
VT-3-12	.H9
VT-4-12	.H9
VT-5-6	.H9
VT-6-6	.H9
VTA-0-Q	.H10
VTA-1-Q	.H10
VTA-2-Q	.H10
VTA-3-12	.H10
VTA-4-12	.H10
VTA-5-6	.H10
VTA-6-6	.H10
W	
WB12-L	.J11
WB34-X	.J11
WB58-Q	.J11

System Overview

Terminals

Disconnects

Splices

Ferrules

Compression Connectors

Crimping Tools

Mechanical Connectors

Grounding Connectors

Support Products

Technical Info

Index

PANDUIT® is a global leader in wiring and communication products, delivering end-to-end solutions in support of demanding electrical and networking requirements.

PANDUIT® Catalogs

Cable Ties

SA-CTCB03

- *PAN-TY*® Cable Ties
- *PAN-TY*® Clamp Ties
- *PAN-TY*® Push Mount Ties
- *PAN-TY*® Marker Ties
- *DOVE-TOP*® Barb Ty Cable Ties
- *DOVE-TOP*® Barb Ty Clamp Ties
- *DOVE-TOP*® Barb Ty Marker Ties
- *CONTOUR-TY*™ Cable Ties
- *DURA-TY*™ Cable Ties
- *BELT-TY*™ In-Line Cable Ties
- *TAK-TY*® Hook & Loop Cable Ties
- *STA-STRAP*® Cable Ties
- Cable Tie Installation Tools
- Custom Hot Stamping

Wiring Duct

SA-WDCB05

- *PANDUCT*® Slotted Wall Wiring Duct
- *PANDUCT*® Solid Wall Raceway
- *PANDUCT*® Halogen Free Slotted Wall Wiring Duct
- *PANDUCT*® Flush Cover Round Hole Wiring Duct
- *PANDUCT*® Hinged Slotted Wall Wiring Duct
- *PANDUCT*® Flexible Wiring Duct
- *PANDUCT*® Low Smoke Slotted Wall Wiring Duct
- Wiring Duct Accessories and Installation Tools

Wiring Accessories/Abrasion Protection

SA-CTCB03

- Adhesive Backed Cable Tie Mounts
- Screw Applied Cable Tie Mounts
- Flat Cable Mounts
- Fixed Diameter Clamps
- Harness Board Accessories
- Spiral Wrap
- Grommet Edging
- Braided Expandable Sleeving
- Corrugated Loom Tubing and Fittings
- Heat Shrink Tubing
- Non-Shrink PVC Tubing
- *PAN-WRAP*™ Split Harness Wrap

Stainless Steel Products

SA-SSCB06

- *PAN-STEEL*® Stainless Steel Cable Ties
- *PAN-STEEL*® Stainless Steel Strapping
- Installation Tools
- *PAN-STEEL*® System Accessories
- *PAN-STEEL*® System Permanent Identification

Identification Products

SA-IDCB16

- Hand-Held Printers
- Desktop Printers
- Labeling Software
- Computer Printable Labels
- Wire Markers
- Lockout/Tagout Products
- Voltage Markers
- Warning Labels
- Safety Signs and Tags
- Letters and Numbers

Surface Raceway

SA-SRCB02

- Office Furniture Raceway
- Cove Raceway
- *PAN-WAY*® TG-70 Surface Raceway
- *PAN-WAY*® T-70 & Twin-70 Surface Raceway
- *PAN-WAY*® T-45 Surface Raceway
- *ULTIMATE ID*™ Network Labeling System
- Faceplates, Surface Mount Outlet Boxes & Labeling Administration
- *PAN-WAY*® LD Profile Surface Raceway
- *PAN-WAY*® T130 Surface Raceway
- *PAN-POLE*™ Outlet Poles

Network Connectivity

SA-NCCB04

- Modules
- *ULTIMATE ID*™ System
- Work Area
- Zone Cabling
- Patch Panels, Copper Patch Cords & Punchdowns
- Fiber Connectors, Enclosures & Patch Cords
- Racks & Cable Management
- Grounding and Bonding
- Fiber Routing
- Surface Raceway
- Labeling & Administration
- Cable Ties & Accessories